

IHRE SPEZIALISTEN FÜR MASCHINENMESSER
YOUR SPECIALISTS FOR MACHINE KNIVES



MEISTER
STÜCKE
MASTER
PIECES

INHALTSVERZEICHNIS INDEX

INFORMATION
INFORMATION

2 - 7

PAPIERSCHNEIDMESSER
PAPER CUTTING KNIVES



8 - 204

SCHNEIDLEISTEN
CUTTING STICKS



205 - 219

EISHOBELMESSER
ICE SCRAPERS



220 - 222

MESSER FÜR SCHULHEFTSTRASSEN
KNIVES FOR BOUND NOTEBOOK PRODUCTION LINES



223 - 242

QUERSCHNEIDMESSER
SHEETER KNIVES



244

MESSER FÜR VERPACKUNGSMASCHINEN
KNIVES FOR PACKAGING EQUIPMENT



245

SCHERENMESSER FÜR METALLBEARBEITUNG
SHEAR BLADES FOR METAL-WORKING



246 - 247

KREISMESSER
CIRCULAR KNIVES

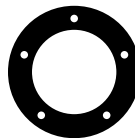

248 - 253

STANDARD-VERPACKUNG
STANDARD PACKING



254 - 255

VERKAUFS- UND LIEFERBEDINGUNGEN
SALES TERMS AND DELIVERY CONDITIONS

256

INFORMATION

PAPIERSCHNEIDEMESSER FÜR ALLE MASCHINEN AB LAGER

Messer und Maschine bilden eine Einheit.

Darum hängt nicht zuletzt die Leistung jeder modernen Papierschneidemaschine von der Qualität des Papierschneidemessers ab.

Wir als die Messer-Spezialisten wählen die geeigneten Werkstoffe aus, sorgen für eine optimale Warmbehandlung und für eine präzise mechanische Bearbeitung.

Erst die richtige Wahl dieser drei Komponenten machen aus einem Messer ein Präzisionsschneidwerkzeug, welches den Anforderungen der heutigen modernen und programmgesteuerten Papierschneidemaschinen gerecht werden kann.

Wir von FASSCO haben für jeden Einsatz das richtige Messer und garantieren für jedes von uns produzierte Stück.

Wählen Sie die richtige Qualität. Die Wirtschaftlichkeit sollte beim Kauf eines Messers den Ausschlag geben.

FASSCO-Garantie, das ist:

Qualität - Genauigkeit - Passung.

FASSCO-HOCHLEISTUNGS- PAPIERSCHNEIDEMESSER

werden in gebrauchsfertiger Ausführung geliefert, fachgerecht gehärtet und angelassen, präzise maschinell plangeschliffen, scharfgeschliffen und abgezogen.

Bei Bestellungen aus diesem Katalog genügt die Angabe der FASSCO-Nummer mit der Qualitäts-Kurzbezeichnung.

PAPER CUTTING KNIVES FOR ALL MACHINES EX STOCK

Knife and machine constitute one unity.

Therefore the efficiency of each paper cutting machine is last not least dependent on the quality of the paper cutting knife.

We, the knife-specialists, select the best suited materials, provide for optimum heat-treatment and for precise mechanical working.

Only the appropriate selection of these three components turns a knife into a precision cutting tool, which meets the requirements of the today's modern and programmed paper cutting machines.

FASSCO has the best suited knife for each employment and we guarantee each piece of our production.

Please choose the correct quality. When buying a knife the efficiency should turn the scale.

FASSCO-guarantee, that means:
quality - precision - fit.

HEAVY-DUTY FASSCO PAPER CUTTING KNIVES

will be delivered ready for use, skillfully hardened and tempered, precision surface ground, sharpened.

In case of orders from this list it is sufficient to indicate the FASSCO Number with the short symbol of Quality.

PLANSCHNEIDEMESSER

FASSCO-Planschneidemesser für alle Papierschneidemaschinen entsprechen den heutigen Anforderungen zum Schneiden von allen Papieren, Pappen, Folien usw. Für höchste Ansprüche und längste Standzeiten empfehlen wir unsere Qualität F-3000.

DREISCHNEIDEMESSER

An Dreischneidemessern werden besondere Anforderungen gestellt. Häufiger Stillstand durch Ein- und Ausbau der Messer sollte vermieden werden. Unsere spezielle Qualität F-3000 ist auch die richtige für Ihren Dreischneider. Jeder zweite FASSCO-Dreischneidersatz trägt diese Qualitätsbezeichnung.

TRIMMERMESSER

hohe Leistung... lange Standzeit... selten umrüsten

Das sind die Anforderungen, die an jedes am Fließband eingesetztes Teil gestellt werden. FASSCO hat die Qualitäten, die diesen Anforderungen voll gerecht werden, im praktischen Einsatz erprobt und bewährt.

PAPER CUTTING KNIVES (FACE TRIMMING)

FASSCO paper cutting knives (face trimming) for all paper cutting machines meet all today's requirements for cutting of all kinds of paper, cardboards, foils etc. For highest demands and longest endurance we recommend our quality F-3000.

THREE KNIFE TRIMMER

One makes special demands on three-knife trimmers. When mounting and dismounting the knives an often standstill should be avoided. Our special quality F-3000 is the right one for your Three-knife-trimmer. Every second FASSCO Three-knife-trimmer set is equipped with this quality marking.

TRIMMER KNIVES

high efficiency... long endurance... seldom reset

These are the demands, which were made to every part, set up the assembly line. FASSCO offers the qualities, which meet all requirements, proved in practical service and always successful.



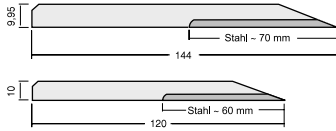

Papierschneidmesser FASSCO „F-220“ Standardqualität

Seit über 80 Jahren produzieren wir Messer für Papierschneidemaschinen aus einem 2-Komponentenstahl (Stahl auf Eisen). Die Qualität des gehärteten Schnittstahls ist bewährt und für universellen Einsatz geeignet.

Weitere Vorteile:

1. Der eingelegte Stahl ist breiter als die Nachstellmöglichkeit in der Schneidemaschine. Viele Messer haben deshalb 2 oder 3 Lochreihen.
2. Bei sachgemäßem Nachschleifen behält das Messer seine Geradlinigkeit bis es aufgenutzt ist.

Paper Cutting Knives FASSCO "F-220" Standard Quality

Since more than 80 years we manufacture knives for paper cutting machines from inlaid tool steel. The quality of the hardened cutting steel is well-proved and suitable for universal use.

Further advantages:

1. The inserted steel is wider than reset in cutting machine. Therefore a lot of knives have 2 or 3 rows of holes.
2. If knife will be reground properly, it maintains its straightness until used up.

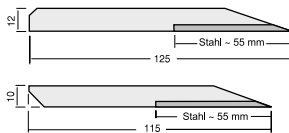

Papierschneidmesser FASSCO „F-3000 MICRO FINISH“ (HSS 18% W.)

Wir liefern diese Qualität seit mehr als 30 Jahren. Unsere Umsätze steigen kontinuierlich.

Vorteile:

1. Der eingelegte Stahl ist breiter als die Nachstellmöglichkeit in der Schneidemaschine. Viele Messer haben deshalb 2 oder 3 Lochreihen.
2. Bei sachgemäßem Nachschleifen behält das Messer seine Geradlinigkeit bis es aufgenutzt ist.
3. Die Nachschleifkosten sind gering.
ca. 70% höhere Preise als F-220
ca. 300-500% höhere Schnittleistung.

Paper Cutting Knives FASSCO "F-3000 MICRO FINISH" (HSS 18% T.)

Since more than 30 years we supply this quality. Our sales grow continuously.

Advantages:

1. The inserted steel is wider than reset in cutting machine. Therefore a lot of knives have 2 or 3 rows of holes.
2. If knife will be reground properly, it maintains its straightness until used up.
3. Low regrinding-costs.
approx. 70% higher prices than F-220.
approx. 300-500% higher cutting result.

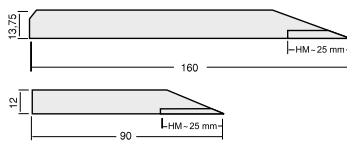

Papierschneidmesser FASSCO „F-8000 HARTMETALL“

Diese allgemein bekannte Qualität empfehlen wir zum Schneiden von Großserien bei immer gleicher Papiersorte.

Es ist zu berücksichtigen:

1. Die Abnutzung des Hartmetalls ist max. 25 mm.
2. Nach mehrmaligem Nachschleifen muß das Messer nachgerichtet werden.

Die Gesamtkosten sind höher als bei anderen Qualitäten, deshalb sollte ein Kosten-Leistungsvergleich gemacht werden.

FASSCO F-8000 HM
FASSCO F-8020 MICRO
FASSCO F-8040 MICRO PLUS

Paper Cutting Knives FASSCO "F-8000 TUNGSTEN CARBIDE"

We recommend this well-known quality for cutting quantities of always same kind of paper.

Please take into consideration:

1. worn-out of tungsten carbide is max. 25 mm.
2. after repeated regrinding knives have to be redressed.

The total costs are higher than for all other qualities. Therefore costs and efficiency should be compared.

FASSCO F-8000 HM
FASSCO F-8020 MICRO
FASSCO F-8040 MICRO PLUS

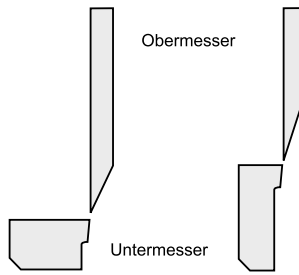

**Papierschnidmesser
FASSCO „F-236“
12% Chromstahl (Vollstahl)**

Diese Qualität hat sich weltweit bewährt und wird ausschließlich im Scherenschnitt eingesetzt (Ober- und Untermesser).

Für alle Trimmer-Messer ist eine Parallelität von 0,01 - 0,02 mm erforderlichlich.

**Paper Cutting Knives
FASSCO “F-236”
High Carbon - High Chrome
(Solid Steel)**

This quality - world-wide proved - will be used in shearing cut only (Upper and lower knives).

All trimming knives should have parallelism max. 0,01 - 0,02 mm (.0004" - .0008").



**Schneidleisten
DIE GELBE LEISTE – VON FASSCO**

- ob Standard F-220
- ob hochlegiert F-3000
- ob Hartmetall F-8000

für alle Messerqualitäten

- Messerschonend
- Hohe Präzision
- Höhere Schnittzahlen
- Hohe Schneidqualität
- Umweltfreundliches Material
- Härte: Shore „D“ ~75

Andere Qualitäten „rot – grau – weiß“ auf Anfrage

**Cutting Sticks
THE YELLOW CUTTING STICK – EX FASSCO**

- if Standard F-220
- if high alloyed F-3000
- if Carbide F-8000

for all knife-qualities

- Extended knife life
- High precision
- Increased cutting volume
- Excelent cutting quality
- Environmental friendly product
- Hardness: Shore “D” ~75

Other qualities “red – grey - white” on request

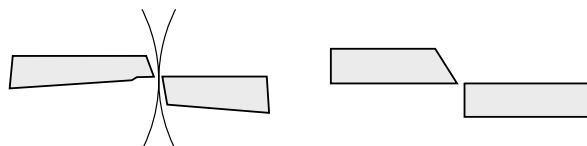

**Papierschnidmesser / Trimmermesser /
Querschnidmesser**

**FASSCO MULTI CUT
„F-4002 – F-4010“**

Pulvermetall (Vollstahl)

Veränderte Papierqualitäten erfordern zunehmend den Einsatz leistungsfähigerer Werkstoffe. Die pulvermetallurgisch hergestellten FASSCO MULTI CUT Qualitäten zeichnen sich durch wesentlich längere Standzeiten gegenüber konventionellen Stahlqualitäten aus.

**Paper Cutting Knives / Trimmer knives /
Sheeter knives**

**FASSCO MULTI CUT
“F-4002 – F-4010“**

Powder material (solid steel)

Different paper qualities are increasingly require more efficient materials. The pulvermetallurgic produced FASSCO MULTI CUT qualities distinguish a much higher endurance compared to conventional steel qualities.

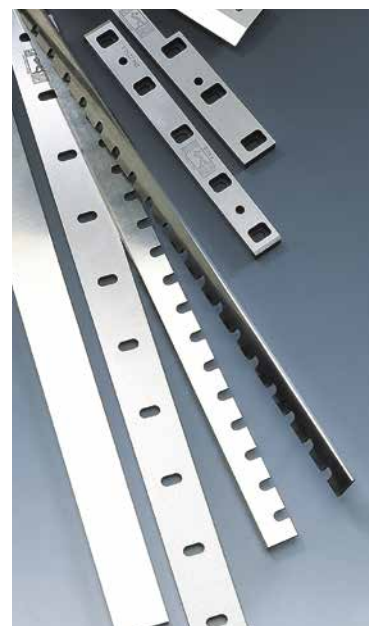

INHALTSVERZEICHNIS

INDEX

| Maschine / Machine | Seite / Page | Maschine / Machine | Seite / Page |
|----------------------------------|-------------------------------|--|--------------|
| A DAST MAXIMA | 9 | FOLDNAK (s. Nagel) | 131 |
| AM Graphics (s. Sheridan)..... | 171 - 182 | FURNIVAL | 41 |
| ARRIVABENE | **Zeichnung / ID erforderlich | FLIC(Flag)..... | 39 - 40 |
| ATLAS | 10 - 11 | F.T.P. (s. Comeca) | 27 |
| AUTOMABERG | 12 | G IDICO (s. Müller Langenfeld)..... | 89 - 92 |
| AYBAKAR | 12 | GOLDING | 42 |
| B AUMFOLDER..... | 13 | GOODHALE | 42 |
| BIELOMATIK | 224 - 234 | GRAFMASZ | 42 |
| BLUMER ATLAS | 14 | GRAFOPAT (s. Lazer) | 77 |
| BOGRAMA | 14 - 18 | GRAPHA (s. Müller-Martini) | 93 - 129 |
| BOURG | 18 - 19 | GRAPHOPRESS..... | 42 |
| BOWAY | 19 | GUARANI | 43 |
| BRACKETT | 19 | GUO WANG | 43 |
| BREHMER (Heidelberg) | 20 - 21 | H AMOSI-WEBER | 43 |
| C AMCO (s. Rosback) | 159 | HARRIS (s. Macey Harris)..... | 80 - 83 |
| CAMPEADOR | 21 | HEIDELBERG FINISHING..... | 44 - 48 |
| CASAGRANDE (s. Hunkeler) | 62 | HEROLD | 49 |
| CAUHÉ | 22 | HEUSER (s. Robust) | 159 |
| CEELEN | 22 | HÖRAUF | 50 - 52 |
| CEMPIRE (s. Dumor)..... | 35 | HOHNER | 52 - 56 |
| CHALLENGE | 22 - 25 | HORIZON | 57 - 61 |
| CHALLENGER (s. Jud)..... | 66 | HUNKELER | 62 |
| CHANDLER & PRICE | 26 | I DEAL (s. Krug&Priester) | 72 - 73 |
| COL-TEC | 26 | IMPERIAL | 62 |
| COMECA | 27 | ITOH | 63 - 65 |
| COMO | 28 - 29 | J ACKAL (s. Itoh)..... | 63 - 65 |
| CONSOLIDATED | 29 - 31 | JAGENBERG | ** |
| COOPER CCM (s. Feida)..... | 39 | JUD | 66 |
| CORTA | 31 | JURINE | 67 |
| D AEGU Saber..... | 32 | K ASFOLD | 67 |
| DAHLE | 32 | KATSUTA | 67 - 68 |
| DAYTON (s. Seybold) | 165 - 169 | KAYM | 68 |
| DEXTER | 32 | KÖRBER PAPER LINK..... | 234 - 242 |
| DGR Graphics..... | 33 | KOLBUS | 69 - 70 |
| DIAMOND ACE | 33 | KOMORI | 70 |
| DONGSHUL | 34 | KRAUSE - BIAGOSCH | 71 |
| DÖRRIES - PRINTAX | 34 | KRAVEC | 72 |
| DUMOR | 35 | KRUG & PRIESTER..... | 72 - 73 |
| DUPLO | 35 - 37 | KUGLER-WOMAKO | ** |
| E BA | 37 | KWANG LONG | 73 |
| EHINGER (s. Eba)..... | 37 | L ACONDA (Müller Langenfeld)..... | 89 - 92 |
| ETERNA (s. Herold)..... | 49 | LAWSON | 73 - 76 |
| EUROCUTTER (MZE) | 38 | LAZER | 77 |
| EUROPA (s. Purlux)..... | 156 - 157 | LHERMITE | 77 |
| F EIDA | 39 | LINOTYPE | 78 |
| FERAG | 40 - 41 | LITONG | 79 |
| FLAG (F.L.)..... | 39 - 40 | LMM (s. Mandelli)..... | 84 |

INHALTSVERZEICHNIS

INDEX

| Maschine / Machine | Seite / Page |
|---|--------------|
| M ACEY HARRIS | 80 - 83 |
| MANDELLI | 84 |
| MARTIN YALE | 84 |
| MATIGRAFICA (s. Splek)..... | 184 |
| MAXIMA (s. Adast)..... | 9 |
| MBM | 84 |
| MBO Digi Finisher (s. Hohner) | 52 - 56 |
| Mc CAIN | 85 - 89 |
| MICHAEL..... | 72 - 73, 84 |
| MKW (s. Müller Langenfeld)..... | 89 - 92 |
| Mohr (s. Polar)..... | 149 - 154 |
| MORGANA (s. Uchida)..... | 195 |
| MÜLLER LANGENFELD | 89 - 92 |
| MÜLLER MARTINI | 93 - 130 |
| MULTITEX (s. Mandelli) | 84 |
| MZE (s. Eurocutter)..... | 38 |
| N AGAI | 131 |
| NAGEL (Foldnak) | 131 |
| NATIONAL | 132 |
| NEBIOLO (s. Omac) | 133 |
| NISHIKAWA | 132 |
| O BSCURE | 132 |
| OMAC | 133 |
| OMEGA (s. Macey Harris)..... | 82 - 83 |
| OSAKO | 134 - 138 |
| P ACEMAKER (s. Lawson)..... | 73 - 76 |
| PALTEC (s. Short Run Engineering) | 183 |
| PAPYRUS (s. Purlux Europa) | 156 - 157 |
| PARAGON | 139 |
| PEERLESS GEM | 139 |
| PERFECTA | 140 - 146 |
| PIVANO | 147 - 148 |
| POLAR | 149 - 154 |
| POWERCUT (s. Kwang Long)..... | 73 |
| PRESTO | 154 |
| PRINTAX (s. Dörries)..... | 34 |
| PRINTECH | 155 |
| PRISM | 155 |
| PROTECK..... | 155 |
| PURLUX EUROPA | 156 - 157 |
| PURPLE MAGNA | 158 |
| Q UEEN (s. Itoh) | 63 - 65 |
| R ADOR | 158 |
| RAPIER (s. Corta)..... | 31 |
| RAPIER MATIC | 158 |
| RC SYSTEMS..... | 159 |
| REGENT (s. Lawson)..... | 73 - 76 |

| Maschine / Machine | Seite / Page |
|--------------------------------------|--------------|
| ROBOCUT (s. Itoh)..... | 63 - 65 |
| ROBUST (Heuser) | 159 |
| ROSBACK (s. Camco)..... | 159 |
| R.P.M. | 160 |
| S ABER (s. Seybold) | 165 - 169 |
| SAITO | 160 - 161 |
| SANKOH-SEIKI (s. Itoh)..... | 63 - 65 |
| SAROGLIA | 161 |
| SCHIMANEK | 162 - 163 |
| SCHNEIDER-ENGINEERING | 163 |
| SCHNEIDER-SENATOR | 164 - 165 |
| SEYBOLD | 165 - 169 |
| SHENJIAN | 170 |
| SHEN WEI DA | 170 |
| SHERIDAN | 171 - 182 |
| SHORT RUN ENGINEERING | 183 |
| SPERR & LECHNER | 184 |
| SPLEK (s. Sperr & Lechner) | 184 |
| SPRINT (s. Theisen & Bonitz) | 190 - 193 |
| STAHL | 185 - 187 |
| STAHL (s. Heidelberg)..... | 44 - 48 |
| STAHL (s. Hörauf) | 50 - 52 |
| SUNRAY (s. Duplo) | 35 - 37 |
| SWISS HYDROCUT (s. Casagrande) | 62 |
| T ECHMA | 188 - 189 |
| TEMPO (s. Herold)..... | 49 |
| THEISEN & BONITZ | 190 - 193 |
| TMF Schwennigen | 193 |
| TOROS | 193 |
| TOSINGRAF | 194 |
| TRÄNKLEIN | 194 |
| TRIMASS | 195 |
| TRIUMPH (s. Krug & Priester) | 72 - 73 |
| U CHIDA | 196 |
| UNIVERSAL (SchimaneK)..... | 162 - 163 |
| ÜSTGÜL | 196 |
| V ARIMEX | 196 |
| VPF (s. Hörauf) | 50 - 52 |
| VEGA (s. Guo Wang) | 43 |
| VICTORY-KIDDER..... | 196 - 197 |
| VULKAN (s. Müller Langenfeld)..... | 89 - 92 |
| W OHLBERG | 198 - 203 |
| Y ASHAMOTO | 204 |
| YOSHINO | 204 |

**FASSCO-Papierschnaidemesser
Sondermesser**

**FASSCO-Paper Cutting Knives
Special Knives**

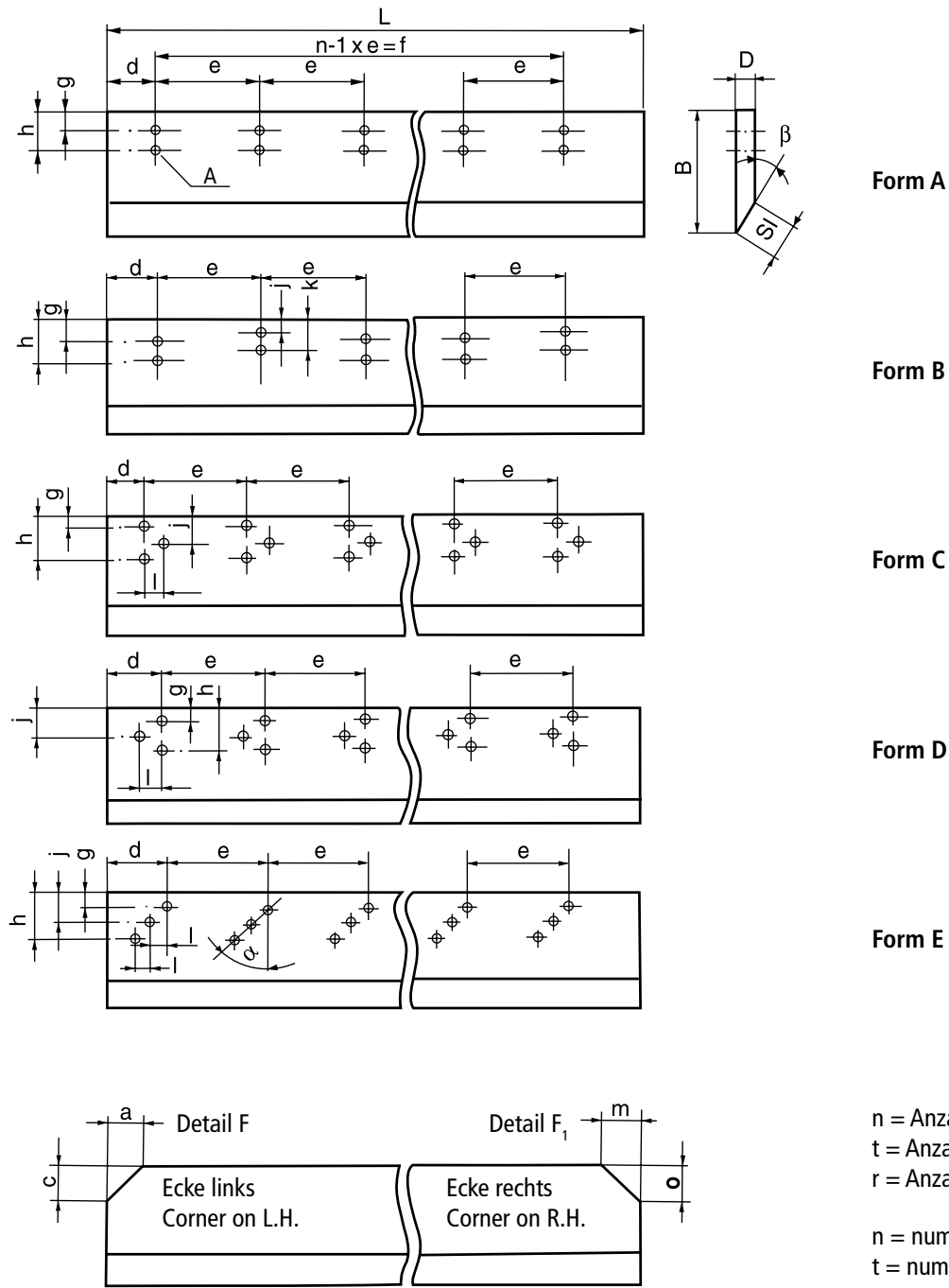

Erforderliche Angaben für Angebot und Fertigung.
Required details for quotation and production.

| Form | L | B | D | A | β | Sl | n | t | r | d | e | f |
|------|---|---|---|---|---------|----------|---|---|---|----------------|---|---|
| | | | | | | | | | | | | |
| | g | h | j | k | l | α | F | a | c | F ₁ | m | o |
| | | | | | | | | | | | | |

ADAST MAXIMA



| Maschinen-Typ Type/Type/Tipo | Abmessungen in mm Size/Dimension/Tamaño | Löcher/Holes Trous/Huecos | △ kg | FASSCO-Id. Qualität/Quality/Calid. | €/Stück Pce./Pce./Pza. |
|---------------------------------|--|------------------------------|---------|---------------------------------------|---------------------------|
| MJ 46 | 610 x 110 x 10 | 15/M10 | 4,65 | 024.03F220 | * |
| | | | | 024.03F3000 | * |
| MM/MS 58-S altes Modell | 720 x 110 x 10 | 12/M10 | 5,40 | 024.01F220 | * |
| | | | | 024.01F3000 | * |
| MM 58 Neues Modell | 720 x 110 x 10 | 18/M10 | 5,40 | 024.09F220 | * |
| | | | | 024.09F3000 | * |
| MM 62 (Wohlenberg) | 737 x 140 x 12 | 14/M12 | 8,55 | 004.27F220 | * |
| | | | | 004.27F3000 | * |
| MH 78 MH/MM 80-3 | 960 x 140 x 10 | 16/M12 | 9,30 | 024.02F220 | * |
| | | | | 024.02F3000 | * |
| MS 80 | 976 x 150 x 12 | 16/M12 | 12,30 | 024.16F220 | * |
| | | | | 024.16F3000 | * |
| MS 82 | 1000 x 140 x 10 | 18/M12 | 9,70 | 024.04F220 | * |
| | | | | 024.04F3000 | * |
| MS 92 RAPID | 1090 x 150 x 12 | 30/M12 | 13,50 | 024.07F220 | * |
| | | | | 024.07F3000 | * |
| MS 92 DF/PF | 1102 x 150 x 12 | 20/M12 | 13,60 | 024.13F220 | * |
| | | | | 024.13F3000 | * |
| MS 106 | 1250 x 150 x 10 | 33/M10 | 12,90 | 024.05F220 | * |
| | | | | 024.05F3000 | * |
| MS 107 P | 1250 x 150 x 12 | 45/M12 | 15,50 | 024.06F220 | * |
| | | | | 024.06F3000 | * |
| MS 115 | 1320 x 150 x 12 | 36/M12 | 16,40 | 024.08F220 | * |
| | | | | 024.08F3000 | * |



ARRIVABENE

| Maschinen-Typ Type/Type/Tipo | Abmessungen in mm Size/Dimension/Tamaño | Löcher/Holes Trous/Huecos | △ kg | FASSCO-Id. Qualität/Quality/Calid. | €/Stück Pce./Pce./Pza. |
|---------------------------------|--|------------------------------|---------|---------------------------------------|---------------------------|
| TC 52/53 | 670 x 80 x 8 | 7/M8 | 2,95 | 036.05F220 | * |
| | | | | 036.05F3000 | * |
| TC 72 EA | 835 x 80 x 6 | 6/M10 | 3,05 | 036.06F220 | * |
| | | | | 036.06F3000 | * |
| TC 73 H | 900 x 105 x 8 | 12/M10 | 5,23 | 036.01F220 | * |
| | | | | 036.01F3000 | * |
| TC 76 H | 954 x 105 x 8 | 14 | 5,53 | 036.02F220 | * |
| | | | | 036.02F3000 | * |
| TC 96 H | 1120 x 115 x 10 | 18 | 8,92 | 036.03F220 | * |
| | | | | 036.03F3000 | * |
| TC 116 H | 1340 x 120 x 12 | 22 | 13,40 | 036.04F220 | * |
| | | | | 036.04F3000 | * |

Für alle ARRIVABENE-Typen ist eine Zeichnung erforderlich.
For all ARRIVABENE-types a drawing is required.

* Preis auf Anfrage / Price on request

ATLAS



| Maschinen-Typ Type/Type/Tipo | Abmessungen in mm Size/Dimension/Tamaño | Löcher/Holes Trous/Huecos | ⚖ kg | FASSCO-Id. Qualität/Quality/Calid. | €/Stück Pce./Pce./Pza. |
|---------------------------------|--|------------------------------|---------|---------------------------------------|---------------------------|
| A 78 Z A 80 Y | 930 x 130 x 11,8 | 16/M12x1,75 | 9,90 | 001.01F220 | * |
| | | | | 001.01F3000 | * |
| A 80 Z | 950 x 135 x 11,8 | 16/M12x1,75 | 10,50 | 001.02F220 | * |
| | | | | 001.02F3000 | * |
| A 106 Z | 1210 x 135 x 11,8 | 22/M12x1,75 | 13,38 | 001.03F220 | * |
| | | | | 001.03F3000 | * |
| A 132 Z | 1500 x 140 x 13,8 | 28/M12x1,75 | 20,15 | 001.04F220 | * |
| | | | | 001.04F3000 | * |
| A 152 Z | 1700 x 140 x 13,8 | 32/M12x1,75 | 22,82 | 001.05F220 | * |
| | | | | 001.05F3000 | * |

ATLAS



| Maschinen-Typ Type/Type/Tipo | Abmessungen in mm Size/Dimension/Tamaño | Löcher/Holes Trous/Huecos | ⚖ kg | FASSCO-Id. Qualität/Quality/Calid. | €/Stück Pce./Pce./Pza. |
|---------------------------------|--|------------------------------|---------|---------------------------------------|---------------------------|
| A 28/39 | Vordermesser 500 x 130 x 11,8 | 8/M12x1,75 | 5,10 | 001.90/001F220 | * |
| | | | | 001.90/001F3000 | * |
| | Seitenmesser, links 410 x 130 x 11,8 | 6/M12x1,75 | 3,65 | 001.90/002F220 | * |
| | | | | 001.90/002F3000 | * |
| | Seitenmesser, rechts 410 x 130 x 11,8 | 6/M12x1,75 | 3,65 | 001.90/003F220 | * |
| | | | | 001.90/003F3000 | * |
| €/Satz/Set/Jeu/Juego | | | | | |
| A 28/39 | kompletter Satz complete set | = 3 Messer = 3 knives | 12,40 | 001.90/300F220 | * |
| | | | | 001.90/300F3000 | * |

| Maschinen-Typ Type/Type/Tipo | Abmessungen in mm Size/Dimension/Tamaño | Löcher/Holes Trous/Huecos | ⚖ kg | FASSCO-Id. Qualität/Quality/Calid. | €/Stück Pce./Pce./Pza. |
|---------------------------------|--|------------------------------|---------|---------------------------------------|---------------------------|
| A 25/35 X | Vordermesser 460 x 130 x 11,8 | 8/M12x1,75 | 4,70 | 001.91/001F220 | * |
| | | | | 001.91/001F3000 | * |
| | Seitenmesser, links 410 x 130 x 11,8 | 6/M12x1,75 | 3,55 | 001.91/002F220 | * |
| | | | | 001.91/002F3000 | * |
| | Seitenmesser, rechts 410 x 130 x 11,8 | 6/M12x1,75 | 3,55 | 001.91/003F220 | * |
| | | | | 001.91/003F3000 | * |
| €/Satz/Set/Jeu/Juego | | | | | |
| A 25/35 X | kompletter Satz complete set | = 3 Messer = 3 knives | 11,80 | 001.91/300F220 | * |
| | | | | 001.91/300F3000 | * |

Bei Auftragserteilung aller ATLAS-Typen bitte die Gewindeart prüfen und angeben.

When placing orders for all ATLAS-types please check and indicate kind of thread.

En cas d'une commande pour ATLAS-types priere d'examiner et indiquez mode de taraudage.

En caso de pedido de algún tipo ATLAS, rogamos comprueben e indiquen el tipo de rosca.



ATLAS

| Maschinen-Typ Type/Type/Tipo | Abmessungen in mm Size/Dimension/Tamaño | Löcher/Holes Trous/Huecos | ⚖ kg | FASSCO-Id. Qualität/Quality/Calid. | €/Stück Pce./Pce./Pza. |
|--|---|------------------------------|---------|---------------------------------------|---------------------------|
| A 25/35 X B 25/35 S Trennschnitt | Vordermesser 460 x 130 x 11,8 | 8/M12x1,75 | 4,70 | 001.91/001F220 | * |
| | | | | 001.91/001F3000 | * |
| | Seitenmesser, links (Trennschnittmesser) 410 x 145 x 11,8 | 6/M12x1,75 | 3,95 | 001.92/002F220 | * |
| | | | | 001.92/002F3000 | * |
| | Seitenmesser, rechts 410 x 130 x 11,8 | 6/M12x1,75 | 3,55 | 001.91/003F220 | * |
| | | | | 001.91/003F3000 | * |
| €/Satz/Set/Jeu/Juego | | | | | |
| A 25/35 X B 25/35 S Trennschnitt | kompletter Satz complete set | = 3 Messer = 3 knives | 12,20 | 001.92/300F220 | * |
| | | | | 001.92/300F3000 | * |

| Maschinen-Typ Type/Type/Tipo | Abmessungen in mm Size/Dimension/Tamaño | Löcher/Holes Trous/Huecos | ⚖ kg | FASSCO-Id. Qualität/Quality/Calid. | €/Stück Pce./Pce./Pza. |
|---------------------------------|--|------------------------------|---------|---------------------------------------|---------------------------|
| A 30/42 H | Vordermesser 530 x 122 x 12,8 | 8/M12 | 5,70 | 001.93/001F220 | * |
| | | | | 001.93/001F3000 | * |
| | Seitenmesser, links 458 x 150 x 12,8 | 6/M12 | 5,00 | 001.93/002F220 | * |
| | | | | 001.93/002F3000 | * |
| | Seitenmesser, rechts 458 x 150 x 12,8 | 6/M12 | 5,00 | 001.93/003F220 | * |
| | | | | 001.93/003F3000 | * |
| €/Satz/Set/Jeu/Juego | | | | | |
| A 30/42 H | kompletter Satz complete set | = 3 Messer = 3 knives | 15,70 | 001.93/300F220 | * |
| | | | | 001.93/300F3000 | * |

| Maschinen-Typ Type/Type/Tipo | Abmessungen in mm Size/Dimension/Tamaño | Löcher/Holes Trous/Huecos | ⚖ kg | FASSCO-Id. Qualität/Quality/Calid. | €/Stück Pce./Pce./Pza. |
|---------------------------------|--|------------------------------|---------|---------------------------------------|---------------------------|
| A 30/42 VH | Vordermesser 560 x 122 x 12,8 | 8/M12 | 6,00 | 001.94/001F220 | * |
| | | | | 001.94/001F3000 | * |
| | Seitenmesser, links 453 x 150 x 12,8 | 6/M12 | 4,95 | 001.94/002F220 | * |
| | | | | 001.94/002F3000 | * |
| | Seitenmesser, rechts 453 x 150 x 12,8 | 6/M12 | 4,95 | 001.94/003F220 | * |
| | | | | 001.94/003F3000 | * |
| €/Satz/Set/Jeu/Juego | | | | | |
| A 30/42 VH | kompletter Satz complete set | = 3 Messer = 3 knives | 15,90 | 001.94/300F220 | * |
| | | | | 001.94/300F3000 | * |

Bei Auftragserteilung aller ATLAS-Typen bitte die Gewindeart prüfen und angeben.
 When placing orders for all ATLAS-types please check and indicate kind of thread.
 En cas d'une commande pour ATLAS-types priere d'examiner et indiquez mode de taraudage.
 En caso de pedido de algún tipo ATLAS, rogamos comprueben e indiquen el tipo de rosca.

SCS AUTOMABERG

| Maschinen-Typ Type/Type/Tipo | Abmessungen in mm Size/Dimension/Tamaño | Löcher/Holes Trous/Huecos | ⚖️ kg | FASSCO-Id. Qualität/Quality/Calid. | €/Stück Pce./Pce./Pza. |
|---------------------------------|--|------------------------------|----------|---------------------------------------|---------------------------|
| Easy Trim | 510 x 157/153 x 15 (3190) | 12 Langlö. 2/M10 | 8,90 | 142.02F3000 | * |
| Easy Fly | 700 x 140 x 13 (100-10-010) | 16/M10 4/M6 | 8,80 | 142.01F3000 | * |

| Maschinen-Typ Type/Type/Tipo | Abmessungen in mm Size/Dimension/Tamaño | Löcher/Holes Trous/Huecos | ⚖️ kg | FASSCO-Id. Qualität/Quality/Calid. | €/Stück Pce./Pce./Pza. |
|--|--|------------------------------|----------|---------------------------------------|---------------------------|
| TRI SPLIT Stanzen V-Fase Punch cut V Shape | Obermesser 232 x 73/68 x 6 | 5 Langlöcher | 0,70 | 142.60/006F236 | * |
| | Obermesser 232 x 73/68 x 8 | 5 Langlöcher | 0,95 | 142.60/008F236 | * |
| | Untermesser, links 250 x 10/9,5 x 9 | 6/M4 | 0,18 | 142.90/123F236 | * |
| | Untermesser, rechts 250 x 10/9,5 x 9 | 6/M4 | 0,18 | 142.90/123F236 | * |

| Maschinen-Typ Type/Type/Tipo | Abmessungen in mm Size/Dimension/Tamaño | Löcher/Holes Trous/Huecos | ⚖️ kg | FASSCO-Id. Qualität/Quality/Calid. | €/Stück Pce./Pce./Pza. |
|--|--|------------------------------|----------|---------------------------------------|---------------------------|
| TRI SPLIT Stanzen V-Fase mit Luft Punch cut V-shape with air | Obermesser 232 x 73/68 x 6 | 5 Langlöcher 5/M5-20/Ø3 | 0,68 | 142.90/206F236 | * |
| | Obermesser 232 x 73/68 x 8 | 5 Langlöcher 5/M5-20/Ø3 | 0,93 | 142.90/208F236 | * |
| | Untermesser, links 250 x 10/9,5 x 9 | 6/M4 | 0,18 | 142.90/123F236 | * |
| | Untermesser, rechts 250 x 10/9,5 x 9 | 6/M4 | 0,18 | 142.90/123F236 | * |



AYBAKAR

| Maschinen-Typ Type/Type/Tipo | Abmessungen in mm Size/Dimension/Tamaño | Löcher/Holes Trous/Huecos | ⚖️ kg | FASSCO-Id. Qualität/Quality/Calid. | €/Stück Pce./Pce./Pza. |
|---------------------------------|--|------------------------------|----------|---------------------------------------|---------------------------|
| | 720 x 100 x 8 | | 3,95 | 100.01F220 | * |
| | | | | 100.01F3000 | * |
| 72 | 920 x 90 x 9 | | 5,15 | 100.02F220 | * |
| | | | | 100.02F3000 | * |
| 85 | 1020 x 140 x 10 | | 9,85 | 100.03F220 | * |
| | | | | 100.03F3000 | * |
| | 1400 x 140 x 12 | | 16,30 | 100.04F220 | * |
| | | | | 100.04F3000 | * |

Für alle AYBAKAR-Typen ist eine Zeichnung erforderlich.
For all AYBAKAR-types a drawing is required.



BAUMFOLDER (HEIDELBERG)

| Maschinen-Typ Type/Type/Tipo | Abmessungen in mm Size/Dimension/Tamaño | Löcher/Holes Trous/Huecos | ⚖️ kg | FASSCO-Id. Qualität/Quality/Calid. | €/Stück Pce./Pce./Pza. |
|------------------------------------|---|------------------------------|----------|---------------------------------------|---------------------------|
| PM 58 (=POLAR 58) | 715 x 95 x 9,7 28.15" x 3.740" x .382" 260-538-00-11 260-538-01-00/248356(F2) 260-538-02-00/248875(F3) | 12/M10 | 4,50 | 007.30F220 | * |
| | | | | 007.30F3000 | * |
| 30-1/2" (=Challenge 30.1/2") | 882,65 x 101,6 x 9,50 34.3/4" x 4" x .374" 2238-2 | 12 3/8"-16 | 5,90 | 050.10F220 | * |
| | | | | 050.10F3000 | * |
| PM 80/BC 80 bis/up to 10.96 | 960 x 107 x 9,68 37.795" x 4.213" x .381" 265-007-00-11 265-007-01-00 265-007-02-00(F2) 265-007-03-00(F3) | 12/M10 | 6,88 | 074.02F220 | * |
| | | | | 074.02F3000 | * |
| BC 80 ab/from 11.96 | 950 x 107 x 9,68 37.42" x 4.213" x .381" 265-007-00-11 265-007-01-00 265-007-02-00 (F2) 265-007-03-00 (F3) | 18/M10 | 6,80 | 074.04F220 | * |
| | | | | 074.04F3000 | * |
| MPU-42" | 1346 x 127 x 12,6 53" x 5" x .496" 2BA4016 | 27 1/2"-13 | 14,90 | 048.02F220 | * |
| | | | | 048.02F3000 | * |
| MPU-47" | 1498,6 x 127 x 12,6 59" x 5" x .496" 2BB4001 | 30 1/2"-13 | 16,60 | 048.19F220 | * |
| | | | | 048.19F3000 | * |
| MPU-52" | 1625,6 x 127 x 12,6 64" x 5" x .496" 2BC4002 | 33 1/2"-13 | 18,00 | 048.07F220 | * |
| | | | | 048.07F3000 | * |
| MPU-60" | 1854,2 x 127 x 12,6 73" x 5" x .496" 2BE5046 | 36 1/2"-13 | 20,60 | 048.09F220 | * |
| | | | | 048.09F3000 | * |

| Maschinen-Typ Type/Type/Tipo | Abmessungen in mm Size/Dimension/Tamaño | Löcher/Holes Trous/Huecos | ⚖️ kg | FASSCO-Id. Qualität/Quality/Calid. | €/Stück Pce./Pce./Pza. |
|---|--|-------------------------------|----------|---------------------------------------|---------------------------|
| Stanzen V-Fase Punch Cut V-Shape OMEGA METRIC | Obermesser .250" 275-812-00-11 361,95 x 95,25/76,2 x 6,35 (14.250x3.750x.250") | 5 Langlöcher 2/M12 4/M4 | 1,25 | 074.62/006F236 | * |
| | Obermesser .375" 275-813-00-11 361,95 x 95,25/76,2 x 9,52 (14.250x3.750x.375") | 5 Langlöcher 2/M12 4/M5 | 1,81 | 074.62/009F236 | * |
| | Obermesser .500" 275-814-00-11 361,95 x 95,25/76,2 x 12,70 (14.250x3.750x.500") | 5 Langlöcher 2/M12 4/M5 | 2,35 | 074.62/012F236 | * |

BLUMER ATLAS



| Maschinen-Typ Type/Type/Tipo | Abmessungen in mm Size/Dimension/Tamaño | Löcher/Holes Trous/Huecos | kg | FASSCO-Id. Qualität/Quality/Calid. | €/Stück Pce./Pce./Pza. |
|---------------------------------|--|------------------------------|------|---------------------------------------|---------------------------|
| 1110 (kurz) | 340 x 187 x 10 (311065) | 10/M6 1/M8-21tief | 4,45 | 106.04F8000 | * |
| 110/120 | 475/355 x 130 x 10 (200262) | 2/55 Ø 2/M8 | 3,80 | 106.01F3000 | * |
| | | | | 106.01F8000 | * |
| 1110 | 545/445 x 170 x 10 (307422) | 2/55 Ø 2/M8 | 6,05 | 106.02F8000 | * |
| 400 | 670 x 150 x 14 (205652) | 7/M8 | 9,70 | 106.03F8000 | * |

* Preise F8000 HM auf Anfrage
* prices F8000 TCT on request

BOGRAMA



| Maschinen-Typ Type/Type/Tipo | Abmessungen in mm Size/Dimension/Tamaño | Löcher/Holes Trous/Huecos | kg | FASSCO-Id. Qualität/Quality/Calid. | €/Stück Pce./Pce./Pza. |
|---|--|------------------------------|------|---------------------------------------|---------------------------|
| BS 450/750 MULTI 450D BSM 750/220 | Obermesser (Front) 480 x 75/60/56 x 12 | 8 Langlöcher 2/M8, 5/M5 | 1,90 | 131.90/001F236 | 355,00 |
| | Untermesser (Front) 480 x 22,5 x 8,2 | 8 zyl.vers. Langlöcher | 0,55 | 131.90/101F236 | 224,00 |

| Maschinen-Typ Type/Type/Tipo | Abmessungen in mm Size/Dimension/Tamaño | Löcher/Holes Trous/Huecos | kg | FASSCO-Id. Qualität/Quality/Calid. | €/Stück Pce./Pce./Pza. |
|---|---|------------------------------|------|---------------------------------------|---------------------------|
| BS 450/750 MULTI 450D BSM 750/220 | Seitenmesser, oben links Trennschnittmesser links 224 x 60/56 x 8 | 5 Langlöcher | 0,65 | 131.90/002F236 | 120,00 |
| | Seitenmesser, oben rechts Trennschnittmesser rechts 224 x 60/56 x 8 | 5 Langlöcher | 0,65 | 131.90/003F236 | 120,00 |
| | Seitenmesser, unten links Standard 226 x 15 x 8,2 | 5 zyl.vers. Langlöcher | 0,15 | 131.90/123F236 | 113,00 |
| | Seitenmesser, unten rechts Standard 226 x 15 x 8,2 | 5 zyl.vers. Langlöcher | 0,15 | 131.90/123F236 | 113,00 |
| | Seitenmesser, unten links Schmal 226 x 10,2 x 8,2 | 5 zyl.vers. Löcher | 0,10 | 131.90/145F236 | 102,00 |
| | Seitenmesser, unten rechts Schmal 226 x 10,2 x 8,2 | 5 zyl.vers. Löcher | 0,10 | 131.90/145F236 | 102,00 |



BOGRAMA

| Maschinen-Typ Type/Type/Tipo | Abmessungen in mm Size/Dimension/Tamaño | Löcher/Holes Trous/Huecos | kg | FASSCO-Id. Qualität/Quality/Calid. | €/Stück Pce./Pce./Pza. |
|--|--|------------------------------|------|---------------------------------------|---------------------------|
| BS 450/750 MULTI 450D BSM 750/220 Sondermesser special knife | Seitenmesser, unten links 226 x 15 x 8,2 Fräsung links | 5 zyl.vers. Langlöcher | 0,15 | 131.90/102F236 | 126,00 |
| | Seitenmesser, unten rechts 226 x 15 x 8,2 Fräsung rechts | 5 zyl.vers. Langlöcher | 0,15 | 131.90/103F236 | 126,00 |

| Maschinen-Typ Type/Type/Tipo | Abmessungen in mm Size/Dimension/Tamaño | Löcher/Holes Trous/Huecos | kg | FASSCO-Id. Qualität/Quality/Calid. | €/Stück Pce./Pce./Pza. |
|---------------------------------|--|------------------------------|------|---------------------------------------|---------------------------|
| BS 750/320 | Obermesser, links 324 x 60/56 x 8 | 6 Langlöcher | 0,95 | 131.91/002F236 | 180,00 |
| | Obermesser, rechts 324 x 60/56 x 8 | 6 Langlöcher | 0,95 | 131.91/003F236 | 180,00 |
| | Untermesser links 328 x 19,2 x 8,2 | 6 zyl.vers. Langlöcher | 0,30 | 131.91/123F236 | 171,00 |
| | Untermesser rechts 328 x 19,2 x 8,2 | 6 zyl.vers. Langlöcher | 0,30 | 131.91/123F236 | 171,00 |

| Maschinen-Typ Type/Type/Tipo | Abmessungen in mm Size/Dimension/Tamaño | Löcher/Holes Trous/Huecos | kg | FASSCO-Id. Qualität/Quality/Calid. | €/Stück Pce./Pce./Pza. |
|---------------------------------|--|------------------------------|------|---------------------------------------|---------------------------|
| BS 750 L=390 | Obermesser (Front) 390 x 63/56 x 12 | 6 Langlöcher 2/M8, 4/M5 | 1,80 | 131.92/001F236 | 360,00 |
| | Untermesser (Front) 390 x 15 x 20 | 6 zyl.vers. Langlöcher | 0,85 | 131.92/101F236 | 278,00 |

| Maschinen-Typ Type/Type/Tipo | Abmessungen in mm Size/Dimension/Tamaño | Löcher/Holes Trous/Huecos | kg | FASSCO-Id. Qualität/Quality/Calid. | €/Stück Pce./Pce./Pza. |
|---|---|------------------------------|------|---------------------------------------|---------------------------|
| BS 450/750 MULTI 450D BSM 750/220 SERVO Stanzen U-Fase Punch cut U-shape | Obermesser 224 x 60/56 x 4,2 | 5 Langlöcher | 0,40 | 131.60/004F236 | 189,00 |
| | Obermesser 224 x 60/56 x 5,2 | 5 Langlöcher | 0,50 | 131.60/005F236 | 189,00 |
| | Obermesser 224 x 60/56 x 6,2 | 5 Langlöcher | 0,55 | 131.60/006F236 | 189,00 |
| | Obermesser 224 x 60/56 x 8,2 | 5 Langlöcher | 0,70 | 131.60/008F236 | 214,00 |
| | Obermesser 224 x 60/56 x 10,2 | 5 Langlöcher | 0,90 | 131.60/010F236 | 247,00 |
| | Obermesser 224 x 60/56 x 12,2 | 5 Langlöcher | 1,05 | 131.60/012F236 | 268,00 |
| | Untermesser, links Standard 226 x 15 x 8,2 | 5 zyl.vers. Langlöcher | 0,15 | 131.90/123F236 | 113,00 |
| | Untermesser, rechts Standard 226 x 15 x 8,2 | 5 zyl.vers. Langlöcher | 0,15 | 131.90/123F236 | 113,00 |
| | Untermesser, links Schmal 226 x 10,2 x 8,2 | 5 zyl.vers. Löcher | 0,10 | 131.90/145F236 | 102,00 |
| | Untermesser, rechts Schmal 226 x 10,2 x 8,2 | 5 zyl.vers. Löcher | 0,10 | 131.90/145F236 | 102,00 |

BOGRAMA



| Maschinen-Typ Type/Type/Tipo | Abmessungen in mm Size/Dimension/Tamaño | Löcher/Holes Trous/Huecos | △ kg | FASSCO-Id. Qualität/Quality/Calid. | €/Stück Pce./Pce./Pza. |
|---|---|--------------------------------|----------------|---------------------------------------|---------------------------|
| BS 450/750 MULTI 450D BSM 750/220 SERVO Stanzen U-Fase mit Luft Punch cut U-shape with Air | Obermesser 224 x 60/56 x 4,2 | 5 Langlöcher 6 Ta. - 6/Ø3,0 | 0,40 | 131.60/204F236 | 240,00 |
| | Obermesser 224 x 60/56 x 5,2 | 5 Langlöcher 6 Ta. - 6/Ø3,0 | 0,45 | 131.60/205F236 | 240,00 |
| | Obermesser 224 x 60/56 x 6,2 | 5 Langlöcher 6 Ta. - 6/Ø3,0 | 0,50 | 131.60/206F236 | 240,00 |
| | Obermesser 224 x 60/56 x 8,2 | 5 Langlöcher 6 Ta. - 6/Ø3,0 | 0,65 | 131.60/208F236 | 259,00 |
| | Obermesser 224 x 60/56 x 10,2 | 5 Langlöcher 6 Ta. - 6/Ø3,0 | 0,80 | 131.60/210F236 | 267,00 |
| | Obermesser 224 x 60/56 x 12,2 | 5 Langlöcher 6 Ta. - 6/Ø3,0 | 0,95 | 131.60/212F236 | 292,00 |
| | Untermesser, links Standard 226 x 15 x 8,2 | 5 zyl.vers. Langlöcher | 0,15 | 131.90/123F236 | 113,00 |
| | Untermesser, rechts Standard 226 x 15 x 8,2 | 5 zyl.vers. Langlöcher | 0,15 | 131.90/123F236 | 113,00 |
| | Untermesser, links Schmal 226 x 10,2 x 8,2 | 5 zyl.vers. Löcher | 0,10 | 131.90/145F236 | 102,00 |
| Untermesser, rechts Schmal 226 x 10,2 x 8,2 | 5 zyl.vers. Löcher | 0,10 | 131.90/145F236 | 102,00 | |

| Maschinen-Typ Type/Type/Tipo | Abmessungen in mm Size/Dimension/Tamaño | Löcher/Holes Trous/Huecos | △ kg | FASSCO-Id. Qualität/Quality/Calid. | €/Stück Pce./Pce./Pza. |
|---|---|-------------------------------|---------|---------------------------------------|---------------------------|
| BS 450/750 MULTI 450D BSM 750/220 SERVO Stanzen U-Fase mit Stiftlö. Punch cut U-shape with spring pin holes | Obermesser 224 x 60/56 x 8,2 | 5 Langlöcher 8/M6-Ø5,2/4,2 | 0,65 | 131.60/408F236 | 259,00 |
| | Obermesser 224 x 60/56 x 10,2 | 5 Langlöcher 8/M6-Ø5,2/4,2 | 0,80 | 131.60/410F236 | 267,00 |
| | Obermesser 224 x 60/56 x 12,2 | 5 Langlöcher 8/M6-Ø5,2/4,2 | 0,95 | 131.60/412F236 | 292,00 |
| | Untermesser, links Standard 226 x 15 x 8,2 | 5 zyl.vers. Langlöcher | 0,15 | 131.90/123F236 | 113,00 |
| | Untermesser, rechts Standard 226 x 15 x 8,2 | 5 zyl.vers. Langlöcher | 0,15 | 131.90/123F236 | 113,00 |
| | Untermesser, links Schmal 226 x 10,2 x 8,2 | 5 zyl.vers. Löcher | 0,10 | 131.90/145F236 | 102,00 |
| | Untermesser, rechts Schmal 226 x 10,2 x 8,2 | 5 zyl.vers. Löcher | 0,10 | 131.90/145F236 | 102,00 |



BOGRAMA

| Maschinen-Typ Type/Type/Tipo | Abmessungen in mm Size/Dimension/Tamaño | Löcher/Holes Trous/Huecos | △ kg | FASSCO-Id. Qualität/Quality/Calid. | €/Stück Pce./Pce./Pza. |
|--|---|---|---------|---------------------------------------|---------------------------|
| BS 450/750 MULTI 450D BSM 750/220 SERVO Stanzen U-Fase mit Stiftlö. u. Luftlö. Punch cut U-shape with spring pin holes with air | Obermesser 224 x 60/56 x 8,2 | 5 Langlöcher 6/M6-Ø5,2/4,2 6 Ta. - 6/Ø3,0 | 0,65 | 131.60/608F236 | 304,00 |
| | Obermesser 224 x 60/56 x 10,2 | 5 Langlöcher 6/M6-Ø5,2/4,2 6 Ta. - 6/Ø3,0 | 0,80 | 131.60/610F236 | 337,00 |
| | Obermesser 224 x 60/56 x 12,2 | 5 Langlöcher 6/M6-Ø5,2/4,2 6 Ta. - 6/Ø3,0 | 0,95 | 131.60/612F236 | 358,00 |
| | Untermesser links Standard 226 x 15 x 8,2 | 5 zyl.vers. Langlöcher | 0,15 | 131.90/123F236 | 113,00 |
| | Untermesser, rechts Standard 226 x 15 x 8,2 | 5 zyl.vers. Langlöcher | 0,15 | 131.90/123F236 | 113,00 |
| | Untermesser, links Schmal 226 x 10,2 x 8,2 | 5 zyl.vers. Löcher | 0,10 | 131.90/145F236 | 102,00 |
| | Untermesser, rechts Schmal 226 x 10,2 x 8,2 | 5 zyl.vers. Löcher | 0,10 | 131.90/145F236 | 102,00 |

| Maschinen-Typ Type/Type/Tipo | Abmessungen in mm Size/Dimension/Tamaño | Löcher/Holes Trous/Huecos | △ kg | FASSCO-Id. Qualität/Quality/Calid. | €/Stück Pce./Pce./Pza. |
|--|--|--------------------------------|---------|---------------------------------------|---------------------------|
| BS 450/750 MULTI 450D BSM 750/320 SERVO Stanzen U-Fase mit Luft Punch cut | Obermesser 324 x 60/56 x 5,2 | 6 Langlöcher 4 Ta. - 6/Ø3,0 | 0,70 | 131.62/205F236 | 292,00 |
| | Obermesser 324 x 60/56 x 6,2 | 6 Langlöcher 4 Ta. - 6/Ø3,0 | 0,80 | 131.62/206F236 | 292,00 |
| | Obermesser 324 x 60/56 x 8,2 | 6 Langlöcher 4 Ta. - 6/Ø3,0 | 1,00 | 131.62/208F236 | 310,00 |
| | Obermesser 324 x 60/56 x 10,2 | 6 Langlöcher 4 Ta. - 6/Ø3,0 | 1,30 | 131.62/210F236 | 332,00 |
| | Obermesser 324 x 60/56 x 12,2 | 6 Langlöcher 4 Ta. - 6/Ø3,0 | 1,60 | 131.62/212F236 | 360,00 |
| | Untermesser, links 328 x 19,2 x 8,2 | 6 zyl.vers. Langlöcher | 0,30 | 131.91/123F236 | 171,00 |
| | Untermesser, rechts 328 x 19,2 x 8,2 | 6 zyl.vers. Langlöcher | 0,30 | 131.91/123F236 | 171,00 |

BOGRAMA



| Maschinen-Typ Type/Type/Tipo | Abmessungen in mm Size/Dimension/Tamaño | Löcher/Holes Trous/Huecos | △ kg | FASSCO-Id. Qualität/Quality/Calid. | €/Stück Pce./Pce./Pza. |
|---|--|---|---------|---------------------------------------|---------------------------|
| BS 450/750 MULTI 450D BSM 750/320 SERVO Stanz U-Fase mit Stiftlö. u. Luftlö. Punch cut U-shape with spring pin holes with air | Obermesser 324 x 60/56 x 8,2 | 6 Langlöcher 7/M6-Ø5,2/4,2 4 Ta. - 6/Ø3,0 | 1,00 | 131.62/608F236 | 331,00 |
| | Obermesser 324 x 60/56 x 10,2 | 6 Langlöcher 7/M6-Ø5,2/4,2 4 Ta. - 6/Ø3,0 | 1,30 | 131.62/610F236 | 342,00 |
| | Obermesser 324 x 60/56 x 12,2 | 6 Langlöcher 7/M6-Ø5,2/4,2 4 Ta. - 6/Ø3,0 | 1,60 | 131.62/612F236 | 358,00 |
| | Untermesser, links 328 x 19,2 x 8,2 | 6 zyl.vers. Langlöcher | 0,30 | 131.91/123F236 | 171,00 |
| | Untermesser, links 328 x 19,2 x 8,2 | 6 zyl.vers. Langlöcher | 0,30 | 131.91/123F236 | 171,00 |

| Maschinen-Typ Type/Type/Tipo | Abmessungen in mm Size/Dimension/Tamaño | Löcher/Holes Trous/Huecos | △ kg | FASSCO-Id. Qualität/Quality/Calid. | €/Stück Pce./Pce./Pza. |
|---------------------------------|---|------------------------------|---------|---------------------------------------|---------------------------|
| BS kurz BS short | Seitenmesser, oben links Trennschnittmesser links 124 x 60/56 x 8,2 | 3 Langlöcher | 0,35 | 131.73/002F236 | 121,00 |
| | Seitenmesser, oben rechts Trennschnittmesser rechts 124 x 60/56 x 8,2 | 3 Langlöcher | 0,35 | 131.73/003F236 | 121,00 |
| | Seitenmesser, unten links Standard 226 x 15 x 8,2 | 5 zyl.vers. Langlöcher | 0,15 | 131.90/123F236 | 113,00 |
| | Seitenmesser, unten rechts Standard 226 x 15 x 8,2 | 5 zyl.vers. Langlöcher | 0,15 | 131.90/123F236 | 113,00 |

BOURG

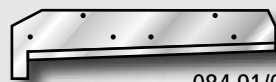

084.91/011



084.91/001

| Maschinen-Typ Type/Type/Tipo | Abmessungen in mm Size/Dimension/Tamaño | Löcher/Holes Trous/Huecos | △ kg | FASSCO-Id. Qualität/Quality/Calid. | €/Stück Pce./Pce./Pza. |
|--|---|------------------------------|---------|---------------------------------------|---------------------------|
| TR-t Frontschneider Front cutter | Obermesser, Nase rechts 380,5 x 90/60/47 x 12 (9.212.375.C TR) | 6/8,7 Ø | 1,55 | 084.91/001F236 | 265,00 |
| | Obermesser, Nase links 380,5 x 90/60/47 x 12 (9.214.280.C TR.X) | 6/8,7 Ø | 1,55 | 084.91/011F236 | 265,00 |
| | Untermesser 384 x 40 x 15 (9.212.376.B) | 5 zyl. vers.Löcher | 1,65 | 084.91/101F236 | 182,00 |

BOURG

| Maschinen-Typ Type/Type/Tipo | Abmessungen in mm Size/Dimension/Tamaño | Löcher/Holes Trous/Huecos | ⚖️ kg | FASSCO-Id. Qualität/Quality/Calid. | €/Stück Pce./Pce./Pza. |
|---------------------------------|--|------------------------------|----------|---------------------------------------|---------------------------|
| B.C. | Obermesser 365 x 90/60/48 x 12 | 6/8,5 Ø | 1,53 | 084.90/001F236 | 265,00 |
| | Untermesser 365 x 40 x 15 | 5 zyl. vers.Löcher | 1,57 | 084.90/101F236 | 182,00 |

(Einmesser Dreischneider Challenge)

| Maschinen-Typ Type/Type/Tipo | Abmessungen in mm Size/Dimension/Tamaño | Löcher/Holes Trous/Huecos | ⚖️ kg | FASSCO-Id. Qualität/Quality/Calid. | €/Stück Pce./Pce./Pza. |
|---|---|------------------------------|----------|---------------------------------------|---------------------------|
| Dreischneider Three knife Tr. CMT-330 | 368,3 x 69,85 x 9,52 14.1/2" x 2.75" x .375" | 6 3/8"-16 2 =ø3,6mm | 1,50 | 050.43F3000 | 142,00 |

| Maschinen-Typ Type/Type/Tipo | Abmessungen in mm Size/Dimension/Tamaño | Löcher/Holes Trous/Huecos | ⚖️ kg | FASSCO-Id. Qualität/Quality/Calid. | €/Stück Pce./Pce./Pza. |
|---------------------------------|---|------------------------------|----------|---------------------------------------|---------------------------|
| TR.BME | Obermesser 425 x 73 x 8 (9.232.899) | 7 LL 2/M6 | 1,75 | 084.92/001F236 | 348,00 |
| | Untermesser 435 x 18 x 11 | 4/M6 | 0,75 | 084.92/101F236 | 210,00 |
| | Untermesser 458 x 19 x 11 (9.232.898) | 7/M6 | 0,80 | 084.92/111F236 | 210,00 |

BOWAY

| Maschinen-Typ Type/Type/Tipo | Abmessungen in mm Size/Dimension/Tamaño | Löcher/Holes Trous/Huecos | ⚖️ kg | FASSCO-Id. Qualität/Quality/Calid. | €/Stück Pce./Pce./Pza. |
|---|--|------------------------------|----------|---------------------------------------|---------------------------|
| AR520S/T/Z CB 450/ GR480 BW 450/480 | 600 x 80 x 8 | 14/M8 | 2,65 | 161.01F220 | * |
| | | | | 161.01F3000 | * |



BRACKETT

| Maschinen-Typ Type/Type/Tipo | Abmessungen in mm Size/Dimension/Tamaño | Löcher/Holes Trous/Huecos | ⚖️ kg | FASSCO-Id. Qualität/Quality/Calid. | €/Stück Pce./Pce./Pza. |
|---------------------------------|---|------------------------------|----------|---------------------------------------|---------------------------|
| Tail Trimmer #824 | 282,58 x 57,15 x 6,35 11.1/8" x 2.1/4" x .250" | 4 1/4"-20 1 #10-24 | 0,65 | 049.06F236 | * |
| Pad Line K. | 381 x 31,8 x 3,175/1,32 15" x 1.250" x .125"/.052" | | 0,20 | 049.07F236 | * |
| Modell A SK-3048 | 520,7 x 127 x 12,65 20.1/2" x 5" x .498" | 6 1/2"-13 1 7/16"-20 | 5,80 | 049.04F220 | * |
| | | | | 049.04F3000 | * |
| Modell B-BT 145 | 628,65 x 127 x 12,65 24.3/4" x 5" x .498" | 8 1/2"-13 | 7,00 | 049.02F220 | * |
| | | | | 049.02F3000 | * |
| Modell A M-5070B | 812,8 x 127 x 12,65 32" x 5" x .498" | 12 1/2"-13 1 7/16"-20 | 9,00 | 049.03F220 | * |
| | | | | 049.03F3000 | * |

BREHMER/BREHMER-STAHL/HEIDELBERG



| Maschinen-Typ Type/Type/Tipo | Abmessungen in mm Size/Dimension/Tamaño | Löcher/Holes Trous/Huecos | ⚖️ kg | FASSCO-Id. Qualität/Quality/Calid. | €/Stück Pce./Pce./Pza. |
|--|---|------------------------------|----------------|---------------------------------------|---------------------------|
| 771/772 735/742 745/750 ST200 S1000C/T | Vordermesser, oben Figur 2611(611) 425.00–0173.1/01 506 x 100 x 8 | 12/M10 | 2,70 | 028.90/001F236 | * |
| | | | | 028.90/001F3000 | * |
| | Seitenmesser, oben links Figur 2618(618) 425.00–0230.1/01 330 x 100 x 8 | 8/M10 | 1,75 | 028.90/023F236 | * |
| | | | | 028.90/023F3000 | * |
| | Seitenmesser, oben rechts Figur 2618(618) 425.00–0230.1/01 330 x 100 x 8 | 8/M10 | 1,75 | 028.90/023F236 | * |
| | | | | 028.90/023F3000 | * |
| | Vordermesser, unten Figur 2607(607) 425.00–4027.1/1e 506 x 60 x 10 | 6 vers. Lö. 3/M10 | 2,20 | 028.90/101F236 | * |
| Seitenmesser, unten links Figur 2616(616) 425.00–4036.1/1e 330 x 60 x 10 | 4 vers. Lö. 2/M10 | 1,45 | 028.90/123F236 | * | |
| Seitenmesser, unten rechts Figur 2616(616) 425.00–4036.1/1e 330 x 60 x 10 | 4 vers. Lö. 2/M10 | 1,45 | 028.90/123F236 | * | |
| €/Satz/Set/Jeu/Juego | | | | | |
| 771/772 735/742 745/750 ST200 S1000C/T | Satz Obermesser Set Upper knives | = 3 Messer = 3 knives | 6,20 | 028.90/300F236 | * |
| | Satz Obermesser Set Upper knives | = 3 Messer = 3 knives | 6,20 | 028.90/300F3000 | * |
| | Satz Untermesser Set Bottom knives | = 3 Messer = 3 knives | 5,10 | 028.90/303F236 | * |

BREHMER/BREHMER-STAHL/HEIDELBERG



| Maschinen-Typ Type/Type/Tipo | Abmessungen in mm Size/Dimension/Tamaño | Löcher/Holes Trous/Huecos | ⚖️ kg | FASSCO-Id. Qualität/Quality/Calid. | €/Stück Pce./Pce./Pza. |
|--|--|------------------------------|----------|---------------------------------------|---------------------------|
| 771/772 735/742 745/750 ST200 S1000C/T Trennen Split cut | Obermesser Figur 2618(618) 425.00-0230.1/01 330 x 100 x 8 | 8/M10 | 1,75 | 028.90/023F236 | * |
| | | | | 028.90/023F3000 | * |
| | Untermesser Figur 2768(768) 425.00-4431.1/0d 336 x 70 x 8 (88° 30') | 6/M10 | 1,35 | 028.61F236 | * |

BREHMER/BREHMER-STAHL/HEIDELBERG

| Maschinen-Typ Type/Type/Tipo | Abmessungen in mm Size/Dimension/Tamaño | Löcher/Holes Trous/Huecos | kg | FASSCO-Id. Qualität/Quality/Calid. | €/Stück Pce./Pce./Pza. |
|--|--|------------------------------|------|---------------------------------------|---------------------------|
| 771/772 735/742 745/750 ST200 S1000C/T Stanzen Punch cut | Obermesser, 8 mm Figur 2767(767) 425.00-4429.1/0e 336 x 114/100 x 8 | 4/M10 | 2,05 | 028.62F236 | * |
| | Obermesser, 5 mm Figur 2766(766) 425.00-4430.1/0e 336 x 114/100 x 8/5 | 4/M10 | 1,70 | 028.63F236 | * |
| | Obermesser, 6 mm 336 x 114/100 x 8/6 | 4/M10 | 1,80 | 028.65F236 | * |
| | Obermesser, 10 mm 336 x 114/100 x 10 | 4/M10 | 2,55 | 028.69F236 | * |
| | Untermesser, links Figur 2765(765) 425.00-4428.1/0d 336 x 70 x 8 (20°) | 6/M10 | 1,10 | 028.64F236 | * |
| | Untermesser, rechts Figur 2765(765) 425.00-4428.1/0d 336 x 70 x 8 (20°) | 6/M10 | 1,10 | 028.64F236 | * |

**CAMPEADOR**

| Maschinen-Typ Type/Type/Tipo | Abmessungen in mm Size/Dimension/Tamaño | Löcher/Holes Trous/Huecos | kg | FASSCO-Id. Qualität/Quality/Calid. | €/Stück Pce./Pce./Pza. |
|---------------------------------|--|------------------------------|------|---------------------------------------|---------------------------|
| | 520 x 60 x 6 (0183) | 5 5/16"NC | 1,20 | 063.02F220 | * |
| | 670 x 70 x 7,5 (0283-039) | 5 3/8"UNC | 2,40 | 063.03F220 | * |
| | | | | 063.03F3000 | * |
| | 800 x 115 x 10 (0287 080) | 14 3/8"UNF | 6,35 | 063.04F220 | * |
| | | | | 063.04F3000 | * |
| 72 | 830 x 100 x 8 (1770 102 00) | 10 1/2"– 20NF | 4,55 | 063.01F220 | * |
| | | | | 063.01F3000 | * |
| 82/84* S-32 | 980 x 120 x 10 | 8 | 8,10 | 063.05F220 | * |
| | | | | 063.05F3000 | * |

*Für diese CAMPEADOR-Typen ist eine Zeichnung erforderlich.

*For these CAMPEADOR -types a drawing is required.

CAUHÉ



| Maschinen-Typ Type/Type/Tipo | Abmessungen in mm Size/Dimension/Tamaño | Löcher/Holes Trous/Huecos | ⚖️ kg | FASSCO-Id. Qualität/Quality/Calid. | €/Stück Pce./Pce./Pza. |
|---------------------------------|--|------------------------------|----------|---------------------------------------|---------------------------|
| GH-82 32" | 1030 x 124 x 10 | 16/M14 2 Nuten | 9,50 | 122.07F220 | * |
| | | | | 122.07F3000 | * |
| GH-200 78.7" | 2340 x 160 x 16 | 34/M12 2/M6 | 41,30 | 122.02F220 | * |
| | | | | 122.02F3000 | * |
| GH-260 102" | 2940 x 160 x 16 | 46/M12 2/M6 | 51,90 | 122.03F220 | * |
| | | | | 122.03F3000 | * |
| GH-320 125" | 3540 x 160 x 16 | 54/M12 2/M6 | 62,50 | 122.04F220 | * |
| | | | | 122.04F3000 | * |
| GH-366 144" | 4000 x 160 x 16 | 62/M12 2/M6 | 70,60 | 122.05F220 | * |
| | | | | 122.05F3000 | * |

CEELEN



| Maschinen-Typ Type/Type/Tipo | Abmessungen in mm Size/Dimension/Tamaño | Löcher/Holes Trous/Huecos | ⚖️ kg | FASSCO-Id. Qualität/Quality/Calid. | €/Stück Pce./Pce./Pza. |
|---------------------------------|--|------------------------------|----------|---------------------------------------|---------------------------|
| 77 | 925 x 110 x 11 | 14/M10 | 7,75 | 081.02F220 | * |
| | | | | 081.02F3000 | * |
| 76/78 | 940 x 127 x 12,7 | 16/M12 + MWE | 10,50 | 081.04F220 | * |
| | | | | 081.04F3000 | * |
| 78 neu/new | 960 x 127 x 12,7 | 16/M12 + MWE | 10,55 | 081.03F220 | * |
| | | | | 081.03F3000 | * |
| QZ 92 | 1085 x 127 x 12,5 | 14/M12 + MWE | 11,90 | 081.01F220 | * |
| | | | | 081.01F3000 | * |

CHALLENGE



| Maschinen-Typ Type/Type/Tipo | Abmessungen in mm Size/Dimension/Tamaño | Löcher/Holes Trous/Huecos | ⚖️ kg | FASSCO-Id. Qualität/Quality/Calid. | €/Stück Pce./Pce./Pza. |
|--|--|------------------------------|----------|---------------------------------------|---------------------------|
| 13" C 60 13 Challenge | 355,6 x 63,5 x 6,35 14" x 2.5" x .250" (13-107) | 4 3/8"-16 | 0,98 | 050.01F220 | * |
| | | | | 050.01F3000 | * |
| CMT 130 | 444,5 x 76,2 x 9,52 17.1/2" x 3" x .375" (59051-2) | 7 3/8"-16 | 2,22 | 050.45F220 | * |
| | | | | 050.45F3000 | * |
| 14" | 450,85 x 76,2 x 9,52 17.75" x 3" x .375" (41001) | 4 3/8"-16 | 2,25 | 050.40F220 | * |
| | | | | 050.40F3000 | * |
| 16-1/4" 16/162 Chal- lenge 16 Advance | 520,7 x 88,9 x 9,50 20.5" x 3.5" x .374" (2100) | 8 3/8"-16 | 3,04 | 050.02F220 | * |
| | | | | 050.02F3000 | * |
| Model 20 | 603,2 x 76,2 x 9,52 23.75" x 3" x .375" (A10034) | 4 3/8"-16 | 3,05 | 050.39F220 | * |
| | | | | 050.39F3000 | * |
| 19-3/8" 193 H Challenge | 609,6 x 88,9 x 9,50 24" x 3.5" x .374" (2122-2) | 8 3/8"-16 | 3,55 | 050.03F220 | * |
| | | | | 050.03F3000 | * |

CHALLENGE

| Maschinen-Typ Type/Type/Tipo | Abmessungen in mm Size/Dimension/Tamaño | Löcher/Holes Trous/Huecos |  kg | FASSCO-Id. Qualität/Quality/Calid. | €/Stück Pce./Pce./Pza. |
|--|---|--|---|---------------------------------------|---------------------------|
| 19-3/8" 19/193 Chal- lenge 19 Advance | 609,6 x 88,9 x 9,50 24" x 3.5" x .374" (2122-1) | 10 3/8"-16 | 3,55 | 050.05F220 | * |
| | | | | 050.05F3000 | * |
| 193 Diamond | 622,3 x 101,6 x 9,50 24.5" x 4" x .374" (2122-4) | 8 3/8"-16 | 4,15 | 050.24F220 | * |
| | | | | 050.24F3000 | * |
| 23" TITAN 230 | 679,45 x 76,2 x 9,53 26.75" x 3" x .375" (42007-1) | 5 3/8"-16 | 3,40 | 050.47F220 | * |
| | | | | 050.47F3000 | * |
| 23" 230 H Challen- ge | 685,8 x 88,9 x 9,50 27" x 3.5" x .374" (230-2122-2) | 10 3/8"-16 (Tlg. 4.1/2") | 4,00 | 050.12F220 | * |
| | | | | 050.12F3000 | * |
| 23" 230 MB | 685,8 x 101,6 x 9,50 27" x 4" x .374" (230-2122-3) | 10 3/8"-16 (Tlg. 4.1/2") | 4,55 | 050.08F220 | * |
| | | | | 050.08F3000 | * |
| 22-1/2" 22-1/2" Advan- ce | 685,8 x 101,6 x 9,50 27" x 4" x .374" (2271) | 10 1/2"-12 (Tlg. 5.3/16") | 4,55 | 050.06F220 | * |
| | | | | 050.06F3000 | * |
| 22-1/2" | 685,8 x 101,6 x 11 27" x 4" x .433" | 10 1/2"-12 (Tlg. 6") | 5,25 | 050.41F220 | * |
| | | | | 050.41F3000 | * |
| 23" 230 F Challenge | 711,2 x 88,9 x 9,50 28" x 3.5" x .374" (230-2122) | 10 3/8"-16 (Tlg. 5.13/16") | 4,15 | 050.13F220 | * |
| | | | | 050.13F3000 | * |
| 23" 230 FS Chal- lenge | 711,2 x 88,9 x 9,50 28" x 3.5" x .374" (230-2122-1) | 10 3/8"-16 (Tlg. 4.3/8") | 4,15 | 050.14F220 | * |
| | | | | 050.14F3000 | * |
| 25" 25" Advance | 749,3 x 101,6 x 9,50 29.1/2" x 4" x .374" (2270) | 12 1/2"-12 (Tlg. 5.1/8") | 5,00 | 050.44F220 | * |
| | | | | 050.44F3000 | * |
| 25-1/2" 25-1/2" Advan- ce | 762 x 101,6 x 9,50 30" x 4" x .374" (2211) | 12 1/2"-12 (Tlg. 5.1/8") | 5,05 | 050.15F220 | * |
| | | | | 050.15F3000 | * |
| 25-1/4" 25 Challenge | 762 x 114,3 x 9,50 30" x 4.5" x .374" (2272) | 12 1/2"-12 (Tlg. 1*5.1/4"- 4*5.5/16") | 5,73 | 050.16F220 | * |
| | | | | 050.16F3000 | * |
| 26-1/2" 265 C Challenge | 762 x 101,6 x 9,50 30" x 4" x .374" (2263-1) | 10 1/2"-12 | 5,05 | 050.17F220 | * |
| | | | | 050.17F3000 | * |
| 26-5/8" 265 F Challenge 26-1/2" Advance | 781,05 x 101,6 x 9,50 30.3/4" x 4" x .374" (2263) | 12 1/2"-12 | 5,22 | 050.09F220 | * |
| | | | | 050.09F3000 | * |
| 26-5/8" 265 H Challen- ge | 781,05 x 101,6 x 9,50 30.3/4" x 4" x .374" (2263-2) | 12 3/8"-16 | 5,22 | 050.18F220 | * |
| | | | | 050.18F3000 | * |
| 265 Diamond | 793,75 x 101,6 x 9,50 31.25" x 4" x .374" (2263-4) | 12 3/8"-16 | 5,30 | 050.25F220 | * |
| | | | | 050.25F3000 | * |
| 30-1/2" 305 C Challenge | 863,6 x 101,6 x 9,50 34" x 4" x .374" (2238-1) | 12 1/2"-12 | 5,75 | 050.19F220 | * |
| | | | | 050.19F3000 | * |

CHALLENGE



| Maschinen-Typ Type/Type/Tipo | Abmessungen in mm Size/Dimension/Tamaño | Löcher/Holes Trous/Huecos | ⚖️ kg | FASSCO-Id. Qualität/Quality/Calid. | €/Stück Pce./Pce./Pza. |
|---|---|------------------------------|----------|---------------------------------------|---------------------------|
| 30-1/2" 305 H Challenge Power & Lever | 882,65 x 101,6 x 9,50 34.3/4" x 4" x .374" (2238-2) | 12 3/8"-16 | 5,90 | 050.10F220 | * |
| | | | | 050.10F3000 | * |
| 30-1/2" 305 F Challenge 30 Advance | 889 x 101,6 x 11 35" x 4" x .433" (2238) | 14 1/2"-12 | 6,90 | 050.04F220 | * |
| | | | | 050.04F3000 | * |
| 30-1/4" 30 Challenge Power | 889 x 127 x 12,6 35" x 5" x .496" (2274) | 14 1/2"-12 | 9,88 | 050.22F220 | * |
| | | | | 050.22F3000 | * |
| 30-1/4" 30 Challenge Lever | 889 x 114,3 x 12,6 35" x 4.5" x .496" (2273) | 14 1/2"-12 | 8,90 | 050.23F220 | * |
| | | | | 050.23F3000 | * |
| 305 Diamond | 895,35 x 101,6 x 9,50 35.25" x 4" x .374" (2238-4) | 12 3/8"-16 | 5,95 | 050.26F220 | * |
| | | | | 050.26F3000 | * |
| 30-1/2" 98-Mod. 305 X | 908 x 101,6 x 9,50 35.75" x 4" x .374" | 12 3/8"-16 | 6,05 | 050.37F220 | * |
| | | | | 050.37F3000 | * |
| 30-1/2" 30 Diamond (4-1/2") | 914,4 x 114,3 x 11 36" x 4.5" x .433" (5-142) | 14 1/2"-12 | 7,95 | 050.20F220 | * |
| | | | | 050.20F3000 | * |
| 30-1/2" 30-1/2" Dia- mond (4") | 914,4 x 101,6 x 11 36" x 4" x .433" (5-142-1) | 14 1/2"-12 | 7,05 | 050.21F220 | * |
| | | | | 050.21F3000 | * |
| 32" Power | 939,8 x 127 x 12,7 37" x 5" x .500" (2276) | 7 1/2"-12 | 10,50 | 050.34F220 | * |
| | | | | 050.34F3000 | * |
| 32" Lever | 939,8 x 114,3 x 12,7 37" x 4.5" x .500" (2275) | 7 1/2"-12 | 9,45 | 050.35F220 | * |
| | | | | 050.35F3000 | * |
| 32-1/2" Dia- mond | 965,2 x 114,3 x 11,11 38" x 4.5" x 7/16" (6-142) | 14 1/2"-12 | 8,50 | 050.33F220 | * |
| | | | | 050.33F3000 | * |
| 33-1/2" Chal- lenge 33" Advance | 977,9 x 101,6 x 11,11 38.1/2" x 4" x 7/16" (2239) | 7 1/2"-12 | 7,65 | 050.32F220 | * |
| | | | | 050.32F3000 | * |
| 34" Diamond (4-1/2") | 1041,4 x 114,3 x 11,1 41" x 4.1/2" x .437" (7-142) | 14 1/2"-12 | 9,15 | 050.29F220 | * |
| | | | | 050.29F3000 | * |
| 34-1/2" Dia- mond (4") | 1041,4 x 101,6 x 11,1 41" x 4" x .437" (7-142-1) | 14 1/2"-12 | 8,15 | 050.30F220 | * |
| | | | | 050.30F3000 | * |
| 36" Power | 1060,45 x 127 x 12,7 41.3/4" x 5" x .500" (2277) | 8 5/8"-11 | 11,90 | 050.36F220 | * |
| | | | | 050.36F3000 | * |
| 36-1/2" Dia- mond 36" | 1066,8 x 101,6 x 11,1 42" x 4" x .437" (8-142-1) | 12 1/2"-12 | 8,35 | 050.27F220 | * |
| | | | | 050.27F3000 | * |
| 37" 370 XG | 1098,8 x 114,3 x 9,50 43.26" x 4.50" x .374" | 18 3/8"-16 | 8,25 | 050.38F220 | * |
| | | | | 050.38F3000 | * |

CHALLENGE

| Maschinen-Typ Type/Type/Tipo | Abmessungen in mm Size/Dimension/Tamaño | Löcher/Holes Trous/Huecos | ⚖️ kg | FASSCO-Id. Qualität/Quality/Calid. | €/Stück Pce./Pce./Pza. |
|---------------------------------|--|------------------------------|----------|---------------------------------------|---------------------------|
| 37" 370 CH | 1117,6 x 127 x 11,1 44" x 5" x .438" (9-142) | 18 1/2"-12 | 10,90 | 050.31F220 | * |
| | | | | 050.31F3000 | * |
| 37" Power | 1130,3 x 127 x 10,95 44.1/2" x 5" x .431" (9-142-1) | 18 3/8"-16 | 10,90 | 050.11F220 | * |
| | | | | 050.11F3000 | * |
| 420 | 1244,6 x 127 x 10,97 49" x 5" x .432" (10-142) | 21 1/2"-12 | 12,05 | 050.28F220 | * |
| | | | | 050.28F3000 | * |
| 42 TCM | 1257,3 x 127 x 10,95 49.1/2" x 5" x .431" (10-142-1) | 21 3/8"-16 | 12,10 | 050.07F220 | * |
| | | | | 050.07F3000 | * |

CHALLENGE

(Einmesser Dreischneider)

| Maschinen-Typ Type/Type/Tipo | Abmessungen in mm Size/Dimension/Tamaño | Löcher/Holes Trous/Huecos | ⚖️ kg | FASSCO-Id. Qualität/Quality/Calid. | €/Stück Pce./Pce./Pza. |
|---|---|------------------------------|----------|---------------------------------------|---------------------------|
| Dreischneider Three knife Tr. CMT-330 | 368,3 x 69,85 x 9,52 14.1/2" x 2.75" x .375" | 6 3/8"-16 2 =ø3,6mm | 1,50 | 050.43F3000 | 142,00 |

CHALLENGE

| Maschinen-Typ Type/Type/Tipo | Abmessungen in mm Size/Dimension/Tamaño | Löcher/Holes Trous/Huecos | ⚖️ kg | FASSCO-Id. Qualität/Quality/Calid. | €/Stück Pce./Pce./Pza. |
|--|--|------------------------------|----------|---------------------------------------|---------------------------|
| Dreischneider Three Knife Tr. Modell A | Vordermesser 330,2 x 127 x 12,7 13" x 5" x .500" (6248) | 4 1/2"-13NC 1 vers.Loch | 3,70 | 050.90/001F220 | 199,00 |
| | | | | 050.90/001F3000 | 255,00 |
| | Seitenmesser, links 304,8 x 127 x 12,7 12" x 5" x .500" (6247) | 4 1/2"-13NC 1 1/4"-20NC | 3,40 | 050.90/002F220 | 199,00 |
| | | | | 050.90/002F3000 | 255,00 |
| | Seitenmesser, rechts 304,8 x 127 x 12,7 12" x 5" x .500" (6249) | 4 1/2"-13NC 1 Nute | 3,40 | 050.90/003F220 | 199,00 |
| | | | | 050.90/003F3000 | 255,00 |
| €/Satz/Set/Jeu/Juego | | | | | |
| Dreischneider Three Knife Tr. Modell A | kompletter Satz complete set | = 3 Messer = 3 knives | 10,50 | 050.90/300F220 | 597,00 |
| | | | | 050.90/300F3000 | 765,00 |

CHANDLER & PRICE



| Maschinen-Typ Type/Type/Tipo | Abmessungen in mm Size/Dimension/Tamaño | Löcher/Holes Trous/Huecos | △ kg | FASSCO-Id. Qualität/Quality/Calid. | €/Stück Pce./Pce./Pza. |
|---------------------------------|--|------------------------------|---------|---------------------------------------|---------------------------|
| | 381 x 76,2 x 6,35 15" x 3" x .250" | 8 3/8"-16NC | 1,26 | 059.05F220 | * |
| | | | | 059.05F3000 | * |
| 19" | 584,2 x 82,6 x 9,52 23" x 3.1/4" x .375" (1927-A) | 4 3/8"-16 | 3,20 | 059.11F220 | * |
| | | | | 059.11F3000 | * |
| 23" Bench Cutter | 685,8 x 82,6 x 9,52 27" x 3.1/4" x .375" (BR-2327) | 5 3/8"-16 | 3,75 | 059.10F220 | * |
| | | | | 059.10F3000 | * |
| 23" HY | 685,8 x 101,6 x 9,52 27" x 4" x .375" (HY-2327) | 10 1/2"-12 | 4,60 | 059.09F220 | * |
| | | | | 059.09F3000 | * |
| 26" | 762 x 101,6 x 9,52 30" x 4" x .375" (2627-A) | 12 1/2"-12 | 5,10 | 059.04F220 | * |
| | | | | 059.04F3000 | * |
| 30" HY 30-1/2" | 863,6 x 101,6 x 9,52 34" x 4" x .375" (HY-3027) | 14 1/2"-12 | 5,80 | 059.06F220 | * |
| | | | | 059.06F3000 | * |
| 34" Craftsman | 1016 x 101,6 x 9,52 40" x 4" x .375" (X3427A) | 16 1/2"-12 | 6,80 | 059.02F220 | * |
| | | | | 059.02F3000 | * |
| 37" Auto Cutter | 1117,6 x 101,6 x 11,1 44" x 4" x .437" (X3727) | 16 1/2"-12 | 8,70 | 059.01F220 | * |
| | | | | 059.01F3000 | * |
| | 1143,0 x 101,6 x 11,1 45" x 4" x .437" | 16 1/2"-13 | 8,90 | 059.12F220 | * |
| | | | | 059.12F3000 | * |
| 39" 40" | 1270 x 127 x 12,65 50" x 5" x .498" (40-27) | 18 1/2"-12 | 14,10 | 059.07F220 | * |
| | | | | 059.07F3000 | * |
| 44" Auto Cutter | 1397 x 127 x 12,7 55" x 5" x .500" (44-27) | 20 1/2"-12 | 15,78 | 059.08F220 | * |
| | | | | 059.08F3000 | * |
| 50" | 1524 x 127 x 12,65 60" x 5" x .498" (50-27) | 22 1/2"-12 | 17,00 | 059.03F220 | * |
| | | | | 059.03F3000 | * |

Für alle Chandler&Price-Typen ist eine Zeichnung erforderlich. / For all Chandler&Price-types a drawing is required.

COL-TEC

| Maschinen-Typ Type/Type/Tipo | Abmessungen in mm Size/Dimension/Tamaño | Löcher/Holes Trous/Huecos | △ kg | FASSCO-Id. Qualität/Quality/Calid. | €/Stück Pce./Pce./Pza. |
|---------------------------------|---|------------------------------|---------|---------------------------------------|---------------------------|
| STITCH FOLD TRIMMER | Obermesser 14.75" 374,65 x 127/101,6 x 12,7 (P6557) | 5 Langlöcher 2/M12 | 3,35 | 149.90/001F236 | * |
| | Untermesser 15" 381 x 24,89 x 12,7 (P6558) | 5 zyl. vers. Langlöcher | 0,80 | 149.90/101F236 | * |

| Maschinen-Typ Type/Type/Tipo | Abmessungen in mm Size/Dimension/Tamaño | Löcher/Holes Trous/Huecos | △ kg | FASSCO-Id. Qualität/Quality/Calid. | €/Stück Pce./Pce./Pza. |
|---------------------------------|--|------------------------------|---------|---------------------------------------|---------------------------|
| STITCH FOLD TRIMMER | Obermesser 404,65 x 127/101 x 12,7 (P6555) | 5 Langlöcher 2/M12 | 3,60 | 149.91/001F236 | * |
| | Untermesser 411 x 24,89 x 12,7 (P6556) | 5 zyl. vers. Langlöcher | 0,85 | 149.91/101F236 | * |



| Maschinen-Typ Type/Type/Tipo | Abmessungen in mm Size/Dimension/Tamaño | Löcher/Holes Trous/Huecos | △ kg | FASSCO-Id. Qualität/Quality/Calid. | €/Stück Pce./Pce./Pza. |
|---------------------------------|--|------------------------------|---------|---------------------------------------|---------------------------|
| FTP 76 | 815 x 117 x 10 | 16/M10 | 6,60 | 045.07F220 | * |
| | | | | 045.07F3000 | * |
| FA 76 FA 78 | 940 x 127 x 12,7 | 16/M12 + MWE | 10,50 | 013.01F220 | * |
| | | | | 013.01F3000 | * |
| 780 (Guo Wang) | 960 x 127 x 12,7 (780-5A) | 16/M12 +MWE | 10,70 | 137.01F220 | * |
| | | | | 137.01F3000 | * |
| FA78/780 (Donix) | 960 x 110 x 11,7 (7805001A) | 18/M10 +MWE | 8,30 | 150.32F220 | * |
| | | | | 150.32F3000 | * |
| TGF 78 FA 78 | 970 x 127 x 12,7 | 16/M12 + MWE | 10,85 | 013.06F220 | * |
| | | | | 013.06F3000 | * |
| FTP 82 Hy | 1076 x 116 x 9,1 | 16/M10 | 7,85 | 045.01F220 | * |
| | | | | 045.01F3000 | * |
| FA 92 | 1080 x 127 x 12,7 | 18/M12 +MWE | 12,10 | 013.02F220 | * |
| | | | | 013.02F3000 | * |
| 920 Neu | 1100 x 127 x 12,7 | 18/M12 +MWE | 12,25 | 150.01F220 | * |
| | | | | 150.01F3000 | * |
| FTP 107 (alt) | 1310 x 140 x 12 | 20/M12 | 15,25 | 045.05F220 | * |
| | | | | 045.05F3000 | * |
| FTP 107 Hy-S | 1310 x 150 x 12,1 | 30/M12 | 16,50 | 045.02F220 | * |
| | | | | 045.02F3000 | * |
| FTP 112 (alt) | 1340 x 150 x 13,8 | 24/M12 | 19,25 | 045.06F220 | * |
| | | | | 045.06F3000 | * |
| FTP 112 Hy-S FTP 115 Hy-S | 1340 x 150 x 13,8 | 30/M12 | 19,20 | 045.03F220 | * |
| | | | | 045.03F3000 | * |
| FTP 112 Hy-S FTP 115 Hy-S | 1345 x 150 x 13,8 | 30/M12 | 19,30 | 045.04F220 | * |
| | | | | 045.04F3000 | * |
| FA 115 | 1390 x 160 x 12,7 | 22/M12 +MWE | 19,60 | 013.03F220 | * |
| | | | | 013.03F3000 | * |
| FTP 115 FA 115 | 1390 x 160 x 13,5 | 26/M12 +MWE | 20,00 | 045.14F220 | * |
| | | | | 045.14F3000 | * |
| FA 137 | 1605 x 160 x 12,7 | 26/M12 +MWE | 22,65 | 013.04F220 | * |
| | | | | 013.04F3000 | * |
| FA 155 | 1790 x 160 x 12,7 | 28/M12 +MWE | 25,20 | 013.05F220 | * |
| | | | | 013.05F3000 | * |
| FA 176 | 1905 x 160 x 13,75 | 36/M12 +MWE | 29,20 | 013.08F220 | * |
| | | | | 013.08F3000 | * |

COMO



| Maschinen-Typ Type/Type/Tipo | Abmessungen in mm Size/Dimension/Tamaño | Löcher/Holes Trous/Huecos | kg | FASSCO-Id. Qualität/Quality/Calid. | €/Stück Pce./Pce./Pza. |
|---------------------------------|--|------------------------------|-------|---------------------------------------|---------------------------|
| 78 H1/S1 31" | 995 x 135 x 10 (4062) | 14/M10 | 9,30 | 031.01F220 | * |
| | | | | 031.01F3000 | * |
| 92 H2/S2 36" | 1125 x 135 x 12 (4111) | 18/M10 | 12,65 | 031.02F220 | * |
| | | | | 031.02F3000 | * |
| 110 H3/S3 43-1/4" | 1315 x 135 x 12 (4385-1) | 30/M10 +MWE | 14,75 | 031.04F220 | * |
| | | | | 031.04F3000 | * |
| 115 H4/S4 45" | 1339 x 135 x 13 (4385-2) | 20/M10 | 16,30 | 031.05F220 | * |
| | | | | 031.05F3000 | * |

| Maschinen-Typ Type/Type/Tipo | Abmessungen in mm Size/Dimension/Tamaño | Löcher/Holes Trous/Huecos | kg | FASSCO-Id. Qualität/Quality/Calid. | €/Stück Pce./Pce./Pza. |
|---------------------------------|--|------------------------------|-------|---------------------------------------|---------------------------|
| 82 HY 32" | 1100 x 127 x 10 (1829) | 16 3/8"W | 9,68 | 031.03F220 | * |
| | | | | 031.03F3000 | * |
| 92 | 1155 x 127 x 12,65 (8442) | 24/M10 +MWE | 12,85 | 031.22F220 | * |
| | | | | 031.22F3000 | * |
| 110 | 1290 x 135 x 10 (B-3611) | 20/M10 | 12,05 | 031.06F220 | * |
| | | | | 031.06F3000 | * |
| 115 | 1371,6 x 127 x 12,65 (4385-4) | 30/M10 +MWE | 15,25 | 031.13F220 | * |
| | | | | 031.13F3000 | * |
| 155 | 1870 x 127 x 12,65 (1760) | 26 1/2"W | 20,85 | 031.07F220 | * |
| | | | | 031.07F3000 | * |

| Maschinen-Typ Type/Type/Tipo | Abmessungen in mm Size/Dimension/Tamaño | Löcher/Holes Trous/Huecos | kg | FASSCO-Id. Qualität/Quality/Calid. | €/Stück Pce./Pce./Pza. |
|---|--|------------------------------|-------|---------------------------------------|---------------------------|
| H1 31" (*) | 990 x 127 x 12,65 | 14 1/2"W | 11,00 | 031.09F220 | * |
| | | | | 031.09F3000 | * |
| H2 92 (*) 36-1/4" | 1118 x 127 x 12,65 | 18 1/2"W | 12,45 | 031.10F220 | * |
| | | | | 031.10F3000 | * |
| H3 109 43" (*) H3 110 43-1/4" (*) | 1320 x 127 x 12,65 | 20 1/2"W | 14,70 | 031.11F220 | * |
| | | | | 031.11F3000 | * |
| H4 114 45" (*) H4 115 45-1/4" (*) | 1346 x 127 x 12,65 | 20 1/2"W | 15,00 | 031.12F220 | * |
| | | | | 031.12F3000 | * |

* Für diese COMO-Typen ist eine Zeichnung erforderlich. / * For these COMO-types a drawing is required.

COMO



| Maschinen-Typ Type/Type/Tipo | Abmessungen in mm Size/Dimension/Tamaño | Löcher/Holes Trous/Huecos | kg | FASSCO-Id. Qualität/Quality/Calid. | €/Stück Pce./Pce./Pza. |
|---------------------------------|--|------------------------------|-------|---------------------------------------|---------------------------|
| Super 36-1/4" 92 | 1244,6 x 127 x 12,65 (1056) | 30 1/2"W | 13,85 | 031.14F220 | * |
| | | | | 031.14F3000 | * |
| Super 46" 117 | 1498,6 x 127 x 12,65 (1056) | 33 1/2"W | 16,70 | 031.15F220 | * |
| | | | | 031.15F3000 | * |
| Super 52" 132 | 1651 x 127 x 12,65 (1056) | 36 1/2"W | 18,40 | 031.16F220 | * |
| | | | | 031.16F3000 | * |



COMO

| Maschinen-Typ Type/Type/Tipo | Abmessungen in mm Size/Dimension/Tamaño | Löcher/Holes Trous/Huecos | kg | FASSCO-Id. Qualität/Quality/Calid. | €/Stück Pce./Pce./Pza. |
|---------------------------------|--|------------------------------|-------|---------------------------------------|---------------------------|
| Super 52" 132 | 1664 x 127 x 12,65 (1056) | 36/M12 +MWE | 18,55 | 031.17F220 | * |
| | | | | 031.17F3000 | * |
| Super 57" 145 | 1790,7 x 127 x 12,65 (1056) | 39 1/2"W | 19,95 | 031.18F220 | * |
| | | | | 031.18F3000 | * |
| Super 59" 150/155 | 1867 x 127 x 12,65 (1056-1) | 39/M12 +MWE | 20,85 | 031.19F220 | * |
| | | | | 031.19F3000 | * |
| Super 65" 165 | 2044,7 x 127 x 12,65 (1056-1) | 42 1/2"W | 22,80 | 031.20F220 | * |
| | | | | 031.20F3000 | * |
| Super 87" 220 | 2590,8 x 127 x 12,65 (1056-1) | 54/M12 oder/or 1/2"W | 28,90 | 031.21F220 | * |
| | | | | 031.21F3000 | * |

Bei Auftragserteilung aller COMO-Typen bitte die Gewindeart prüfen und angeben.
When placing orders for all COMO-types please check and indicate kind of thread.

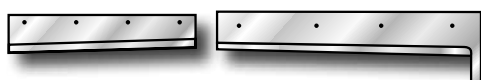

CONSOLIDATED

| Maschinen-Typ Type/Type/Tipo | Abmessungen in mm Size/Dimension/Tamaño | Löcher/Holes Trous/Huecos | kg | FASSCO-Id. Qualität/Quality/Calid. | €/Stück Pce./Pce./Pza. |
|---------------------------------|--|------------------------------|------|---------------------------------------|---------------------------|
| OT 3 Jetstream 225 | Vordermesser, oben (2009-43/1101) 520 x 141/76/61 x 10 | 4/M8 | 2,40 | 072.90/001F236 | * |
| | Seitenmesser, oben links (2009-40/1106) 355 x 65/55 x 10 | 4/M8 | 1,33 | 072.90/002F236 | * |
| | Seitenmesser, oben rechts (2009-40/1108) 355 x 65/55 x 10 | 4/M8 | 1,33 | 072.90/003F236 | * |
| | Vordermesser, unten (2009-44/1102) 500 x 40 x 15/10 | 5 vers.Lö. | 1,65 | 072.90/101F236 | * |
| | Seitenmesser, unten links (2009-42/1107) 360 x 40 x 15/10 | 3 vers.Lö. | 1,15 | 072.90/102F236 | * |
| | Seitenmesser, unten rechts (2009-42/1109) 360 x 40 x 15/10 | 3 vers.Lö. | 1,15 | 072.90/103F236 | * |
| €/Satz/Set/Jeu/Juego | | | | | |
| OT 3 Jetstream 225 | Satz Obermesser Set Upper knives | = 3 Messer = 3 knives | 5,06 | 072.90/300F236 | * |
| | Satz Untermesser Set Bottom knives | = 3 Messer = 3 knives | 3,95 | 072.90/303F236 | * |
| | kompletter Satz complete set | = 6 Messer = 6 knives | 9,01 | 072.90/600F236 | * |

CONSOLIDATED

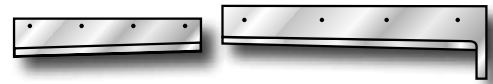

| Maschinen-Typ Type/Type/Tipo | Abmessungen in mm Size/Dimension/Tamaño | Löcher/Holes Trous/Huecos | △ kg | FASSCO-Id. Qualität/Quality/Calid. | €/Stück Pce./Pce./Pza. |
|---|---|------------------------------|---------|---------------------------------------|---------------------------|
| 341 Schwingschnitt Swing Cut | Vordermesser, oben (2009-43/1101) 520 x 141/76/61 x 10 | 4/M8 | 2,40 | 072.90/001F236 | * |
| | Seitenmesser, oben links (2009-41/TS-2006) 345 x 80/60/51 x 10 | 4/M8 | 1,30 | 072.91/002F236 | * |
| | Seitenmesser, oben rechts (2009-41/TS-2006) 345 x 80/60/51 x 10 | 4/M8 | 1,30 | 072.91/003F236 | * |
| | Vordermesser, unten (2009-44/1102) 500 x 40 x 15/10 | 5 vers.Lö. | 1,65 | 072.90/101F236 | * |
| | Seitenmesser, unten links (2009-42/1107) 360 x 40 x 15/10 | 3 vers.Lö. | 1,15 | 072.90/102F236 | * |
| | Seitenmesser, unten rechts (2009-42/1109) 360 x 40 x 15/10 | 3 vers.Lö. | 1,15 | 072.90/103F236 | * |
| €/Satz/Set/Jeu/Juego | | | | | |
| 341 Schwingschnitt Swing Cut | Satz Obermesser Set Upper knives | = 3 knives = 3 knives | 5,00 | 072.91/300F236 | * |
| | Satz Untermesser Set Bottom knives | = 3 Messer = 3 knives | 3,95 | 072.91/303F236 | * |
| | kompletter Satz complete set | = 6 Messer = 6 knives | 8,95 | 072.91/600F236 | * |

| Maschinen-Typ Type/Type/Tipo | Abmessungen in mm Size/Dimension/Tamaño | Löcher/Holes Trous/Huecos | △ kg | FASSCO-Id. Qualität/Quality/Calid. | €/Stück Pce./Pce./Pza. |
|---------------------------------------|--|------------------------------|---------|---------------------------------------|---------------------------|
| OT 3 Trennen Split cut | Obermesser (2009-45/2623-3) 350 x 96/82/60 x 6 | 5 Langlöcher | 0,97 | 072.64F236 | * |
| | Untermesser (2009-46/2622-3) 350 x 58 x 10/6 | 5/M6 | 1,06 | 072.65F236 | * |

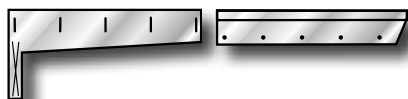

CONSOLIDATED

| Maschinen-Typ Type/Type/Tipo | Abmessungen in mm Size/Dimension/Tamaño | Löcher/Holes Trous/Huecos | △ kg | FASSCO-Id. Qualität/Quality/Calid. | €/Stück Pce./Pce./Pza. |
|---|---|------------------------------|---------|---------------------------------------|---------------------------|
| OT 3 Stanzen (4th & 5th) Punch cut | Obermesser, Fase 90° (2009-38-2/2603-3-1) 350 x 165/82/60 x 4 (5/32") | 5 Langlö. | 0,79 | 072.60/004F236 | * |
| | Obermesser, Fase 90° (2009-38/2603-3-2) 350 x 165/82/60 x 5 (3/16") | 5 Langlö. | 0,98 | 072.60/005F236 | * |
| | Obermesser, Fase 90° (2009-38-1/2603-3-3) 350 x 165/82/60 x 6 (1/4") | 5 Langlö. | 1,20 | 072.60/006F236 | * |
| | Obermesser, Fase 90° (2009-38/2603-3-4) 350 x 165/82/60 x 8 (5/16") | 5 Langlö. | 1,58 | 072.60/008F236 | * |
| | Obermesser, Fase 90° (2009-38/2603-3-5) 350 x 165/82/60 x 10 (3/8") | 5 Langlö. | 1,98 | 072.60/010F236 | * |
| | Obermesser, Fase 90° (2009-38-3/2603-3-6) 350 x 165/82/60 x 12 (1/2") | 5 Langlö. | 2,38 | 072.60/012F236 | * |
| | Untermesser, links (2009-39/2604-3 L) 350 x 58 x 6,0/5,7 | 5/M6 | 0,77 | 072.61/102F236 | * |
| | Untermesser, rechts (2009-39/2604-3 R) 350 x 58 x 6,0/5,7 | 5/M6 | 0,77 | 072.61/103F236 | * |



CORTA (RAPIER)

| Maschinen-Typ Type/Type/Tipo | Abmessungen in mm Size/Dimension/Tamaño | Löcher/Holes Trous/Huecos | △ kg | FASSCO-Id. Qualität/Quality/Calid. | €/Stück Pce./Pce./Pza. |
|---------------------------------|--|------------------------------|---------|---------------------------------------|---------------------------|
| 56 | 700 x 80 x 7,95 (4.05.03.41) | 7/M8 | 3,07 | 029.06F220 | * |
| | | | | 029.06F3000 | * |
| 56 MCD (ab 86) | 700 x 80 x 7,95 (4.08.02.10) | 14/M8 | 3,06 | 029.09F220 | * |
| | | | | 029.09F3000 | * |
| 58 | 760 x 95 x 6,68 (3.02.4.06) | 7/M8 | 3,30 | 029.01F220 | * |
| | | | | 029.01F3000 | * |
| CCM 67 | 780 x 103 x 10 | 5/M10 | 5,50 | 029.13F220 | * |
| | | | | 029.13F3000 | * |
| 72 neu | 870 x 105 x 10 (3.04.02.11) | 14/M10 | 6,30 | 029.04F220 | * |
| | | | | 029.04F3000 | * |
| 72 alt | 950 x 110 x 9,98 (3.01.4.06) | 7/M10 | 7,20 | 029.02F220 | * |
| | | | | 029.02F3000 | * |
| SM 78 | 980 x 118 x 9,95 (3.07.02.63) | 27/M10 | 7,90 | 029.08F220 | * |
| | | | | 029.08F3000 | * |
| 92 alt | 1200 x 115 x 12 (2.03.02.09) | 9/M12 | 11,50 | 029.03F220 | * |
| | | | | 029.03F3000 | * |
| 92 neu | 1200 x 115 x 12 (650-42.101.015) | 18/M12 | 11,40 | 029.05F220 | * |
| | | | | 029.05F3000 | * |

DAEGU – MODELL SABER

(Daegu Heavy Ind. Co. Ltd)

| Maschinen-Typ Type/Type/Tipo | Abmessungen in mm Size/Dimension/Tamaño | Löcher/Holes Trous/Huecos | ⚖️ kg | FASSCO-Id. Qualität/Quality/Calid. | €/Stück Pce./Pce./Pza. |
|---------------------------------|--|------------------------------|----------|---------------------------------------|---------------------------|
| 95 37" | 1172 x 140 x 12,70 | 22/M12 6/5Ø +MWE | 14,40 | 133.01F220 | * |
| | | | | 133.01F3000 | * |
| 1160 45,6" | 1390 x 160 x 13,75 | 26/M12 +MWE | 21,35 | 133.02F220 | * |
| | | | | 133.02F3000 | * |
| 1370 54" | 1605 x 160 x 13,75 | 30/M12 +MWE | 24,50 | 133.03F220 | * |
| | | | | 133.03F3000 | * |

DAHLE



| Maschinen-Typ Type/Type/Tipo | Abmessungen in mm Size/Dimension/Tamaño | Löcher/Holes Trous/Huecos | ⚖️ kg | FASSCO-Id. Qualität/Quality/Calid. | €/Stück Pce./Pce./Pza. |
|---------------------------------|--|------------------------------|----------|---------------------------------------|---------------------------|
| 510/540 36 | 418 x 50 x 6 | 6/M6 | 0,77 | 038.01F220 | * |
| | 420 x 50 x 6 | 3/M6 2/14Ø | 0,80 | 038.04F220 | * |
| 544 | 443 x 50 x 6 | 6/M6 | 0,85 | 038.03F220 | * |
| 852 | 460 x 40 x 6 | 3/M6 | 0,70 | 038.07F220 | * |
| 742 | 460 x 50 x 6 | 3/M6 | 0,90 | 038.06F220 | * |
| 545 46 | 530 x 50 x 6 | 7/M6 | 1,00 | 038.02F220 | * |
| 848 | 570 x 50 x 6 | 5/M6 | 1,08 | 038.05F220 | * |

DEXTER



| Maschinen-Typ Type/Type/Tipo | Abmessungen in mm Size/Dimension/Tamaño | Löcher/Holes Trous/Huecos | ⚖️ kg | FASSCO-Id. Qualität/Quality/Calid. | €/Stück Pce./Pce./Pza. |
|---------------------------------|--|------------------------------|----------|---------------------------------------|---------------------------|
| | 1194 x 127 x 12,45 (2099) | 18 1/2"-12 | 13,00 | 116.01F220 | * |
| | | | | 116.01F3000 | * |
| | 1346 x 127 x 12,45 (2524) | | 14,70 | 116.02F220 | * |
| | | | | 116.02F3000 | * |

* Für alle DEXTER-Typen ist eine Zeichnung erforderlich. / * For all DEXTER-types a drawing is required.

DGR GRAPHIC

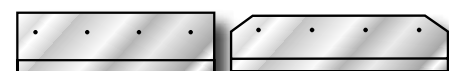

| Maschinen-Typ Type/Type/Tipo | Abmessungen in mm Size/Dimension/Tamaño | Löcher/Holes Trous/Huecos | kg | FASSCO-Id. Qualität/Quality/Calid. | €/Stück Pce./Pce./Pza. |
|---|--|------------------------------|-------|---------------------------------------|---------------------------|
| D.08 Dreischneider Three knife trim. | Vordermesser 520 x 110 x 12 (08-4-134) (08-4-105) | 4/M10 2/M6 | 4,50 | 138.90/001F3000 | 330,00 |
| | Seitenmesser, Kopf 420 x 110 x 12 (08-4-124) (08-4-104) | 4/M10 2/M6 | 3,70 | 138.90/002F3000 | 275,00 |
| | Seitenmesser, Fuß 420 x 110 x 12 (08-4-127) (08-4-103) | 4/M10 2/M6 | 3,70 | 138.90/003F3000 | 275,00 |
| €/Satz/Set/Jeu/Juego | | | | | |
| D.08 Dreischneider Three knife trim. | kompletter Satz complete set | = 3 Messer = 3 knives | 11,90 | 138.90/300F3000 | 880,00 |

Universal-Seitenmesser für Fuß- und Kopfbeschnitt
Universal side knife for head and tail cutting

| Maschinen-Typ Type/Type/Tipo | Abmessungen in mm Size/Dimension/Tamaño | Löcher/Holes Trous/Huecos | kg | FASSCO-Id. Qualität/Quality/Calid. | €/Stück Pce./Pce./Pza. |
|---------------------------------|---|------------------------------|------|---------------------------------------|---------------------------|
| | Seitenmesser, Kombi 420 x 110 x 12 (08-4-124/127) (08-4-103/104) | 8/M10 4/M6 | 3,70 | 138.90/023F3000 | 300,00 |



DIAMOND ACE

| Maschinen-Typ Type/Type/Tipo | Abmessungen in mm Size/Dimension/Tamaño | Löcher/Holes Trous/Huecos | kg | FASSCO-Id. Qualität/Quality/Calid. | €/Stück Pce./Pce./Pza. |
|---------------------------------|---|------------------------------|-------|---------------------------------------|---------------------------|
| | 965 x 114,3 x 14,3 38" x 4.1/2" x .564" | 18 1/2"W | 10,85 | 113.04F220 | * |
| | | | | 113.04F3000 | * |
| | 1016 x 114,3 x 14,3 40" x 4.1/2" x .564" | 20 1/2"W | 11,45 | 113.02F220 | * |
| | | | | 113.02F3000 | * |
| | 1219 x 114,3 x 14,3 48" x 4.1/2" x .564" | 24 1/2"W | 13,70 | 113.03F220 | * |
| | | | | 113.03F3000 | * |
| 42" | 1232 x 114,3 x 14,3 48.1/2" x 4.1/2" x .564" | 24 1/2"W | 13,85 | 113.01F220 | * |
| | | | | 113.01F3000 | * |
| 52" | 1537 x 114,3 x 14,3 60.1/2" x 4.1/2" x .564" | 30 1/2"W | 17,30 | 113.05F220 | * |
| | | | | 113.05F3000 | * |
| | 1791 x 114,3 x 14,3 70.1/2" x 4.1/2" x .564" | 34 1/2"W | 20,15 | 113.06F220 | * |
| | | | | 113.06F3000 | * |
| | 1845 x 114,3 x 14,3 72.5/8" x 4.1/2" x .564" | 36 1/2"W | 20,75 | 113.07F220 | * |
| | | | | 113.07F3000 | * |
| | 2045 x 114,3 x 14,3 80.1/2" x 4.1/2" x .564" | 40 1/2"W | 23,00 | 113.08F220 | * |
| | | | | 113.08F3000 | * |

DÖRRRIES - PRINTAX



| Maschinen-Typ Type/Type/Tipo | Abmessungen in mm Size/Dimension/Tamaño | Löcher/Holes Trous/Huecos | ⚖️ kg | FASSCO-Id. Qualität/Quality/Calid. | €/Stück Pce./Pce./Pza. |
|---------------------------------|--|------------------------------|----------|---------------------------------------|---------------------------|
| 78 | 945 x 100 x 10 | 12/M10 | 6,50 | 008.01F220 | * |
| | | | | 008.01F3000 | * |
| 80 | 950 x 120 x 12 | 12/M12 2/M10 | 9,45 | 008.05F220 | * |
| | | | | 008.05F3000 | * |
| 80 neu | 950 x 120 x 12 m.Ecke/chamf.corner | 12/M12 2/M10 | 9,40 | 008.06F220 | * |
| | | | | 008.06F3000 | * |
| 82 | 970 x 120 x 12 | 12/M12 2/M10 | 9,65 | 008.07F220 | * |
| | | | | 008.07F3000 | * |
| 86 92 | 1060 x 100 x 10 | 16/M10 | 7,35 | 008.02F220 | * |
| | | | | 008.02F3000 | * |
| 92 neu | 1060 x 120 x 12 | 14/M12 | 10,60 | 008.08F220 | * |
| | | | | 008.08F3000 | * |
| 107 | 1210 x 100 x 10 | 18/M10 | 8,40 | 008.03F220 | * |
| | | | | 008.03F3000 | * |
| 115 | 1428 x 160 x 14 | 26/M12 | 22,20 | 008.09F220 | * |
| | | | | 008.09F3000 | * |
| 138 | 1584 x 160 x 14 | 30/M12 | 24,65 | 008.04F220 | * |
| | | | | 008.04F3000 | * |
| 145 | 1728 x 160 x 14 | 30/M12 | 26,90 | 008.10F220 | * |
| | | | | 008.10F3000 | * |

DONGSHUL



| Maschinen-Typ Type/Type/Tipo | Abmessungen in mm Size/Dimension/Tamaño | Löcher/Holes Trous/Huecos | ⚖️ kg | FASSCO-Id. Qualität/Quality/Calid. | €/Stück Pce./Pce./Pza. |
|--|--|------------------------------|----------|---------------------------------------|---------------------------|
| Dreischneider Three knife trim. T-3 | Vordermesser 405 x 125 x 11 | 8/M10 | 3,80 | 135.90/001F220 | * |
| | | | | 135.90/001F3000 | * |
| | Seitenmesser, links 380 x 125 x 11 | 12/M10 | 3,50 | 135.90/023F220 | * |
| | | | | 135.90/023F3000 | * |
| | Seitenmesser, rechtss 380 x 125 x 11 | 12/M10 | 3,50 | 135.90/023F220 | * |
| | | | | 135.90/023F3000 | * |
| €/Satz/Set/Jeu/Juego | | | | | |
| Dreischneider Three knife trim. T-3 | kompletter Satz complete set | = 3 Messer = 3 knives | 10,80 | 135.90/300F220 | * |
| | | | | 135.90/300F3000 | * |

DUMOR

BOWAY / CEMPIRE



| Maschinen-Typ Type/Type/Tipo | Abmessungen in mm Size/Dimension/Tamaño | Löcher/Holes Trous/Huecos | △ kg | FASSCO-Id. Qualität/Quality/Calid. | €/Stück Pce./Pce./Pza. |
|---|--|------------------------------|---------|---------------------------------------|---------------------------|
| DigiCut 45 CB 450/ GR480 BW 450/480 | 504 x 42 x 6 | 7/M6 | 0,80 | 146.01F220 | * |
| | | | | 146.01F3000 | * |
| DigiCut 46 | 529 x 61 x 8 | 10/M8 | 1,68 | 146.07F220 | * |
| | | | | 146.07F3000 | * |
| DigiCut 52 HydroCut 52 CB 520 BW 520/550 | 600 x 65 x 8 | 7/M8 | 2,00 | 146.04F220 | * |
| | | | | 146.04F3000 | * |
| CE 520 | 600 x 70 x 8 | 14/M8 | 2,18 | 146.08F220 | * |
| | | | | 146.08F3000 | * |
| CB 520 | 600 x 75 x 7,9 | 7/M8 | 2,25 | 146.032F220 | * |
| | | | | 146.03F3000 | * |
| CB 650 BW 650/670 GR 670 | 763 x 85 x 10 | 7/M8 | 4,40 | 146.02F220 | * |
| | | | | 146.02F3000 | * |



DUPLO

| Maschinen-Typ Type/Type/Tipo | Abmessungen in mm Size/Dimension/Tamaño | Löcher/Holes Trous/Huecos | △ kg | FASSCO-Id. Qualität/Quality/Calid. | €/Stück Pce./Pce./Pza. |
|------------------------------------|--|------------------------------|---------|---------------------------------------|---------------------------|
| Sunray 490 | 610 x 85 x 8 | 5/M10 | 2,85 | 082.02F220 | * |
| | | | | 082.02F3000 | * |
| Sunray 520 | 625 x 85 x 8 | 5/M10 | 2,95 | 082.04F220 | * |
| | | | | 082.04F3000 | * |
| Sunray 660/680 PFI 660 26.5" | 780 x 100 x 8 m.Ecken/chamf.corners | 5/M12 | 4,25 | 082.01F220 | * |
| | | | | 082.01F3000 | * |
| PFI 660/680 26.5" | 790 x 100 x 8 | 5/M12 | 4,30 | 082.03F220 | * |
| | | | | 082.03F3000 | * |
| Sunray 720 | 850 x 100 x 8 | 5/M12 | 5,00 | 082.05F220 | * |
| | | | | 082.05F3000 | * |
| Sunray 800 | 930 x 100 x 8 | 5/M12 | 5,20 | 082.06F220 | * |
| | | | | 082.06F3000 | * |

DUPLO



| Maschinen-Typ Type/Type/Tipo | Abmessungen in mm Size/Dimension/Tamaño | Löcher/Holes Trous/Huecos | ⚖️ kg | FASSCO-Id. Qualität/Quality/Calid. | €/Stück Pce./Pce./Pza. |
|---------------------------------|--|------------------------------|----------|---------------------------------------|---------------------------|
| DC 8000 | Obermesser 360 x 120/65/55 x 12 | 2/M6 4/6,5 Ø | 1,55 | 082.90/001F236 | * |
| | Untermesser 360 x 30 x 15 | 4 zyl.vers. Langlöcher | 1,10 | 082.90/101F236 | * |

| Maschinen-Typ Type/Type/Tipo | Abmessungen in mm Size/Dimension/Tamaño | Löcher/Holes Trous/Huecos | ⚖️ kg | FASSCO-Id. Qualität/Quality/Calid. | €/Stück Pce./Pce./Pza. |
|---------------------------------|--|------------------------------|----------|---------------------------------------|---------------------------|
| DC 10000 | Obermesser 360 x 135/80/70 x 12 | 2/M6 8/6,5 Ø | 2,20 | 082.91/001F236 | * |
| | Untermesser 360 x 38 x 15 | 4 zyl.vers. Langlöcher | 1,50 | 082.91/101F236 | * |

| Maschinen-Typ Type/Type/Tipo | Abmessungen in mm Size/Dimension/Tamaño | Löcher/Holes Trous/Huecos | ⚖️ kg | FASSCO-Id. Qualität/Quality/Calid. | €/Stück Pce./Pce./Pza. |
|---------------------------------|--|------------------------------|----------|---------------------------------------|---------------------------|
| DBM 100T | Obermesser 343 x 85/78/68 x 8 | 2/M8 8/6,5 Ø | 1,30 | 082.93/001F236 | * |
| | Untermesser 353 x 37 x 15/9 | 4 zyl.vers. Langlöcher | 1,35 | 082.93/101F236 | * |

| Maschinen-Typ Type/Type/Tipo | Abmessungen in mm Size/Dimension/Tamaño | Löcher/Holes Trous/Huecos | ⚖️ kg | FASSCO-Id. Qualität/Quality/Calid. | €/Stück Pce./Pce./Pza. |
|---------------------------------|--|------------------------------|----------|---------------------------------------|---------------------------|
| DBM 120T | Obermesser 343 x 85/79/69 x 8 | 2/M6 12/6,5 Ø | 1,30 | 082.94/001F236 | 305,00 |
| | Untermesser 353 x 37 x 15/9 | 4 zyl.vers. Langlöcher | 1,35 | 082.93/101F236 | 225,00 |

| Maschinen-Typ Type/Type/Tipo | Abmessungen in mm Size/Dimension/Tamaño | Löcher/Holes Trous/Huecos | ⚖️ kg | FASSCO-Id. Qualität/Quality/Calid. | €/Stück Pce./Pce./Pza. |
|--|--|------------------------------|----------|---------------------------------------|---------------------------|
| DBM 250T DBM 400T DBM 500T Serie 4000 | Obermesser 410 x 135/80/69 x 12 | 2/M6 10/7 Ø 6/M4 | 2,40 | 082.92/001F236 | 456,00 |
| | Untermesser 410 x 33 x 15 | 4 zyl.vers. Langlöcher | 1,45 | 082.92/101F236 | 225,00 |

| Maschinen-Typ Type/Type/Tipo | Abmessungen in mm Size/Dimension/Tamaño | Löcher/Holes Trous/Huecos | ⚖️ kg | FASSCO-Id. Qualität/Quality/Calid. | €/Stück Pce./Pce./Pza. |
|---------------------------------|--|------------------------------|----------|---------------------------------------|---------------------------|
| DBM 350 T | Obermesser 354 x 85/78/68 x 8 | 12/6,6 Ø 2/M6 | 1,35 | 082.95/001F236 | 305,00 |
| | Untermesser 362 x 36 x 15 | 4 zyl.vers. Langlöcher | 1,35 | 082.95/101F236 | 225,00 |

| Maschinen-Typ Type/Type/Tipo | Abmessungen in mm Size/Dimension/Tamaño | Löcher/Holes Trous/Huecos | ⚖️ kg | FASSCO-Id. Qualität/Quality/Calid. | €/Stück Pce./Pce./Pza. |
|---------------------------------|--|------------------------------|----------|---------------------------------------|---------------------------|
| DKT-200 Trennen | Obermesser, links 330 x 75/65 x 12 | 5/M8 | 1,90 | 082.70/002F236 | 255,00 |
| | Obermesser, rechts 330 x 75/65 x 12 | 5/M8 | 1,90 | 082.70/003F236 | 255,00 |
| | Untermesser 360 x 20 x 12 | 6 zyl.vers. Langlöcher | 0,63 | 082.61/123F236 | 235,00 |



DUPLO

| Maschinen-Typ Type/Type/Tipo | Abmessungen in mm Size/Dimension/Tamaño | Löcher/Holes Trous/Huecos | ⚖️ kg | FASSCO-Id. Qualität/Quality/Calid. | €/Stück Pce./Pce./Pza. |
|---|--|------------------------------|----------|---------------------------------------|---------------------------|
| DK/DKT-220 Stanzen V-Fase Luftlöcher Punch cut V-shape air holes | Obermesser 303 x 73,5/61,5/50,5 x 6 | 4/M8 4/Ø2,5 | 0,80 | 082.60/206F236 | 333,00 |
| | Untermesser 360 x 20 x 12 | 6 zyl.vers. Langlöcher | 0,63 | 082.61/123F236 | 235,00 |



EBA/KRUG&PRIESTER (EHINGER)

| Maschinen-Typ Type/Type/Tipo | Abmessungen in mm Size/Dimension/Tamaño | Löcher/Holes Trous/Huecos | ⚖️ kg | FASSCO-Id. Qualität/Quality/Calid. | €/Stück Pce./Pce./Pza. |
|--|--|------------------------------|----------|---------------------------------------|---------------------------|
| EBA Multicut 4/360 T/U | 418 x 50 x 6 (4 230 4 011) | 6/M6 | 0,77 | 037.01F220 | 130,00 |
| EBA Multicut 435 A/ E/ M IDEAL 4205/15 | 487 x 39 x 6 (9000 121) | 5/M6 | 0,65 | 015.15F220 | 110,00 |
| EBA Multicut 4/430E/EP/430M IDEAL 4305/15 | 487 x 39 x 6 (9000 120.3) | 5/M6 | 0,65 | 015.13F220 | 110,00 |
| EBA Multicut 4/460 T/U | 518 x 50 x 6 (4 234 4 009) | 7/M6 | 0,97 | 037.02F220 | 144,00 |
| EBA Multicut 480A | 570 x 50 x 6 | 5/M6 | 1,07 | 037.10F220 | 149,00 |
| EBA Multicut 8/480E 480EP 485EP | 580 x 90 x 10 (4 250 4 017) (4 250 4 044) | 10/M10 | 3,50 | 037.05F220 | 150,00 |
| | | | | 037.05F3000 | 207,00 |
| EBA Multicut 10/520 10/550 E/EP/LT 10/550 CNC 551-06 /LT IDEAL 5560 | 660 x 104 x 9,8 (4 244 4 005) (4 244 4 036) (3 244 4 015) | 10/M10 | 4,55 | 037.04F220 | 186,00 |
| | | | | 037.04F3000 | 225,00 |
| EBA Multicut 10/660 10/660 E | 784 x 104 x 9,8 (4 265 4 006) (4 265 4 020) | 10/M10 | 5,50 | 037.07F220 | 225,00 |
| | | | | 037.07F3000 | 295,00 |
| EBA 721 LT 721-05 LT 721-06 LT IDEAL 7228 | 840 x 100 x 10 (9000 141) | 6/M10 | 5,50 | 015.09F220 | 210,00 |
| | | | | 015.09F3000 | 287,00 |
| EBA Multicut 10/710 10/720 E /CNC | 870 x 104 x 9,9 (4 239 4 020) (4 239 4 022) | 12/M10 | 6,15 | 037.03F220 | 240,00 |
| | | 2/M8 | | 037.03F3000 | 325,00 |

EUROCUTTER (MZE)

(DIPLOMAT / O-SUNG HYDRAULIK)

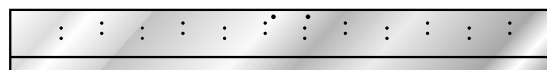

| Maschinen-Typ Type/Type/Tipo | Abmessungen in mm Size/Dimension/Tamaño | Löcher/Holes Trous/Huecos | ⚖ kg | FASSCO-Id. Qualität/Quality/Calid. | €/Stück Pce./Pce./Pza. |
|---------------------------------|--|------------------------------|---------|---------------------------------------|---------------------------|
| 780 | 960 x 110 x 11,7 | 18/M10 +MWE | 8,30 | 105.05F220 | * |
| | | | | 105.05F3000 | * |
| 920 | 1095 x 115 x 11,7 | 22/M10 +MWE | 10,05 | 105.09F220 | * |
| | | | | 105.09F3000 | * |
| 1016 | 1260 x 140 x 13,75 | 18- 1/2"W | 16,80 | 118.01F220 | * |
| | | | | 118.01F3000 | * |
| 1016 | 1260 x 160 x 13,75 | 24/M12 | 19,30 | 105.02F220 | * |
| | | | | 105.02F3000 | * |
| 1160 | 1390 x 160 x 13,75 | 26/M12 | 21,35 | 105.03F220 | * |
| | | | | 105.03F3000 | * |
| 1160 Neu/new | 1390 x 160 x 13,75 (Rü: 24-42/29-47) | 26/M12 | 21,35 | 105.13F220 | * |
| | | | | 105.13F3000 | * |
| 1320 | 1560 x 160 x 13,75 | 30/M12 | 23,90 | 105.04F220 | * |
| | | | | 105.04F3000 | * |
| 1320 Neu/new | 1560 x 160 x 13,75 (Rü: 24-42/29-47) | 30/M12 | 23,90 | 105.14F220 | * |
| | | | | 105.14F3000 | * |
| 1380 | 1605 x 160 x 13,75 | 30/M12 +MWE | 24,50 | 105.07F220 | * |
| | | | | 105.07F3000 | * |
| 2600 | 2840 x 140 x 13,75 (428-26-00) | 56/M12 +MWE | 37,50 | 105.06F220 | * |
| | | | | 105.06F3000 | * |
| 2600 | 2840 x 160 x 13,75 (428-26-02) | 56/M12 +MWE | 43,10 | 105.08F220 | * |
| | | | | 105.08F3000 | * |
| 2800 | 3040 x 160 x 13,75 | 60/M12 +MWE | 46,20 | 105.11F220 | * |
| | | | | 105.11F3000 | * |

* Für alle EUROCUTTER-Typen ist eine Zeichnung erforderlich. / * For all EUROCUTTER-types a drawing is required.

| Maschinen-Typ Type/Type/Tipo | Abmessungen in mm Size/Dimension/Tamaño | Löcher/Holes Trous/Huecos | ⚖ kg | FASSCO-Id. Qualität/Quality/Calid. | €/Stück Pce./Pce./Pza. |
|---------------------------------|--|------------------------------|---------|---------------------------------------|---------------------------|
| TM 28 TKT | Vordermesser 550 x 127 x 12,7 | 10/M10 | 5,35 | 105.90/001F220 | * |
| | | | | 105.90/001F3000 | * |
| | Seitenmesser, links 420 x 127 x 12,7 | 8/M10 | 4,10 | 105.90/002F220 | * |
| | | | | 105.90/002F3000 | * |
| | Seitenmesser, rechts 420 x 127 x 12,7 | 8/M10 | 4,10 | 105.90/003F220 | * |
| | | | | 105.90/003F3000 | * |
| €/Satz/Set/Jeu/Juego | | | | | |
| TM 28 TKT | kompletter Satz complete set | = 3 Messer = 3 knives | 13,55 | 105.90/300F220 | * |
| | | | | 105.90/300F3000 | * |

| Maschinen-Typ Type/Type/Tipo | Abmessungen in mm Size/Dimension/Tamaño | Löcher/Holes Trous/Huecos | ⚖ kg | FASSCO-Id. Qualität/Quality/Calid. | €/Stück Pce./Pce./Pza. |
|-----------------------------------|--|------------------------------|---------|---------------------------------------|---------------------------|
| TM 28 TKT Universal- Messer | Seitenmesser, links/rechts 420 x 127 x 12,7 | 16/M10 | 4,05 | 105.90/023F220 | * |
| | | | | 105.90/023F3000 | * |



FEIDA

(COOPER CCM, JUD, F.T.P.)

| Maschinen-Typ Type/Type/Tipo | Abmessungen in mm Size/Dimension/Tamaño | Löcher/Holes Trous/Huecos | △△ kg | FASSCO-Id. Qualität/Quality/Calid. | €/Stück Pce./Pce./Pza. |
|---------------------------------|--|------------------------------|----------|---------------------------------------|---------------------------|
| 43 430 C | 490 x 41 x 6 | 7/M5 | 0,80 | 013.07F220 | * |
| | | | | 013.07F3000 | * |
| 76 78 | 940 x 127 x 12,7 (78-01-07) | 16/M12 +MWE | 10,50 | 013.01F220 | * |
| | | | | 013.01F3000 | * |
| FD 78 | 970 x 127 x 12,7 (78-01-07a) | 16/M12 +MWE | 10,80 | 013.06F220 | * |
| | | | | 013.06F3000 | * |
| FD 92 | 1080 x 127 x 12,7 (92-01-05) | 18/M12 +MWE | 12,05 | 013.02F220 | * |
| | | | | 013.02F3000 | * |
| FD 115 | 1390 x 160 x 12,7 (115-01-21) | 22/M12 +MWE | 19,60 | 013.03F220 | * |
| | | | | 013.03F3000 | * |
| FD 137 | 1605 x 160 x 12,7 (137-01-3) | 26/M12 +MWE | 22,65 | 013.04F220 | * |
| | | | | 013.04F3000 | * |
| FD 155 | 1790 x 160 x 12,7 (155-01-23) | 28/M12 +MWE | 25,25 | 013.05F220 | * |
| | | | | 013.05F3000 | * |
| FD 176 | 1905 x 160 x 13,75 | 36/M12 +MWE | 29,20 | 013.08F220 | * |
| | | | | 013.08F3000 | * |
| FD 220 QZK 2200 | 2460 x 160 x 13,75 | 48/M12 +MWE | 37,70 | 013.09F220 | * |
| | | | | 013.09F3000 | * |



F.L.

| Maschinen-Typ Type/Type/Tipo | Abmessungen in mm Size/Dimension/Tamaño | Löcher/Holes Trous/Huecos | △△ kg | FASSCO-Id. Qualität/Quality/Calid. | €/Stück Pce./Pce./Pza. |
|---------------------------------|--|------------------------------|----------|---------------------------------------|---------------------------|
| 54 | 620 x 112 x 9 | 7/M8 | 4,30 | 030.18F220 | * |
| | | | | 030.18F3000 | * |
| 58 alt/old | 730 x 100 x 10 | 10/M12 | 5,05 | 030.16F220 | * |
| | | | | 030.16F3000 | * |
| 58 neu/new | 770 x 100 x 10 | 10/M12 | 5,30 | 030.19F220 | * |
| | | | | 030.19F3000 | * |
| 67 | 840 x 100 x 8 | 16/M10 | 4,65 | 030.17F220 | * |
| | | | | 030.17F3000 | * |
| 72 | 912 x 115 x 10 | 24/M14x1,5 | 7,20 | 030.14F220 | * |
| | | | | 030.14F3000 | * |
| 76 GW | 900 x 100 x 10 | 12/M12 | 6,05 | 004.20F220 | * |
| | | | | 004.20F3000 | * |
| 82 AB 82 D/C/S | 1000 x 130 x 10 | 16/M10 | 9,00 | 030.01F220 | * |
| | | | | 030.01F3000 | * |
| 92 (alt) | 1080 x 130 x 12 | 18/M12 | 11,70 | 030.02F220 | * |
| | | | | 030.02F3000 | * |
| 92 (neu) | 1060 x 125 x 12 | 18/M12 | 11,05 | 030.13F220 | * |
| | | | | 030.13F3000 | * |
| 106 C/E/L/D 106 N | 1240 x 130 x 12 | 20/M10 | 13,40 | 030.03F220 | * |
| | | | | 030.03F3000 | * |

F.L.



| Maschinen-Typ Type/Type/Tipo | Abmessungen in mm Size/Dimension/Tamaño | Löcher/Holes Trous/Huecos | △△ kg | FASSCO-Id. Qualität/Quality/Calid. | €/Stück Pce./Pce./Pza. |
|---------------------------------|--|------------------------------|----------|---------------------------------------|---------------------------|
| 115 CL (alt) | 1370 x 130 x 13 | 22/M12 | 16,05 | 030.04F220 | * |
| | | | | 030.04F3000 | * |
| 115 (10/87) 118 | 1400 x 140 x 14 | 22/M12 | 19,05 | 030.15F220 | * |
| | | | | 030.15F3000 | * |
| 125 C 125 D | 1488 x 130 x 12 | 24/M10 | 16,10 | 030.05F220 | * |
| | | | | 030.05F3000 | * |
| 135 C 135 E | 1580 x 150 x 14 | 26/M12 | 23,05 | 030.06F220 | * |
| | | | | 030.06F3000 | * |
| 150 CL 150 B | 1825 x 150 x 15 | 28/M12 | 28,55 | 030.07F220 | * |
| | | | | 030.07F3000 | * |
| 165 I/D/F 165 C | 1945 x 150 x 15 | 32/M12 | 30,40 | 030.08F220 | * |
| | | | | 030.08F3000 | * |
| 185 | 2170 x 180 x 18 | 34/M14 | 48,95 | 030.09F220 | * |
| | | | | 030.09F3000 | * |
| 200 P | 2350 x 200 x 20 | 36/M14 | 65,45 | 030.10F220 | * |
| | | | | 030.10F3000 | * |
| 225 CL 225 P | 2600 x 200 x 20 | 40/M14 | 72,45 | 030.11F220 | * |
| | | | | 030.11F3000 | * |

FERAG

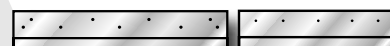

| Maschinen-Typ Type/Type/Tipo | Abmessungen in mm Size/Dimension/Tamaño | Löcher/Holes Trous/Huecos | △△ kg | FASSCO-Id. Qualität/Quality/Calid. | €/Stück Pce./Pce./Pza. |
|---------------------------------|---|------------------------------|----------|---------------------------------------|---------------------------|
| SNT-U | Messer, Front 38.02.2821 406 x 60 x 11,5 | 5/M8 | 2,10 | 104.91/001F4010 | * |
| | | | | 104.91/001F8000 | * |
| | Messer, Kopf - Fuß 38.02.8370 530 x 60 x 8,2 | 6/M8 | 1,80 | 104.91/023F4010 | * |
| | | | | 104.91/023F8000 | * |
| | Gegenmesser, Front 38.02.0262 530 x 25 x 12 | 4/M8 | 1,25 | 104.91/101F4010 | * |
| | | | | 104.91/101F8000 | * |
| | Gegenmesser, Kopf - Fuß 38.02.2464 412 x 25 x 12 | 5/M8 | 0,95 | 104.91/123F4010 | * |
| | | | | 104.91/123F8000 | * |

Für alle FERAG-Typen ist eine Zeichnung erforderlich.
For all FERAG-types a drawing is required.

| Maschinen-Typ Type/Type/Tipo | Abmessungen in mm Size/Dimension/Tamaño | Löcher/Holes Trous/Huecos | △△ kg | FASSCO-Id. Qualität/Quality/Calid. | €/Stück Pce./Pce./Pza. |
|---------------------------------|--|------------------------------|----------|---------------------------------------|---------------------------|
| | Gegenmesser, links 38.01.0217 385 x 25 x 12 | 5/M8 | 0,90 | 104.90/102F4010 | * |
| | | | | 104.90/102F8000 | * |
| | Gegenmesser, rechts 38.01.0215 385 x 25 x 12 | 5/M8 | 0,90 | 104.90/103F4010 | * |
| | | | | 104.90/103F8000 | * |

Für alle FERAG-Typen ist eine Zeichnung erforderlich.
For all FERAG-types a drawing is required.



FERAG

| Maschinen-Typ Type/Type/Tipo | Abmessungen in mm Size/Dimension/Tamaño | Löcher/Holes Trous/Huecos | kg | FASSCO-Id. Qualität/Quality/Calid. | €/Stück Pce./Pce./Pza. |
|---------------------------------|---|------------------------------|------|---------------------------------------|---------------------------|
| SNT-35/42/48 SNT 480 | Messer, Front 38.01.1262 540 x 60 x 8,3 | 9/M8 | 1,80 | 104.90/001F4010 | * |
| | | | | 104.90/001F8000 | * |
| | Messer, Kopf – Fuß 38.01.0219 390 x 60 x 11,5 | 5/M8 | 1,85 | 104.90/023F4010 | * |
| | | | | 104.90/023F8000 | * |
| | Gegenmesser, Front 38.01.0254 530 x 25 x 12 | 4/M8 | 1,25 | 104.90/101F4010 | * |
| | | | | 104.90/101F8000 | * |
| | Gegenmesser, rechts Fuß 38.01.6168 385 x 25 x 12 | 5/M8 | 0,90 | 104.90/104F4010 | * |
| | | | | 104.90/104F8000 | * |
| | Gegenmesser, links Kopf 38.01.6166 385 x 25 x 12 | 5/M8 | 0,90 | 104.90/105F4010 | * |
| | | | | 104.90/105F8000 | * |

Für alle FERAG-Typen ist eine Zeichnung erforderlich.
For all FERAG-types a drawing is required.



FURNIVAL

| Maschinen-Typ Type/Type/Tipo | Abmessungen in mm Size/Dimension/Tamaño | Löcher/Holes Trous/Huecos | kg | FASSCO-Id. Qualität/Quality/Calid. | €/Stück Pce./Pce./Pza. |
|---------------------------------|--|------------------------------|-------|---------------------------------------|---------------------------|
| 35" | 1098,5 x 127 x 15,7 43.25" x 5" x .619" | 26 5/8"W | 14,68 | 097.01F220 | * |
| | | | | 097.01F3000 | * |
| 42" (5") | 1346 x 127 x 15,7 53" x 5" x .619" | 32 5/8"W 2/Ø9,5 | 18,05 | 097.03F220 | * |
| | | | | 097.03F3000 | * |
| 42" (5.75") | 1346 x 146 x 15,7 53" x 5.75" x .619" | 32 5/8"W 2/Ø9,5 | 20,75 | 097.13F220 | * |
| | | | | 097.13F3000 | * |
| 48" (5") | 1498,5 x 127 x 15,7 59" x 5" x .619" | 36 5/8"W 2/Ø9,5 | 20,03 | 097.04F220 | * |
| | | | | 097.04F3000 | * |
| 48" (5.75") | 1498,5 x 146 x 15,7 59" x 5.75" x .619" | 36 5/8"W 2/Ø9,5 | 23,10 | 097.14F220 | * |
| | | | | 097.14F3000 | * |
| 52" (5") | 1600 x 127 x 15,7 63" x 5" x .619" | 40 5/8"W 2/Ø9,5 | 21,45 | 097.05F220 | * |
| | | | | 097.05F3000 | * |
| 52" (5.75") | 1600 x 146 x 15,7 63" x 5.75" x .619" | 40 5/8"W 2/Ø9,5 | 24,70 | 097.15F220 | * |
| | | | | 097.15F3000 | * |
| 64" | 1905 x 146 x 15,7 75" x 5.75" x .619" | 46 5/8"W | 29,35 | 097.06F220 | * |
| | | | | 097.06F3000 | * |
| 77" | 2235 x 146 x 15,7 88" x 5.75" x .619" | 44 5/8"W | 34,40 | 097.07F220 | * |
| | | | | 097.07F3000 | * |

GOLDING

| Maschinen-Typ Type/Type/Tipo | Abmessungen in mm Size/Dimension/Tamaño | Löcher/Holes Trous/Huecos |  kg | FASSCO-Id. Qualität/Quality/Calid. | €/Stück Pce./Pce./Pza. |
|---------------------------------|--|------------------------------|---|---------------------------------------|---------------------------|
| 26" | 787,4 x 101,6 x 9,35 31" x 4" x .368" | 10 3/8-16NC | 5,10 | 132.01F220 | * |
| | | | | 132.01F3000 | * |

GOODHALE



| Maschinen-Typ Type/Type/Tipo | Abmessungen in mm Size/Dimension/Tamaño | Löcher/Holes Trous/Huecos |  kg | FASSCO-Id. Qualität/Quality/Calid. | €/Stück Pce./Pce./Pza. |
|---------------------------------|--|------------------------------|---|---------------------------------------|---------------------------|
| 20" Powermatic | 650 x 90 x 7 mm | 6/M8 | 2,80 | 077.03F220 | * |
| | | | | 077.03F3000 | * |
| 58 (FL) | 730 x 100 x 10 | 10/M12 | 5,05 | 030.16F220 | * |
| | | | | 030.16F3000 | * |
| 25" | 762 x 101,6 x 7,93 30" x 4" x .3125" | 4 3/8"W | 4,25 | 077.01F220 | * |
| | | | | 077.01F3000 | * |
| 25" 26" | 787 x 101,6 x 7,93 31" x 4" x .3125" | 4 3/8"W | 4,35 | 077.02F220 | * |
| | | | | 077.02F3000 | * |
| 76 30" | 900 x 100 x 10 | 12/M12 | 6,05 | 004.20F220 | * |
| | | | | 004.20F3000 | * |

GRAFMASZ



| Maschinen-Typ Type/Type/Tipo | Abmessungen in mm Size/Dimension/Tamaño | Löcher/Holes Trous/Huecos |  kg | FASSCO-Id. Qualität/Quality/Calid. | €/Stück Pce./Pce./Pza. |
|---------------------------------|--|------------------------------|---|---------------------------------------|---------------------------|
| G53 | 608 x 100 x 9,9 | 5/M10 | 4,20 | 147.01F220 | * |
| | | | | 147.01F3000 | * |
| G73 Stapelhöhe 80 | 822 x 100 x 9,9 | 12/M10 | 5,70 | 147.02F220 | * |
| | | | | 147.02F3000 | * |
| G73H Stapelhöhe 100 | 844 x 100 x 9,9 | 12/M10 | 5,80 | 147.03F220 | * |
| | | | | 147.03F3000 | * |

GRAPHOPRESS

| Maschinen-Typ Type/Type/Tipo | Abmessungen in mm Size/Dimension/Tamaño | Löcher/Holes Trous/Huecos |  kg | FASSCO-Id. Qualität/Quality/Calid. | €/Stück Pce./Pce./Pza. |
|---------------------------------|--|------------------------------|---|---------------------------------------|---------------------------|
| GR 480PX | 560 x 76 x 9 | 10/M8 | 2,60 | 153.01F220 | * |
| | | | | 153.01F3000 | * |
| GR-550PX | 650 x 80 x 9 | 12/M8 | 3,20 | 153.03F220 | * |
| | | | | 153.03F3000 | * |
| GR-550PX | 750 x 76 x 9 | 14/M8 | 3,50 | 153.04F220 | * |
| | | | | 153.04F3000 | * |
| GR-670HP | 755 x 80 x 10 | 14/M10 | 4,30 | 153.02F220 | * |
| | | | | 153.02F3000 | * |



GUARANI

| Maschinen-Typ Type/Type/Tipo | Abmessungen in mm Size/Dimension/Tamaño | Löcher/Holes Trous/Huecos | kg | FASSCO-Id. Qualität/Quality/Calid. | €/Stück Pce./Pce./Pza. |
|---------------------------------|--|------------------------------|-------|---------------------------------------|---------------------------|
| 82 HC/HCE/SMC | 1040 x 100 x 10 | 8/M10 | 7,20 | 032.01F220 | * |
| | | | | 032.01F3000 | * |
| 120 HSS/SMC | 1480 x 160 x 14 | 26/M12 | 23,05 | 032.02F220 | * |
| | | | | 032.02F3000 | * |
| 155 SMC | 1780 x 160 x 14 | 32/M12 | 27,70 | 032.05F220 | * |
| | | | | 032.05F3000 | * |

Für alle Typen ist eine Zeichnung erforderlich.
For all types a drawing is required.

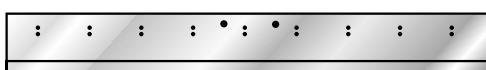

GUO WANG

(VEGA / DONIX)

| Maschinen-Typ Type/Type/Tipo | Abmessungen in mm Size/Dimension/Tamaño | Löcher/Holes Trous/Huecos | kg | FASSCO-Id. Qualität/Quality/Calid. | €/Stück Pce./Pce./Pza. |
|---------------------------------|--|------------------------------|-------|---------------------------------------|---------------------------|
| 67ET 670 | 780 x 103 x 10 (67-0209) | 14/M10 | 5,50 | 137.08F220 | * |
| | | | | 137.08F3000 | * |
| 780 | 960 x 127 x 12,7 (780-5A) | 16/M12 +MWE | 10,55 | 137.01F220 | * |
| | | | | 137.01F3000 | * |
| K80 DONIX 80 | 980 x 127 x 12,7 (K-80-0104-36) | 18/M10 +MWE | 10,75 | 137.09F220 | * |
| | | | | 137.09F3000 | * |
| 920 | 1100 x 127 x 12,7 (5021) | 18/M12 +MWE (406/12) | 12,10 | 137.05F220 | * |
| | | | | 137.05F3000 | * |
| K92 DONIX 92 | 1100 x 127 x 12,7 (K-92-0104-36) | 18/M12 +MWE (408/13) | 12,10 | 137.10F220 | * |
| | | | | 137.10F3000 | * |
| 1150 | 1390 x 160 x 13,75 (5021) (id. 007.24) | 24/M12 +MWE (Ø34) | 21,35 | 137.03F220 | * |
| | | | | 137.03F3000 | * |
| 1150 | 1390 x 160 x 13,75 (1150-5002) | 24/M12 +MWE (U26) | 21,35 | 150.61F220 | * |
| | | | | 150.61F3000 | * |
| 1370 | 1605 x 160 x 13,75 (2001) (id. 007.27) | 30/M12 +MWE | 24,50 | 137.04F220 | * |
| | | | | 137.04F3000 | * |
| 1370 | 1605 x 160 x 13,75 (SQZ137.1-12) (id. 137.04 + 4/M6) | 30/M12 +MWE 4/M6 | 24,50 | 137.06F220 | * |
| | | | | 137.06F3000 | * |

HAMOSI-WEBER

| Maschinen-Typ Type/Type/Tipo | Abmessungen in mm Size/Dimension/Tamaño | Löcher/Holes Trous/Huecos | kg | FASSCO-Id. Qualität/Quality/Calid. | €/Stück Pce./Pce./Pza. |
|---|--|------------------------------|------|---------------------------------------|---------------------------|
| APMS 600 Stanzen V-Fase Punch cut V-shape | Obermesser 220x60/57x6 | 8 Langlöcher 2/M5 | 0,50 | 141.60/006F-236 | * |

HEIDELBERG

(Heidelberg Finishing / Brehmer – Stahl)



| Maschinen-Typ Type/Type/Tipo | Abmessungen in mm Size/Dimension/Tamaño | Löcher/Holes Trous/Huecos | △ ⁺ △ ₋ kg | FASSCO-Id. Qualität/Quality/Calid. | €/Stück Pce./Pce./Pza. |
|---|--|------------------------------|-------------------------------------|---------------------------------------|---------------------------|
| Stitchmaster ST 100 | Vordermesser, oben 083F242x062x00x11 362 x 76,2 x 9,5 | 5/M12 4/M5 | 1,65 | 083.91/001F236 | 131,00 |
| | | | | 083.91/001F3000 | 159,00 |
| | Seitenmesser, oben links 083F242x062x00x11 362 x 76,2 x 9,5 | 5/M12 4/M5 | 1,65 | 083.91/001F236 | 131,00 |
| | | | | 083.91/001F3000 | 159,00 |
| | Seitenmesser, oben rechts 083F242x062x00x11 362 x 76,2 x 9,5 | 5/M12 4/M5 | 1,65 | 083.91/001F236 | 131,00 |
| | | | | 083.91/001F3000 | 159,00 |
| | Vordermesser, unten 083F242x061x00x11 406,5 x 24,7 x 12,7 | 5 zyl.vers. Langlöcher | 0,83 | 083.91/101F236 | 111,00 |
| | Seitenmesser, unten links 083F242x061x00x11 406,5 x 24,7 x 12,7 | 5 zyl.vers. Langlöcher | 0,83 | 083.91/101F236 | 111,00 |
| | Seitenmesser, unten rechts 083F242x061x00x11 406,5 x 24,7 x 12,7 | 5 zyl.vers. Langlöcher | 0,83 | 083.91/101F236 | 111,00 |
| €/Satz/Set/Jeu/Juego | | | | | |
| Stitchmaster ST 100 | Satz Obermesser Set Upper knives | = 3 Messer = 3 knives | 4,95 | 083.91/300F236 | 393,00 |
| | Satz Obermesser Set Upper knives | = 3 Messer = 3 knives | 4,95 | 083.91/300F3000 | 477,00 |
| | Satz Untermesser Set Bottom knives | = 3 Messer = 3 knives | 2,49 | 083.91/303F236 | 333,00 |
| Maschinen-Typ Type/Type/Tipo | Abmessungen in mm Size/Dimension/Tamaño | Löcher/Holes Trous/Huecos | △ ⁺ △ ₋ kg | FASSCO-Id. Qualität/Quality/Calid. | €/Stück Pce./Pce./Pza. |
| Stitchmaster ST 100.2 verlängerter Frontbeschnitt extended front cut | Vordermesser, oben 083FFJ3220x491x02 390 x 76,2 x 9,5 | 5/M12 2/M5 | 1,75 | 083.91/011F236 | 145,00 |
| | | | | 083.91/011F3000 | 170,00 |
| | Seitenmesser, oben links 083F242x062x00x11 362 x 76,2 x 9,5 | 5/M12 4/M5 | 1,65 | 083.91/001F236 | 131,00 |
| | | | | 083.91/001F3000 | 159,00 |
| | Seitenmesser, oben rechts 083F242x062x00x11 362 x 76,2 x 9,5 | 5/M12 4/M5 | 1,65 | 083.91/001F236 | 131,00 |
| | | | | 083.91/001F3000 | 159,00 |
| | Vordermesser, unten 083FFJ3220x501x02 406,5 x 24,7 x 12,7 | 5 zyl.vers. Langlöcher | 0,83 | 083.91/111F236 | 113,00 |
| | Seitenmesser, unten links 083F242x061x00x11 406,5 x 24,7 x 12,7 | 5 zyl.vers. Langlöcher | 0,83 | 083.91/101F236 | 111,00 |
| | Seitenmesser, unten rechts 083F242x061x00x11 406,5 x 24,7 x 12,7 | 5 zyl.vers. Langlöcher | 0,83 | 083.91/101F236 | 111,00 |
| €/Satz/Set/Jeu/Juego | | | | | |
| Stitchmaster ST 100.2 | Satz Obermesser Set Upper knives | = 3 Messer = 3 knives | 5,05 | 083.91A/300F236 | 407,00 |
| | Satz Obermesser Set Upper knives | = 3 Messer = 3 knives | 5,05 | 083.91A/300F3000 | 488,00 |
| | Satz Untermesser Set Bottom knives | = 3 Messer = 3 knives | 2,49 | 083.91A/303F236 | 335,00 |



| Maschinen-Typ Type/Type/Tipo | Abmessungen in mm Size/Dimension/Tamaño | Löcher/Holes Trous/Huecos | △ kg | FASSCO-Id. Qualität/Quality/Calid. | €/Stück Pce./Pce./Pza. |
|--|---|------------------------------|----------------|---------------------------------------|---------------------------|
| Stitchmaster ST 300 altes Modell old Model | Vordermesser, oben 028F2140x073x00x11 540 x 76,2 x 9,5 | 5/M12 | 2,52 | 028.91/001F236 | 215,00 |
| | | 8/M5 | | 028.91/001F3000 | 251,00 |
| | Seitenmesser, oben links 028F2140x132x00x11 362 x 76,2 x 9,5 | 5/M12 | 1,68 | 028.91/023F236 | 146,00 |
| | | 4/M5 | | 028.91/023F3000 | 177,00 |
| | Seitenmesser, oben rechts 028F2140x132x00x11 362 x 76,2 x 9,5 | 5/M12 | 1,68 | 028.91/023F236 | 146,00 |
| | | 4/M5 | | 028.91/023F3000 | 177,00 |
| | Vordermesser, unten 028F2140x067x00x11 560 x 24,7 x 12,7 | 5 zyl.vers. Langlöcher | 1,18 | 028.91/101F236 | 147,00 |
| Seitenmesser, unten links 028F2140x110x00x11 407 x 24,7 x 12,7 | 5 zyl.vers. Langlöcher | 0,82 | 028.91/123F236 | 124,00 | |
| Seitenmesser, unten rechts 028F2140x110x00x11 407 x 24,7 x 12,7 | 5 zyl.vers. Langlöcher | 0,82 | 028.91/123F236 | 124,00 | |
| €/Satz/Set/Jeu/Juego | | | | | |
| Stitchmaster ST 300 altes Modell old Model | Satz Obermesser Set Upper knives | = 3 Messer = 3 knives | 5,88 | 028.91/300F236 | 507,00 |
| | Satz Obermesser Set Upper knives | = 3 Messer = 3 knives | 5,88 | 028.91/300F3000 | 605,00 |
| | Satz Untermesser Set Bottom knives | = 3 Messer = 3 knives | 2,82 | 028.91/303F236 | 395,00 |
| Maschinen-Typ Type/Type/Tipo | Abmessungen in mm Size/Dimension/Tamaño | Löcher/Holes Trous/Huecos | △ kg | FASSCO-Id. Qualität/Quality/Calid. | €/Stück Pce./Pce./Pza. |
| Stitchmaster ST 250 ST 270 ST 300 (ab 1998) | Vordermesser, oben 028F2140x040x00x11x01 560 x 86 x 8 | 5/M12 | 2,59 | 028.93/001F236 | 185,00 |
| | | 2/M5 | | 028.93/001F3000 | 199,00 |
| | Seitenmesser, oben links 028F2140x038x00x11x01 382 x 86 x 8 | 5/M12 | 1,75 | 028.93/023F236 | 132,00 |
| | | 2/M5 | | 028.93/023F3000 | 146,00 |
| | Seitenmesser, oben rechts 028F2140x038x00x11x01 382 x 86 x 8 | 5/M12 | 1,75 | 028.93/023F236 | 132,00 |
| | | 2/M5 | | 028.93/023F3000 | 146,00 |
| | Vordermesser, unten 028F2140x067x00x11x05 560 x 25,7 x 12,7 | 5 zyl. vers. Langlöcher | 1,24 | 028.93/101F236 | 128,00 |
| Seitenmesser, unten links 028F2140x110x00x11x05 407 x 25,7 x 12,7 | 5 zyl. vers. Langlöcher | 0,86 | 028.93/123F236 | 108,00 | |
| Seitenmesser, unten rechts 028F2140x110x00x11x05 407 x 25,7 x 12,7 | 5 zyl. vers. Langlöcher | 0,86 | 028.93/123F236 | 108,00 | |
| €/Satz/Set/Jeu/Juego | | | | | |
| Stitchmaster (ab 1998) ST 250 ST 300 | Satz Obermesser Set Upper knives | = 3 Messer = 3 knives | 6,09 | 028.93/300F236 | 449,00 |
| | Satz Obermesser Set Upper knives | = 3 Messer = 3 knives | 6,09 | 028.93/300F3000 | 491,00 |
| | Satz Untermesser Set Bottom knives | = 3 Messer = 3 knives | 2,96 | 028.93/303F236 | 344,00 |

HEIDELBERG

(Heidelberg Finishing / Brehmer – Stahl)



| Maschinen-Typ Type/Type/Tipo | Abmessungen in mm Size/Dimension/Tamaño | Löcher/Holes Trous/Huecos | ⚖️ kg | FASSCO-Id. Qualität/Quality/Calid. | €/Stück Pce./Pce./Pza. |
|--|---|------------------------------|----------------|---------------------------------------|---------------------------|
| Stitchmaster ST 350 ST 400 | Vordermesser, oben 028F2160x307x00x01 560 x 95 x 8 | 5/M8 2/M5 | 2,94 | 028.94/001F236 | 183,00 |
| | | | | 028.94/001F3000 | 199,00 |
| | Seitenmesser, oben links 028F2160x308x00x01 382 x 95 x 8 | 5/M8 2/M5 | 1,98 | 028.94/023F236 | 133,00 |
| | | | | 028.94/023F3000 | 145,00 |
| | Seitenmesser, oben rechts 028F2160x308x00x01 382 x 95 x 8 | 5/M8 2/M5 | 1,98 | 028.94/023F236 | 133,00 |
| | | | | 028.94/023F3000 | 145,00 |
| | Vordermesser, unten 028F2140x067x00x11x05 560 x 25,7 x 12,7 | 5 zyl. vers. Langlöcher | 1,24 | 028.93/101F236 | 128,00 |
| Seitenmesser, unten links 028F2140x110x00x11x05 407 x 25,7 x 12,7 | 5 zyl. vers. Langlöcher | 0,86 | 028.93/123F236 | 108,00 | |
| Seitenmesser, unten rechts 028F2140x110x00x11x05 407 x 25,7 x 12,7 | 5 zyl. vers. Langlöcher | 0,86 | 028.93/123F236 | 108,00 | |
| €/Satz/Set/Jeu/Juego | | | | | |
| Stitchmaster ST 350 ST 400 | Satz Obermesser Set Upper knives | = 3 Messer = 3 knives | 6,90 | 028.94/300F236 | 449,00 |
| | Satz Obermesser Set Upper knives | = 3 Messer = 3 knives | 6,90 | 028.94/300F3000 | 489,00 |
| | Satz Untermesser Set Bottom knives | = 3 Messer = 3 knives | 2,96 | 028.93/303F236 | 344,00 |
| Maschinen-Typ Type/Type/Tipo | Abmessungen in mm Size/Dimension/Tamaño | Löcher/Holes Trous/Huecos | ⚖️ kg | FASSCO-Id. Qualität/Quality/Calid. | €/Stück Pce./Pce./Pza. |
| Stitchmaster ST 350 ST 450 Sonderlänge Special length | Vordermesser, oben 028F2160x307x00x01 560 x 95 x 8 | 5/M8 2/M5 | 2,94 | 028.94/001F236 | 183,00 |
| | | | | 028.94/001F3000 | 199,00 |
| | Seitenmesser, oben links 028F2160x308x00x01 382 x 95 x 8 | 5/M8 2/M5 | 1,98 | 028.94/023F236 | 133,00 |
| | | | | 028.94/023F3000 | 145,00 |
| | Seitenmesser, oben rechts 028F2160x308x00x01 382 x 95 x 8 | 5/M8 2/M5 | 1,98 | 028.94/023F236 | 133,00 |
| | | | | 028.94/023F3000 | 145,00 |
| | Vordermesser, unten 028F2140x067x00x11x05 560 x 25,7 x 12,7 | 5 zyl. vers. Langlöcher | 1,24 | 028.93/101F236 | 128,00 |
| Seitenmesser, unten links 028FFJ 1221171x01 397 x 25,7 x 12,7 | 5 zyl. vers. Langlöcher | 0,84 | 028.95/123F236 | 108,00 | |
| Seitenmesser, unten rechts 028FFJ 1221171x01 397 x 25,7 x 12,7 | 5 zyl. vers. Langlöcher | 0,84 | 028.95/123F236 | 108,00 | |
| €/Satz/Set/Jeu/Juego | | | | | |
| Stitchmaster ST 350 ST 450 Sonderlänge Special length | Satz Obermesser Set Upper knives | = 3 Messer = 3 knives | 6,90 | 028.94/300F236 | 449,00 |
| | Satz Obermesser Set Upper knives | = 3 Messer = 3 knives | 6,90 | 028.94/300F3000 | 489,00 |
| | Satz Untermesser Set Bottom knives | = 3 Messer = 3 knives | 2,92 | 028.95/303F236 | 344,00 |



HEIDELBERG

(Heidelberg Finishing / Brehmer – Stahl)

| Maschinen-Typ Type/Type/Tipo | Abmessungen in mm Size/Dimension/Tamaño | Löcher/Holes Trous/Huecos | △ kg | FASSCO-Id. Qualität/Quality/Calid. | €/Stück Pce./Pce./Pza. |
|--|---|--------------------------------|---------|---------------------------------------|---------------------------|
| Stitchmaster ST/TM 100/ 250/300/400 Trennen Fase 22° Split cut Bevel 22° | Obermesser 028F2141x308x00x11 362 x 76 x 9,5 | 5 Langlöcher 2/M12 2//M5 | 1,83 | 028.70/009F236 | 241,00 |
| | Untermesser 028F2140x110x00x11x05 407 x 25,7 x 12,7 | 5 zyl.vers. Langlöcher | 0,86 | 028.93/123F236 | 108,00 |

| Maschinen-Typ Type/Type/Tipo | Abmessungen in mm Size/Dimension/Tamaño | Löcher/Holes Trous/Huecos | △ kg | FASSCO-Id. Qualität/Quality/Calid. | €/Stück Pce./Pce./Pza. |
|--|---|--|---------|---------------------------------------|---------------------------|
| Stitchmaster ST/SM 100/ 250/300 Stanzen V-Fase mit Luft Punch cut V-Shape with Air | Obermesser 028FSM300x4 362 x 76 x 4 | 5 Langlöcher 2/M12 (ohne Luftl.) | 0,78 | 028.60/004F236 | 240,00 |
| | Obermesser 028FSM300x5 362 x 76 x 5 | 5 Langlöcher 2/M12 (ohne Luftl.) | 0,96 | 028.60/005F236 | 240,00 |
| | Obermesser 028FSM300x6/L 028F2140x878x00x11 362 x 76 x 6 | 5 Langlöcher 2/M12, 6/M5 4 Luftlö. 3 Ø | 1,16 | 028.60/206F236 | 246,00 |
| | Obermesser 028FSM300x8/L 028F2140x888x00x11 362 x 76 x 8 | 5 Langlöcher 2/M12, 6/M5 4 Luftlö. 3 Ø | 1,54 | 028.60/208F236 | 286,00 |
| | Obermesser 028FSM300x9 362 x 76 x 9 | 5 Langlöcher 2/M12, 6/M5 4 Luftlö. 3 Ø | 1,73 | 028.60/209F236 | 290,00 |
| | Obermesser 028FSM300x10/L 362 x 76 x 10 | 5 Langlöcher 2/M12, 6/M5 4 Luftlö. 3 Ø | 1,87 | 028.60/210F236 | 290,00 |
| | Obermesser 028FSM300x12/L 362 x 76 x 12 | 5 Langlöcher 2/M12, 6/M5 4 Luftlö. 3 Ø | 2,24 | 028.60/212F236 | 311,00 |
| | Untermesser, links 028F2140x110x00x11x05 407 x 25,7 x 12,7 | 5 zyl.vers. Langlöcher | 0,86 | 028.93/123F236 | 108,00 |
| | Untermesser, rechts 028F2140x110x00x11x05 407 x 25,7 x 12,7 | 5 zyl.vers. Langlöcher | 0,86 | 028.93/123F236 | 108,00 |

HEIDELBERG

(Heidelberg Finishing / Brehmer – Stahl)



| Maschinen-Typ Type/Type/Tipo | Abmessungen in mm Size/Dimension/Tamaño | Löcher/Holes Trous/Huecos | ⚖️ kg | FASSCO-Id. Qualität/Quality/Calid. | €/Stück Pce./Pce./Pza. |
|--|---|---|----------|---------------------------------------|---------------------------|
| Stitchmaster ST/SM 400/450 Stanzen V-Fase mit Luft Punch cut V-Shape with Air | Obermesser 028FSM300x4 362 x 76 x 4 | 5 Langlöcher 2/M12 (ohne Luftlö.) | 0,78 | 028.60/004F236 | 240,00 |
| | Obermesser 028FSM300x5 362 x 76 x 5 | 5 Langlöcher 2/M12 (ohne Luftlö.) | 0,96 | 028.60/005F236 | 240,00 |
| | Obermesser 028FSM300x6/L 2140-878-00-11 362 x 76 x 6 | 5 Langlöcher 2/M12, 6/M5 4 Luftlö. 3Ø | 1,16 | 028.60/206F236 | 246,00 |
| | Obermesser 028FSM300x8/L 2140-888-00-11 362 x 76 x 8 | 5 Langlöcher 2/M12, 6/M5 4 Luftlö. 3Ø | 1,54 | 028.60/208F236 | 286,00 |
| | Obermesser 028FSM300x10/L 362 x 76 x 10 | 5 Langlöcher 2/M12, 6/M5 4 Luftlö. 3Ø | 1,87 | 028.60/210F236 | 290,00 |
| | Obermesser 028FSM300x12/L 362 x 76 x 12 | 5 Langlöcher 2/M12, 6/M5 4 Luftlö. 3Ø | 2,24 | 028.60/212F236 | 311,00 |
| | Untermesser, links 407 x 20 x 12,7 | 5 zyl.vers. Langlöcher | 0,63 | 028.71/123F236 | 112,00 |
| | Untermesser, rechts 407 x 20 x 12,7 | 5 zyl.vers. Langlöcher | 0,63 | 028.71/123F236 | 112,00 |

HEIDELBERG

(Heidelberg Finishing / Brehmer – Stahl)



| Maschinen-Typ Type/Type/Tipo | Abmessungen in mm Size/Dimension/Tamaño | Löcher/Holes Trous/Huecos | ⚖️ kg | FASSCO-Id. Qualität/Quality/Calid. | €/Stück Pce./Pce./Pza. |
|---|--|------------------------------|----------|---------------------------------------|---------------------------|
| Dreischneider Three knife trim. Eurotrim ET900/ET1000 | Vordermesser 550 x 110 x 12 | 14/M10 | 5,00 | 121.91/001F220 | 211,00 |
| | | | | 121.91/001F3000 | 263,00 |
| | Seitenmesser, links 460 x 110 x 12 | 12/M10 | 4,20 | 121.91/023F220 | 188,00 |
| | | | | 121.91/023F3000 | 238,00 |
| | Seitenmesser, rechts 460 x 110 x 12 | 12/M10 | 4,20 | 121.91/023F220 | 188,00 |
| | | | | 121.91/023F3000 | 238,00 |
| €/Satz/Set/Jeu/Juego | | | | | |
| Eurotrim ET900/ET1000 | kompletter Satz complete set | = 3 Messer = 3 knives | 13,40 | 121.91/300F220 | 587,00 |
| | | | | 121.91/300F3000 | 739,00 |



HEROLD

(Eterna/Tempo)

| Maschinen-Typ Type/Type/Tipo | Abmessungen in mm Size/Dimension/Tamaño | Löcher/Holes Trous/Huecos |  kg | FASSCO-Id. Qualität/Quality/Calid. | €/Stück Pce./Pce./Pza. |
|---|--|------------------------------|---|---------------------------------------|---------------------------|
| TH 46 TS 46 | 570 x 70 x 6 | 5/M10 | 1,65 | 002.01F220 | * |
| | | | | 002.01F3000 | * |
| H 51 | 650 x 85 x 6,5 | 5/M10 | 2,45 | 002.15F220 | * |
| | | | | 002.15F3000 | * |
| TS 52 TS 52 HY | 725 x 100 x 9 | 4/M10 | 4,50 | 002.11F220 | * |
| | | | | 002.11F3000 | * |
| S 65 | 785 x 85 x 6,5 | 6/M10 | 3,00 | 002.02F220 | * |
| | | | | 002.02F3000 | * |
| H 65 | 785 x 85 x 9 | 6/M10 | 4,15 | 002.10F220 | * |
| | | | | 002.10F3000 | * |
| H 72 | 885 x 90 x 7 | 6/M10 | 3,85 | 002.07F220 | * |
| | | | | 002.07F3000 | * |
| H 72 neu ab 6/67 | 905 x 90 x 7 | 6/M10 | 3,90 | 002.08F220 | * |
| | | | | 002.08F3000 | * |
| TS 72 TS 72 HY | 945 x 100 x 9 | 6/M10 | 5,85 | 002.12F220 | * |
| | | | | 002.12F3000 | * |
| S 76 | 970 x 90 x 7 | 7/M10 | 4,30 | 002.03F220 | * |
| | | | | 002.03F3000 | * |
| S 83 bis Masch.-Nr. 3559 | 1035 x 90 x 7 | 8/M10 | 4,50 | 002.04F220 | * |
| | | | | 002.04F3000 | * |
| S 83 ab Masch.-Nr. 3560 (S 72 ES) | 1035 x 90 x 9 | 8/M10 | 5,70 | 002.05F220 | * |
| | | | | 002.05F3000 | * |
| S 88 L/E S 90 L | 1155 x 100 x 10 | 8/M10 | 8,00 | 002.06F220 | * |
| | | | | 002.06F3000 | * |
| S 92 L | 1220 x 130 x 12 | 8/M10 | 13,20 | 002.13F220 | * |
| | | | | 002.13F3000 | * |
| S 107 C S 110 | 1310 x 140 x 13 | 8/M12 | 16,55 | 002.09F220 | * |
| | | | | 002.09F3000 | * |
| S 107 S | 1365 x 140 x 13 | 8/M12 | 17,25 | 002.16F220 | * |
| | | | | 002.16F3000 | * |
| S 115 | 1550 x 150 x 15 | 8/M12 | 24,25 | 002.14F220 | * |
| | | | | 002.14F3000 | * |

E
F
G
H

HÖRAUF

(Stahl/VBF)



| Maschinen-Typ Type/Type/Tipo | Abmessungen in mm Size/Dimension/Tamaño | Löcher/Holes Trous/Huecos | ⚖️ kg | FASSCO-Id. Qualität/Quality/Calid. | €/Stück Pce./Pce./Pza. |
|---------------------------------|---|------------------------------|----------|---------------------------------------|---------------------------|
| BS SN 130 717 | Vordermesser 460 x 130 x 11,8 | 8/M12 | 4,70 | 001.91/001F220 | * |
| | | | | 001.91/001F3000 | * |
| | Seitenmesser, links (Trennschnittmesser) 410 x 145 x 11,8 | 6/M12 | 3,95 | 001.92/002F220 | * |
| | | | | 001.92/002F3000 | * |
| | Seitenmesser, rechts 410 x 130 x 11,8 | 6/M12 | 3,55 | 001.91/003F220 | * |
| | | | | 001.91/003F3000 | * |
| €/Satz/Set/Jeu/Juego | | | | | |
| BS SN 130 717 | kompletter Satz complete set | = 3 Messer = 3 knives | 12,20 | 001.92/300F220 | * |
| | | | | 001.92/300F3000 | * |

| Maschinen-Typ Type/Type/Tipo | Abmessungen in mm Size/Dimension/Tamaño | Löcher/Holes Trous/Huecos | ⚖️ kg | FASSCO-Id. Qualität/Quality/Calid. | €/Stück Pce./Pce./Pza. |
|---------------------------------|--|------------------------------|----------|---------------------------------------|---------------------------|
| AVH 72 SN 131 | Vordermesser 560 x 122 x 12,8 | 8/M12 | 6,00 | 001.94/001F220 | * |
| | | | | 001.94/001F3000 | * |
| | Seitenmesser, links 453 x 150 x 12,8 | 6/M12 | 4,95 | 001.94/002F220 | * |
| | | | | 001.94/002F3000 | * |
| | Seitenmesser, rechts 453 x 150 x 12,8 | 6/M12 | 4,95 | 001.94/003F220 | * |
| | | | | 001.94/003F3000 | * |
| €/Satz/Set/Jeu/Juego | | | | | |
| AVH 72 SN 131 | kompletter Satz complete set | = 3 Messer = 3 knives | 15,90 | 001.94/300F220 | * |
| | | | | 001.94/300F3000 | * |

| Maschinen-Typ Type/Type/Tipo | Abmessungen in mm Size/Dimension/Tamaño | Löcher/Holes Trous/Huecos | ⚖️ kg | FASSCO-Id. Qualität/Quality/Calid. | €/Stück Pce./Pce./Pza. |
|---------------------------------|--|------------------------------|----------|---------------------------------------|---------------------------|
| SN 135 A | Vordermesser 475 x 130 x 11,8 | 8/M12 | 4,90 | 021.95/001F220 | * |
| | | | | 021.95/001F3000 | * |
| | Seitenmesser, links 425 x 150 x 15,8 | 6/M12 2/M8 m.Ausfr. | 5,40 | 021.95/002F220 | * |
| | | | | 021.95/002F3000 | * |
| | Seitenmesser, rechts 425 x 150 x 15,8 | 6/M12 2/M8 m.Ausfr. | 5,40 | 021.95/003F220 | * |
| | | | | 021.95/003F3000 | * |
| €/Satz/Set/Jeu/Juego | | | | | |
| SN 135 A | kompletter Satz complete set | = 3 Messer = 3 knives | 15,70 | 021.95/300F220 | * |
| | | | | 021.95/300F3000 | * |

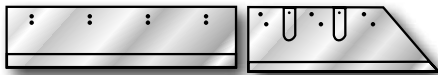

HÖRAUF

(Stahl/VBF)

E
F
G
H

| Maschinen-Typ Type/Type/Tipo | Abmessungen in mm Size/Dimension/Tamaño | Löcher/Holes Trous/Huecos | △ kg | FASSCO-Id. Qualität/Quality/Calid. | €/Stück Pce./Pce./Pza. |
|---------------------------------|--|------------------------------|---------|---------------------------------------|---------------------------|
| SN 138/140 145 AF 150 SN | Vordermesser 475 x 130 x 11,8 | 8/M12 | 4,90 | 021.95/001F220 | * |
| | | | | 021.95/001F3000 | * |
| | Seitenmesser, links 405 x 150 x 15,8 | 6/M12 2/M8 m.Ausfr. | 5,10 | 021.97/002F220 | * |
| | | | | 021.97/002F3000 | * |
| | Seitenmesser, rechts 405 x 150 x 15,8 | 6/M12 2/M8 m.Ausfr. | 5,10 | 021.97/003F220 | * |
| | | | | 021.97/003F3000 | * |
| €/Satz/Set/Jeu/Juego | | | | | |
| SN 138/140 145 AF 150 SN | kompletter Satz complete set | = 3 Messer = 3 knives | 15,10 | 021.97/300F220 | * |
| | | | | 021.97/300F3000 | * |

| Maschinen-Typ Type/Type/Tipo | Abmessungen in mm Size/Dimension/Tamaño | Löcher/Holes Trous/Huecos | △ kg | FASSCO-Id. Qualität/Quality/Calid. | €/Stück Pce./Pce./Pza. |
|---------------------------------|--|------------------------------|---------|---------------------------------------|---------------------------|
| 2001 135 S | Vordermesser 7357026688 475 x 130 x 11,8 | 8/M12 | 4,90 | 021.95/001F220 | * |
| | | | | 021.95/001F3000 | * |
| | Seitenmesser, links 7357026686 440 x 150 x 15,8 | 6/M12 2/M8 m.Ausfr. | 5,80 | 021.96/002F220 | * |
| | | | | 021.96/002F3000 | * |
| | Seitenmesser, rechts 7357026687 440 x 150 x 15,8 | 6/M12 2/M8 m.Ausfr. | 5,80 | 021.96/003F220 | * |
| | | | | 021.96/003F3000 | * |
| €/Satz/Set/Jeu/Juego | | | | | |
| 2001 135 S | kompletter Satz complete set | = 3 Messer = 3 knives | 16,50 | 021.96/300F220 | * |
| | | | | 021.96/300F3000 | * |

| Maschinen-Typ Type/Type/Tipo | Abmessungen in mm Size/Dimension/Tamaño | Löcher/Holes Trous/Huecos | △ kg | FASSCO-Id. Qualität/Quality/Calid. | €/Stück Pce./Pce./Pza. |
|----------------------------------|---|------------------------------|---------|---------------------------------------|---------------------------|
| SN 140 45° Schnitt 45° cut | Vordermesser (7357026688) 735146012 475 x 130 x 11,8 | 8/M12 | 4,90 | 021.95/001F220 | * |
| | | | | 021.95/001F3000 | * |
| | Seitenmesser, links (735146007) (735146009) 735146010 440 x 150 x 15,8 | 6/M12 2/M8 m.Ausfr. | 5,80 | 021.99/002F220 | * |
| | | | | 021.99/002F3000 | * |
| | Seitenmesser, rechts (735146006) (735146008) 735146011 440 x 150 x 15,8 | 6/M12 2/M8 m.Ausfr. | 5,80 | 021.99/003F220 | * |
| | | | | 021.99/003F3000 | * |
| €/Satz/Set/Jeu/Juego | | | | | |
| SN 140 45° Schnitt 45° cut | kompletter Satz complete set | = 3 Messer = 3 knives | 16,50 | 021.99/300F220 | * |
| | | | | 021.99/300F3000 | * |

HÖRAUF

(Stahl/VBF)



| Maschinen-Typ Type/Type/Tipo | Abmessungen in mm Size/Dimension/Tamaño | Löcher/Holes Trous/Huecos | ⚖️ kg | FASSCO-Id. Qualität/Quality/Calid. | €/Stück Pce./Pce./Pza. |
|----------------------------------|--|------------------------------|----------|---------------------------------------|---------------------------|
| SN 140 vergrößertes Format | Vordermesser 7357032309 | 8/M12 | 5,30 | 021.98/001F220 | * |
| | 515 x 130 x 11,8 | | | 021.98/001F3000 | * |

HOHNER

(MBO Digi finisher)



| Maschinen-Typ Type/Type/Tipo | Abmessungen in mm Size/Dimension/Tamaño | Löcher/Holes Trous/Huecos | ⚖️ kg | FASSCO-Id. Qualität/Quality/Calid. | €/Stück Pce./Pce./Pza. |
|--|--|---------------------------------|----------|---------------------------------------|---------------------------|
| T3 Sammelhefter Saddle binder EPT3/Exact HSB 5000 (HSB 7000)* | Vordermesser, oben 31 45675 448 x 80 x 10 | 6 Langlöcher 8/M8x1 2/M6 | 2,25 | 086.92/001F3000 | 240,00 |
| | Seitenmesser, oben links 31 45341 362 x 80 x 10 | 5 Langlöcher 11/M8x1 2/M6 | 1,75 | 086.92/045F3000 | 218,00 |
| | Seitenmesser, oben rechts 31 45341 362 x 80 x 10 | 5 Langlöcher 11/M8x1 2/M6 | 1,75 | 086.92/045F3000 | 218,00 |
| | Vordermesser, unten 31 45673 475 x 30 x 15 (4S) | 2 vers.Lö. | 1,38 | 086.92/101F236 | 160,00 |
| | Seitenmesser, unten links 31 45194 380 x 30 x 15 (4S) | 2 vers.Lö. | 1,13 | 086.92/123F236 | 134,00 |
| | Seitenmesser, unten rechts 31 45194 380 x 30 x 15 (4S) | 2 vers.Lö. | 1,13 | 086.92/123F236 | 134,00 |
| €/Satz/Set/Jeu/Juego | | | | | |
| T3 Sammelhefter EPT3/Exact HSB 5000 (HSB 7000)* | Satz Obermesser Set Upper knives | = 3 Messer = 3 knives | 5,75 | 086.92/300F3000 | 676,00 |
| | Satz Untermesser Set Bottom knives | = 3 Messer = 3 knives | 3,64 | 086.92/303F236 | 428,00 |

* Nur einige alte Maschinen

* Some old machines only

| Maschinen-Typ Type/Type/Tipo | Abmessungen in mm Size/Dimension/Tamaño | Löcher/Holes Trous/Huecos | ⚖️ kg | FASSCO-Id. Qualität/Quality/Calid. | €/Stück Pce./Pce./Pza. |
|---------------------------------|--|--------------------------------|----------|---------------------------------------|---------------------------|
| T3 alte Länge old length | Seitenmesser, oben links 31 45219 350 x 80 x 10 | 5 Langlöcher 6/M8x1 2/M6 | 1,70 | 086.92/023F3000 | 227,00 |
| | Seitenmesser, oben rechts 31 45219 350 x 80 x 10 | 5 Langlöcher 6/M8x1 2/M6 | 1,70 | 086.92/023F3000 | 227,00 |



HOHNER

| Maschinen-Typ Type/Type/Tipo | Abmessungen in mm Size/Dimension/Tamaño | Löcher/Holes Trous/Huecos | △ kg | FASSCO-Id. Qualität/Quality/Calid. | €/Stück Pce./Pce./Pza. |
|---------------------------------|--|---------------------------------|---------|---------------------------------------|---------------------------|
| T3 HSB 7000 | Vordermesser, oben 3147675 448 x 80 x 10 | 6 Langlöcher 6/M8x1 2/M6 | 2,25 | 086.94/001F3000 | 240,00 |
| | Seitenmesser, oben links* 3145341 362 x 80 x 10 | 5 Langlöcher 11/M8x1 2/M6 | 1,80 | 086.92/045F3000 | 218,00 |
| | Seitenmesser, oben rechts* 3145341 362 x 80 x 10 | 5 Langlöcher 11/M8x1 2/M6 | 1,80 | 086.92/045F3000 | 218,00 |
| | Vordermesser, unten 3175372a 475 x 25 x 15 (1S) | 5 vers.Lö. 4/5Ø | 1,10 | 086.93/111F236 | 160,00 |
| | Seitenmesser, unten links 3175358a 380 x 25 x 15 (1S) | 5 vers.Lö. 4/5Ø | 0,85 | 086.93/134F236 | 128,00 |
| | Seitenmesser, unten rechts 3175358a 380 x 25 x 15 (1S) | 5 vers.Lö. 4/5Ø | 0,85 | 086.93/134F236 | 128,00 |
| €/Satz/Set/Jeu/Juego | | | | | |
| T3 HSB 7000 | Satz Obermesser Set Upper knives | = 3 Messer = 3 knives | 5,85 | 086.94/300F3000 | 676,00 |
| | Satz Untermesser Set Bottom knives | = 3 Messer = 3 knives | 2,80 | 086.94/303F236 | 416,00 |

* Ersatz für 086.94/023 - 3147692 / * Replacement for 086.94/023 - 3147692



HOHNER

| Maschinen-Typ Type/Type/Tipo | Abmessungen in mm Size/Dimension/Tamaño | Löcher/Holes Trous/Huecos | △ kg | FASSCO-Id. Qualität/Quality/Calid. | €/Stück Pce./Pce./Pza. |
|---------------------------------|--|------------------------------|---------|---------------------------------------|---------------------------|
| Trimmer HSB 8000 | Vordermesser, oben 317 7383 425 x 80 x 10 | 5/M10x1 2/M5 | 2,30 | 086.96/001F3000 | 192,00 |
| | Seitenmesser, oben links 317 5453 362 x 80 x 10 | 5/M10x1 2/M5 | 1,80 | 086.93/023F3000 | 166,00 |
| | Seitenmesser, oben rechts 317 5453 362 x 80 x 10 | 5/M10x1 2/M5 | 1,80 | 086.93/023F3000 | 166,00 |
| | Vordermesser, unten 317 7373a 435 x 25 x 15 (1S) | 5 vers.Lö. 4/5Ø | 1,10 | 086.96/101F236 | 144,00 |
| | Seitenmesser, unten links 3175358a 380 x 25 x 15 (1S) | 5 vers.Lö. 4/5Ø | 0,85 | 086.93/134F236 | 128,00 |
| | Seitenmesser, unten rechts 3175358a 380 x 25 x 15 (1S) | 5 vers.Lö. 4/5Ø | 0,85 | 086.93/134F236 | 128,00 |
| €/Satz/Set/Jeu/Juego | | | | | |
| Trimmer HSB 8000 | Satz Obermesser Set Upper knives | = 3 Messer = 3 knives | 5,90 | 086.96/300F3000 | 524,00 |
| | Satz Untermesser Set Bottom knives | = 3 Messer = 3 knives | 2,80 | 086.96/303F236 | 400,00 |

HOHNER



| Maschinen-Typ Type/Type/Tipo | Abmessungen in mm Size/Dimension/Tamaño | Löcher/Holes Trous/Huecos | kg | FASSCO-Id. Qualität/Quality/Calid. | €/Stück Pce./Pce./Pza. |
|--|---|------------------------------|------|---------------------------------------|---------------------------|
| Trimmer HSB 10.000 HSB 10.000-S | Vordermesser, oben 3175383 3175385/3175387 520 x 80 x 10 | 6/M10x1 2/M5 | 2,70 | 086.95/001F3000 | 228,00 |
| | Seitenmesser, oben links 317 5453 362 x 80 x 10 | 5/M10x1 2/M5 | 1,80 | 086.93/023F3000 | 166,00 |
| | Seitenmesser, oben rechts 317 5453 362 x 80 x 10 | 5/M10x1 2/M5 | 1,80 | 086.93/023F3000 | 166,00 |
| | Vordermesser, unten 3175373 3175374 545 x 25 x 15 (1S) | 5 vers.Lö. 4/5Ø | 1,30 | 086.95/101F236 | 167,00 |
| | Seitenmesser, unten links 3175358a 380 x 25 x 15 (1S) | 5 vers.Lö. 4/5Ø | 0,85 | 086.93/134F236 | 128,00 |
| | Seitenmesser, unten rechts 3175358a 380 x 25 x 15 (1S) | 5 vers.Lö. 4/5Ø | 0,85 | 086.93/134F236 | 128,00 |
| €/Satz/Set/Jeu/Juego | | | | | |
| Trimmer HSB 10.000 HSB 10.000-S | Satz Obermesser Set Upper knives | = 3 Messer = 3 knives | 6,30 | 086.95/300F3000 | 560,00 |
| | Satz Untermesser Set Bottom knives | = 3 Messer = 3 knives | 3,00 | 086.95/303F236 | 423,00 |

| Maschinen-Typ Type/Type/Tipo | Abmessungen in mm Size/Dimension/Tamaño | Löcher/Holes Trous/Huecos | kg | FASSCO-Id. Qualität/Quality/Calid. | €/Stück Pce./Pce./Pza. |
|-----------------------------------|--|------------------------------|------|---------------------------------------|---------------------------|
| Trimmer Zwischenmodell | Vordermesser, oben 317 5382 448 x 80 x 10 | 6/M10x1 2/M5 | 2,30 | 086.93/001F3000 | 210,00 |
| | Seitenmesser, oben links 317 5453 362 x 80 x 10 | 5/M10x1 2/M5 | 1,80 | 086.93/023F3000 | 166,00 |
| | Seitenmesser, oben rechts 317 5453 362 x 80 x 10 | 5/M10x1 2/M5 | 1,80 | 086.93/023F3000 | 166,00 |
| | Vordermesser, unten 317 5372 475 x 25 x 15 (4S) | 5 vers.Lö. 4/5Ø | 1,10 | 086.93/101F236 | 160,00 |
| | Seitenmesser, unten links 317 5358 380 x 25 x 15 (4S) | 5 vers.Lö. 4/5Ø | 0,85 | 086.93/123F236 | 128,00 |
| | Seitenmesser, unten rechts 317 5358 380 x 25 x 15 (4S) | 5 vers.Lö. 4/5Ø | 0,85 | 086.93/123F236 | 128,00 |
| €/Satz/Set/Jeu/Juego | | | | | |
| Trimmer Zwischenmodell | Satz Obermesser Set Upper knives | = 3 Messer = 3 knives | 5,90 | 086.93/300F3000 | 542,00 |
| | Satz Untermesser Set Bottom knives | = 3 Messer = 3 knives | 2,80 | 086.93/303F236 | 416,00 |

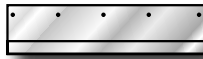

HOHNER

| Maschinen-Typ Type/Type/Tipo | Abmessungen in mm Size/Dimension/Tamaño | Löcher/Holes Trous/Huecos |  kg | FASSCO-Id. Qualität/Quality/Calid. | €/Stück Pce./Pce./Pza. |
|---|---|------------------------------|---|---------------------------------------|---------------------------|
| Trimmer HSB 8000 Kleinformat (9977650) | Vordermesser, oben 317 7383 425 x 80 x 10 | 6/M10x1 2/M5 | 2,70 | 086.96/001F3000 | 192,00 |
| | Seitenmesser, oben links 317 5453 362 x 80 x 10 | 5/M10x1 2/M5 | 1,80 | 086.93/023F3000 | 166,00 |
| | Seitenmesser, oben rechts 317 5453 362 x 80 x 10 | 5/M10x1 2/M5 | 1,80 | 086.93/023F3000 | 166,00 |
| | Vordermesser, unten 317 7373a 435 x 25 x 15 (1S) | 5 vers.Lö. 4/5Ø | 1,10 | 086.96/101F236 | 144,00 |
| | Seitenmesser, unten links 3177315 380 x 20 x 15 (1S) | 5 vers.Lö. 4/5Ø | 0,60 | 086.71/123F236 | 128,00 |
| | Seitenmesser, unten rechts 3177315 380 x 20 x 15 (1S) | 5 vers.Lö. 4/5Ø | 0,60 | 086.71/123F236 | 128,00 |
| €/Satz/Set/Jeu/Juego | | | | | |
| Trimmer HSB 8000 Kleinformat (9997650) | Satz Obermesser Set Upper knives | = 3 Messer = 3 knives | 5,90 | 086.96/300F3000 | 524,00 |
| | Satz Untermesser Set Bottom knives | = 3 Messer = 3 knives | 2,30 | 086.97/303F236 | 400,00 |



HOHNER

| Maschinen-Typ Type/Type/Tipo | Abmessungen in mm Size/Dimension/Tamaño | Löcher/Holes Trous/Huecos |  kg | FASSCO-Id. Qualität/Quality/Calid. | €/Stück Pce./Pce./Pza. |
|---|--|------------------------------|---|---------------------------------------|---------------------------|
| Stanzschnitt Obermesser V-Fase Punch Cut Top knife V-Shape | Obermesser 317 6145 362 x 88/75 x 4 | 5 Langlöcher | 0,80 | 086.60/004F236 | 260,00 |
| | Obermesser 317 6186 362 x 88/75 x 5 | 5 Langlöcher | 1,00 | 086.60/005F236 | 260,00 |
| | Obermesser 314 7811 362 x 88/75 x 6 | 5 Langlöcher | 1,15 | 086.60/006F236 | 260,00 |
| | Obermesser 317 6361 362 x 88/75 x 8 | 5 Langlöcher | 1,50 | 086.60/008F236 | 303,00 |
| | Obermesser 314 7812 362 x 88/75 x 9 | 5 Langlöcher | 1,65 | 086.60/009F236 | 312,00 |
| | Obermesser 317 6363 362 x 88/75 x 10 | 5 Langlöcher | 1,85 | 086.60/010F236 | 335,00 |
| | Obermesser 317 6175 362 x 88/75 x 12 | 5 Langlöcher | 1,89 | 086.60/012F236 | 342,00 |

HOHNER

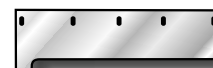

| Maschinen-Typ Type/Type/Tipo | Abmessungen in mm Size/Dimension/Tamaño | Löcher/Holes Trous/Huecos | △ kg | FASSCO-Id. Qualität/Quality/Calid. | €/Stück Pce./Pce./Pza. |
|--|--|------------------------------|---------|---------------------------------------|---------------------------|
| Stanzschnitt V-Fase mit Luft Punch Cut V-Shape with Air | Obermesser 317 6151 362 x 88/75 x 6 | 5 Langlöcher 2/8-2,5Ø | 1,15 | 086.60/206F236 | 291,00 |
| | Obermesser 317 6362 362 x 88/75 x 8 | 5 Langlöcher 2/8-2,5Ø | 1,50 | 086.60/208F236 | 336,00 |
| | Obermesser 317 6161 362 x 88/75 x 9 | 5 Langlöcher 2/8-2,5Ø | 1,65 | 086.60/209F236 | 336,00 |
| | Obermesser 317 6364 362 x 88/75 x 10 | 5 Langlöcher 2/8-2,5Ø | 1,80 | 086.60/210F236 | 370,00 |
| | Obermesser 317 6171 362 x 88/75 x 12 | 5 Langlöcher 2/8-2,5Ø | 1,89 | 086.60/212F236 | 378,00 |

| Maschinen-Typ Type/Type/Tipo | Abmessungen in mm Size/Dimension/Tamaño | Löcher/Holes Trous/Huecos | △ kg | FASSCO-Id. Qualität/Quality/Calid. | €/Stück Pce./Pce./Pza. |
|--|--|---------------------------------------|---------|---------------------------------------|---------------------------|
| Stanzschnitt Untermesser Punch cut Bottom knife 6-9mm Schnitt/cut | Untermesser, links 314 7885 410 x 17 x 12 | 5 zyl.vers. Langlöcher 5 Ta. R6 | 0,55 | 086.61/134F236 | 146,00 |
| | Untermesser, rechts 314 7885 410 x 17 x 12 | 5 zyl.vers. Langlöcher 5 Ta. R6 | 0,55 | 086.61/134F236 | 146,00 |
| Stanzschnitt Untermesser Sondermodell Punch cut Bottom knife Spezial type 4-6mm Schnitt/cut | Untermesser, links 314 7858 410 x 18,3 x 12 | 5 zyl.vers. Langlöcher 5 Ta. R6 | 0,60 | 086.61/156F236 | 159,00 |
| | Untermesser, rechts 314 7858 410 x 18,3 x 12 | 5 zyl.vers. Langlöcher 5 Ta. R6 | 0,60 | 086.61/156F236 | 159,00 |

| Maschinen-Typ Type/Type/Tipo | Abmessungen in mm Size/Dimension/Tamaño | Löcher/Holes Trous/Huecos | △ kg | FASSCO-Id. Qualität/Quality/Calid. | €/Stück Pce./Pce./Pza. |
|---|--|-----------------------------------|---------|---------------------------------------|---------------------------|
| Stanzschnitt Untermesser Punch cut Bottom knife 6-12mm Schnitt/cut | Untermesser, links 317 6172 380 x 25 x 15 | 5 zyl.vers. Langlöcher 4/5Ø | 0,85 | 086.63/123F36 | 161,00 |
| | Untermesser, rechts 317 6172 380 x 25 x 15 | 5 zyl.vers. Langlöcher 4/5Ø | 0,85 | 086.63/123F36 | 161,00 |

| Maschinen-Typ Type/Type/Tipo | Abmessungen in mm Size/Dimension/Tamaño | Löcher/Holes Trous/Huecos | △ kg | FASSCO-Id. Qualität/Quality/Calid. | €/Stück Pce./Pce./Pza. |
|--|--|-----------------------------------|---------|---------------------------------------|---------------------------|
| Trennschnitt Fase 22° Split cut Bevel 22° | Obermesser 314 7815 362 x 85/76 x 9 | 5 Langlöcher | 1,60 | 086.64/009F236 | 258,00 |
| | Untermesser 317 6182 380 x 28 x 15 | 5 zyl.vers. Langlöcher 4/5Ø | 0,90 | 086.63/134F236 | 168,00 |



HORIZON

| Maschinen-Typ Type/Type/Tipo | Abmessungen in mm Size/Dimension/Tamaño | Löcher/Holes Trous/Huecos | ⚖ kg | FASSCO-Id. Qualität/Quality/Calid. | €/Stück Pce./Pce./Pza. |
|---------------------------------|--|------------------------------|---------|---------------------------------------|---------------------------|
| PC 45 F-11 | 545 x 70 x 6 | 4/M10 | 1,55 | 078.04F220 | * |
| | | | | 078.04F3000 | * |
| PC 64 H-1 | 735 x 75 x 7,98 | 5/M10 | 3,05 | 078.01F220 | * |
| | | | | 078.01F3000 | * |
| APC 58 M-18 | 740 x 110 x 7,94 | 8/M10 | 4,50 | 078.02F220 | * |
| | | | | 078.02F3000 | * |
| T 61 | 750 x 110 x 7,94 | 8/M10 | 4,55 | 078.07F220 | * |
| | | | | 078.07F3000 | * |
| M-18 | 750 x 110 x 7,94 | 6/M10 | 4,55 | 078.05F220 | * |
| | | | | 078.05F3000 | * |
| H-1 | 755 x 75 x 8 | 5/M10 | 3,15 | 078.06F220 | * |
| | | | | 078.06F3000 | * |
| PC 61 | 765 x 110 x 7,94 | 10/M10 | 4,60 | 078.03F220 | * |
| | | | | 078.03F3000 | * |
| C 76 C 78 | 940 x 127 x 12,7 | 16/M12 +MWE | 10,50 | 013.01F220 | * |
| | | | | 013.01F3000 | * |
| 78M | 960 x 120 x 12,5 | 16/M12 +MWE | 9,95 | 078.08F220 | * |
| | | | | 078.08F3000 | * |
| C 920 M | 1080 x 127 x 12,7 | 18/M12 +MWE | 12,05 | 013.02F220 | * |
| | | | | 013.02F3000 | * |



HORIZON

Einmesser-Dreischneider

| Maschinen-Typ Type/Type/Tipo | Abmessungen in mm Size/Dimension/Tamaño | Löcher/Holes Trous/Huecos | ⚖ kg | FASSCO-Id. Qualität/Quality/Calid. | €/Stück Pce./Pce./Pza. |
|---------------------------------|--|------------------------------|---------|---------------------------------------|---------------------------|
| HT 70 HT 80 | 400 x 75 x 9,5 | 12/M8 | 1,80 | 078.91F3000 | 168,00 |

Einmesser-Dreischneider

| Maschinen-Typ Type/Type/Tipo | Abmessungen in mm Size/Dimension/Tamaño | Löcher/Holes Trous/Huecos | ⚖ kg | FASSCO-Id. Qualität/Quality/Calid. | €/Stück Pce./Pce./Pza. |
|---------------------------------|--|------------------------------|---------|---------------------------------------|---------------------------|
| HT 30 | 490 x 75 x 9,5 | 12/M8 3/M6 | 2,22 | 078.88F3000 | 205,00 |

HORIZON



| Maschinen-Typ Type/Type/Tipo | Abmessungen in mm Size/Dimension/Tamaño | Löcher/Holes Trous/Huecos | △ kg | FASSCO-Id. Qualität/Quality/Calid. | €/Stück Pce./Pce./Pza. |
|---------------------------------|---|------------------------------|---------|---------------------------------------|---------------------------|
| HTS-30 HTS-300P | Vordermesser, oben 405 x 85/65/55 x 10 | 5/M8 | 1,68 | 078.96/001F236 | 237,00 |
| | Seitenmesser, oben links 270 x 70/60 x 10 | 4/M8 | 1,15 | 078.96/002F236 | 113,00 |
| | Seitenmesser, oben rechts 270 x 70/60 x 10 | 4/M8 | 1,15 | 078.96/003F236 | 113,00 |
| | Vordermesser, unten 405 x 22 x 10 | 6 zyl. vers. Langlöcher | 0,64 | 078.96/101F236 | 164,00 |
| | Seitenmesser, unten links 300 x 22 x 10 | 5 zyl. vers. Langlöcher | 0,49 | 078.96/123F236 | 135,00 |
| | Seitenmesser, unten rechts 300 x 22 x 10 | 5 zyl. vers. Langlöcher | 0,49 | 078.96/123F236 | 135,00 |
| €/Satz/Set/Jeu/Juego | | | | | |
| HTS-30 HTS-300P | Satz Obermesser Set Upper knives | = 3 Messer = 3 knives | 3,98 | 078.96/300F236 | 463,00 |
| | Satz Untermesser Set Bottom knives | = 3 Messer = 3 knives | 1,62 | 078.96/303F236 | 434,00 |

HORIZON

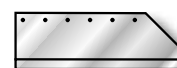
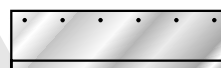

| Maschinen-Typ Type/Type/Tipo | Abmessungen in mm Size/Dimension/Tamaño | Löcher/Holes Trous/Huecos | △ kg | FASSCO-Id. Qualität/Quality/Calid. | €/Stück Pce./Pce./Pza. |
|---------------------------------|--|------------------------------|---------|---------------------------------------|---------------------------|
| HT-100 | Vordermesser 505 x 125 x 9,5 (M115201) | 6/M8 | 4,10 | 078.93/001F220 | * |
| | | | | 078.93/001F3000 | * |
| | Seitenmesser, links 425 x 125 x 9,5 (M115301) | 6/M8 | 3,10 | 078.93/002F220 | * |
| | | | | 078.93/002F3000 | * |
| | Seitenmesser, rechts 425 x 125 x 9,5 (M115302) | 6/M8 | 3,10 | 078.93/003F220 | * |
| | | | | 078.93/003F3000 | * |
| €/Satz/Set/Jeu/Juego | | | | | |
| HT-100 | kompletter Satz complete set | = 3 Messer = 3 knives | 10,30 | 078.93/300F220 | * |
| | | | | 078.93/300F3000 | * |

| Maschinen-Typ Type/Type/Tipo | Abmessungen in mm Size/Dimension/Tamaño | Löcher/Holes Trous/Huecos | △ kg | FASSCO-Id. Qualität/Quality/Calid. | €/Stück Pce./Pce./Pza. |
|---------------------------------|--|------------------------------|---------|---------------------------------------|---------------------------|
| HT-101 | Vordermesser, kurz 491 x 125 x 9,5 | 6/M8 | 4,00 | 078.95/001F220 | * |
| | | | | 078.95/001F3000 | * |
| | Seitenmesser, links 425 x 125 x 9,5 (M115301) | 6/M8 | 3,10 | 078.93/002F220 | * |
| | | | | 078.93/002F3000 | * |
| | Seitenmesser, rechts 425 x 125 x 9,5 (M115302) | 6/M8 | 3,10 | 078.93/003F220 | * |
| | | | | 078.93/003F3000 | * |
| €/Satz/Set/Jeu/Juego | | | | | |
| HT-101 | kompletter Satz complete set | = 3 Messer = 3 knives | 10,20 | 078.95/300F220 | * |
| | | | | 078.95/300F3000 | * |



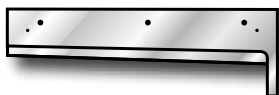

HORIZON Trimmer

| Maschinen-Typ Type/Type/Tipo | Abmessungen in mm Size/Dimension/Tamaño | Löcher/Holes Trous/Huecos | kg | FASSCO-Id. Qualität/Quality/Calid. | €/Stück Pce./Pce./Pza. |
|---------------------------------|--|------------------------------|------|---------------------------------------|---------------------------|
| FC-9 | Obermesser 370 x 87/68/55 x 10 | 3/11 Ø 2/12,3 Ø | 1,45 | 078.89/001F236 | * |
| | Untermesser 370 x 35 x 10/9 | 4 zyl.vers. Langlöcher | 0,90 | 078.89/101F236 | * |
| €/Satz/Set/Jeu/Juego | | | | | |
| FC-9 | kompletter Satz complete set | = 2 Messer = 2 knives | 2,35 | 078.89/200F236 | * |

| Maschinen-Typ Type/Type/Tipo | Abmessungen in mm Size/Dimension/Tamaño | Löcher/Holes Trous/Huecos | kg | FASSCO-Id. Qualität/Quality/Calid. | €/Stück Pce./Pce./Pza. |
|---------------------------------|--|------------------------------|------|---------------------------------------|---------------------------|
| FC-10 FC-11 | Obermesser 370 x 87/66/53 x 10 | 3/11 Ø 2/12,3 Ø | 1,45 | 078.90/001F236 | 255,00 |
| | Untermesser 370 x 35 x 10/9 | 4 zyl.vers. Langlöcher | 0,90 | 078.90/101F236 | 163,00 |
| €/Satz/Set/Jeu/Juego | | | | | |
| FC-10 FC-11 | kompletter Satz complete set | = 2 Messer = 2 knives | 2,35 | 078.90/200F236 | 418,00 |

| Maschinen-Typ Type/Type/Tipo | Abmessungen in mm Size/Dimension/Tamaño | Löcher/Holes Trous/Huecos | kg | FASSCO-Id. Qualität/Quality/Calid. | €/Stück Pce./Pce./Pza. |
|---------------------------------|--|------------------------------|------|---------------------------------------|---------------------------|
| FC-20 | Obermesser 400 x 98/76/62 x 10 | 4/11/16 Ø 2/12,5 Ø | 1,81 | 078.92/001F236 | 236,00 |
| | Untermesser 400 x 35 x 10/9 | 5 zyl.vers. Langlöcher | 0,97 | 078.92/101F236 | 161,00 |
| €/Satz/Set/Jeu/Juego | | | | | |
| FC-20 | kompletter Satz complete set | = 2 Messer = 2 knives | 2,78 | 078.92/200F236 | 397,00 |



| Maschinen-Typ Type/Type/Tipo | Abmessungen in mm Size/Dimension/Tamaño | Löcher/Holes Trous/Huecos | kg | FASSCO-Id. Qualität/Quality/Calid. | €/Stück Pce./Pce./Pza. |
|---------------------------------|--|------------------------------|------|---------------------------------------|---------------------------|
| FC 200 a altes Modell | Obermesser 400 x 98/76/62 x 10 | 4/9-16 Ø 2/M8 | 1,81 | 078.97/001F236 | 264,00 |
| | Untermesser 424 x 23,5 x 10 | 2 zyl.vers. Langlö., 2 LL | 0,75 | 078.97/101F236 | 172,00 |
| €/Satz/Set/Jeu/Juego | | | | | |
| FC-200 a altes Modell | kompletter Satz complete set | = 2 Messer = 2 knives | 2,56 | 078.97/200F236 | 436,00 |



| Maschinen-Typ Type/Type/Tipo | Abmessungen in mm Size/Dimension/Tamaño | Löcher/Holes Trous/Huecos | kg | FASSCO-Id. Qualität/Quality/Calid. | €/Stück Pce./Pce./Pza. |
|---------------------------------|--|------------------------------|------|---------------------------------------|---------------------------|
| FC 200 a neues Modell | Obermesser 400 x 98/76/62 x 10 | 4/9-16 Ø 2/M4 2/8,7 Ø | 1,81 | 078.97/002F236 | 264,00 |
| | Untermesser 424 x 23,5 x 10 | 2 zyl.vers. Langlö., 2 LL | 0,75 | 078.97/102F236 | 172,00 |
| €/Satz/Set/Jeu/Juego | | | | | |
| FC-200 a neues Modell | kompletter Satz complete set | = 2 Messer = 2 knives | 2,56 | 078.97A/200F236 | 436,00 |

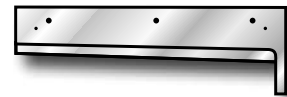

HORIZON

| Maschinen-Typ Type/Type/Tipo | Abmessungen in mm Size/Dimension/Tamaño | Löcher/Holes Trous/Huecos | △ kg | FASSCO-Id. Qualität/Quality/Calid. | €/Stück Pce./Pce./Pza. |
|--|--|------------------------------|---------|---------------------------------------|---------------------------|
| HTS-30 StitchLiner 5500 Stanzen V-Fase Punch cut V-Shape | Obermesser 284 x 90/70/60 x 5 | 4/M8 | 0,70 | 078.60/205F236 | * |
| | Obermesser (M132805-00) 284 x 90/70/60 x 6 | 4/M8 | 0,85 | 078.60/206F236 | * |
| | Obermesser 284 x 90/70/60 x 8 | 4/M8 | 1,12 | 078.60/208F236 | * |
| | Obermesser 284 x 90/70/60 x 10 | 4/M8 | 1,40 | 078.60/210F236 | * |
| | Obermesser 284 x 90/70/60 x 12 | 4/M8 | 1,60 | 078.60/212F236 | * |
| | Untermesser 300 x 25 x 10 | 5 zyl.vers. Langlöcher | 0,50 | 078.94/101F236 | * |

| Maschinen-Typ Type/Type/Tipo | Abmessungen in mm Size/Dimension/Tamaño | Löcher/Holes Trous/Huecos | △ kg | FASSCO-Id. Qualität/Quality/Calid. | €/Stück Pce./Pce./Pza. |
|---------------------------------|--|------------------------------|---------|---------------------------------------|---------------------------|
| HTS-30 Trennen Split cut | Trennmesser, oben 284 x 90/70/60 x 10 | 4/M8 | 1,40 | 078.64F236 | * |

HORIZON

| Maschinen-Typ Type/Type/Tipo | Abmessungen in mm Size/Dimension/Tamaño | Löcher/Holes Trous/Huecos | △ kg | FASSCO-Id. Qualität/Quality/Calid. | €/Stück Pce./Pce./Pza. |
|---------------------------------|--|------------------------------|---------|---------------------------------------|---------------------------|
| TBC-200L HTS-40 | Obermesser 405 x 100/80/55 x 10 | 5/M8 | 0,00 | 078.98/001F236 | * |
| | Seitenmesser, oben links M221353-01 330 x 103/79 x 10 | 2/M6 5/ø9 2/ø6,7 | 0,00 | 078.98/002F236 | * |
| | Seitenmesser, oben rechts M221354-01 330 x 103/79 x 10 | 2/M6 5/ø9 2/ø6,7 | 0,00 | 078.98/003F236 | * |
| | Vordermesser, unten 405 x 22 x 10 | 6 zyl. vers Langlöcher | 0,64 | 078.96/101F236 | * |
| | Seitenmesser, unten links 340 x 22 x 10 | 5 zyl. vers Langlöcher | 0,49 | 078.98/123F236 | * |
| | Seitenmesser, unten rechts 340 x 22 x 10 | 5 zyl.vers. Langlöcher | 0,49 | 078.98/123F236 | * |
| €/Satz/Set/Jeu/Juego | | | | | |
| TBC-200L HTS-40 | Satz Obermesser Set Upper knives | = 3 Messer = 3 knives | 3,98 | 078.98/300F236 | * |
| | Satz Untermesser Set Bottom knives | = 3 Messer = 3 knives | 1,62 | 078.98/303F236 | * |

HUNKELER

(Casagrande)

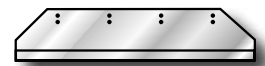

| Maschinen-Typ Type/Type/Tipo | Abmessungen in mm Size/Dimension/Tamaño | Löcher/Holes Trous/Huecos | ⚖️ kg | FASSCO-Id. Qualität/Quality/Calid. | €/Stück Pce./Pce./Pza. |
|---------------------------------|--|------------------------------|----------|---------------------------------------|---------------------------|
| HDS 36/46 SWISS Hydrocut | Vordermesser 630 x 120 x 10 | 10/M12 | 5,20 | 026.91/001F220 | * |
| | | | | 026.91/001F3000 | * |
| | Seitenmesser, links 530 x 120 x 10 | 8/M12 | 4,10 | 026.91/023F220 | * |
| | | | | 026.91/023F3000 | * |
| | Seitenmesser, rechts 530 x 120 x 10 | 8/M12 | 4,10 | 026.91/023F220 | * |
| | | | | 026.91/023F3000 | * |
| €/Satz/Set/Jeu/Juego | | | | | |
| HDS 36/46 SWISS Hydrocut | kompletter Satz complete set | = 3 Messer = 3 knives | 13,40 | 026.91/300F220 | * |
| | | | | 026.91/300F3000 | * |

| Maschinen-Typ Type/Type/Tipo | Abmessungen in mm Size/Dimension/Tamaño | Löcher/Holes Trous/Huecos | ⚖️ kg | FASSCO-Id. Qualität/Quality/Calid. | €/Stück Pce./Pce./Pza. |
|--|--|------------------------------|----------|---------------------------------------|---------------------------|
| HDS 36/47 Trennschnitt Split Cut | 398 x 120 x 10 | 6/M12 | 3,00 | 026.92F220 | * |
| | | | | 026.92F3000 | * |

| Maschinen-Typ Type/Type/Tipo | Abmessungen in mm Size/Dimension/Tamaño | Löcher/Holes Trous/Huecos | ⚖️ kg | FASSCO-Id. Qualität/Quality/Calid. | €/Stück Pce./Pce./Pza. |
|---------------------------------------|--|------------------------------|----------|---------------------------------------|---------------------------|
| ADS 42 Einmesser- dreischneider | 700 x 160 x 12 | 9 vers. Lö. | 9,30 | 026.90F220 | * |
| | | | | 026.90F3000 | * |

IMPERIAL



| Maschinen-Typ Type/Type/Tipo | Abmessungen in mm Size/Dimension/Tamaño | Löcher/Holes Trous/Huecos | ⚖️ kg | FASSCO-Id. Qualität/Quality/Calid. | €/Stück Pce./Pce./Pza. |
|---------------------------------|---|------------------------------|----------|---------------------------------------|---------------------------|
| 18-1/2" | 570 x 70 x 6 22.44" x 2.76" x .236" | 5/M10 | 1,65 | 089.01F220 | * |
| | | | | 089.01F3000 | * |
| 24" | 710 x 70 x 7,95 27.95" x 2.76" x .313" | 5/M10 | 2,75 | 089.04F220 | * |
| | | | | 089.04F3000 | * |
| 26" | 800 x 76 x 6,3 31.50" x 3.00" x .248" | 6/M10 | 2,65 | 089.02F220 | * |
| | | | | 089.02F3000 | * |
| 30"(*) | 900 x 101,6 x 9,9 35.43" x 4.00" x .390" | 12/M10 | 6,20 | 089.05F220 | * |
| | | | | 089.05F3000 | * |
| 45" | 1390 x 150 x 13,7 54.75" x 5.90" x .509" | 30/M12 | 19,85 | 089.03F220 | * |
| | | | | 089.03F3000 | * |

(*Für diese IMPERIAL-Typen ist eine Zeichnung erforderlich. / (*For these IMPERIAL -types a drawing is required.

ITOH IRON WORKS

(Jackal/QUEEN/ROBOCUT)

| Maschinen-Typ Type/Type/Tipo | Abmessungen in mm Size/Dimension/Tamaño | Löcher/Holes Trous/Huecos | △ kg | FASSCO-Id. Qualität/Quality/Calid. | €/Stück Pce./Pce./Pza. |
|--|--|------------------------------|---------|---------------------------------------|---------------------------|
| ITOH 72 JAC/QN 720 | 890 x 130 x 11,1 | 16 1/2"W 4/5 Ø | 8,90 | 069.06F220 | * |
| | | | | 069.06F3000 | * |
| ITOH-tec eRC 82 | 995 x 130 x 11,1 | 9/M12 | 8,90 | 069.15F220 | * |
| | | | | 069.15F3000 | * |
| ITOH 85 JAC/QN 850 | 1070 x 130 x 12,7 | 22 1/2"W 6/5 Ø | 12,25 | 069.01F220 | * |
| | | | | 069.01F3000 | * |
| ITOH 100 JAC/QN 1000 | 1220 x 140 x 12,7 | 28 1/2"W 6/5 Ø | 15,05 | 069.02F220 | * |
| | | | | 069.02F3000 | * |
| ITOH 100 JAC/QN 1000 | 1250 x 140 x 12,7 | 26 1/2"W | 15,55 | 069.16F220 | * |
| | | | | 069.16F3000 | * |
| ITOH-tec 100 ROBOCUT 100 | 1270 x 150 x 12,7 | 28 1/2"W +MWE | 16,70 | 069.14F220 | * |
| | | | | 069.14F3000 | * |
| ITOH 115 (A) JAC/QN 1150 | 1390 x 150 x 13,7 | 30 1/2"W 7/5 Ø | 19,85 | 069.03F220 | * |
| | | | | 069.03F3000 | * |
| ITOH 115 (B) JAC/QN 1150 ROBOCUT 115 | 1410 x 150 x 13,7 | 30 1/2"W 7/5 Ø | 20,15 | 069.09F220 | * |
| | | | | 069.09F3000 | * |
| ITOH RC 115 DX ITOH-tec 115 JAC/QN | 1410 x 150 x 13,7 | 29 1/2"W 6/5,1 Ø +MWE | 20,10 | 069.13F220 | * |
| | | | | 069.13F3000 | * |
| ITOH 130 JAC/QN 1300 | 1530 x 150 x 13,7 | 32 1/2"W 7/5 Ø | 21,80 | 069.04F220 | * |
| | | | | 069.04F3000 | * |
| ITOH 132 JAC/QN 1320 | 1560 x 150 x 13,7 | 32 1/2"W 7/5 Ø | 22,25 | 069.07F220 | * |
| | | | | 069.07F3000 | * |
| ITOH 137 JAC/QN 1370 ROBOCUT 137 | 1610 x 150 x 13,7 | 34 1/2"W 7/5 Ø | 23,00 | 069.11F220 | * |
| | | | | 069.11F3000 | * |
| ITOH 147 JAC/QN 1470 | 1700 x 150 x 14,2 | 32 1/2"W 7/5 Ø | 25,10 | 069.05F220 | * |
| | | | | 069.05F3000 | * |
| ITOH 160 JAC/QN 1600 | 1850 x 165 x 14,2 | 34/M12 7/5 Ø | 30,10 | 069.10F220 | * |
| | | | | 069.10F3000 | * |
| ITOH 170 JAC/QN 1700 | 1900 x 165 x 14,2 | 36/M12 7/5 Ø | 30,95 | 069.08F220 | * |
| | | | | 069.08F3000 | * |
| ITOH 200 JAC/QN 2000 | 2260 x 160 x 14,2 | 42 1/2"W 6/5 Ø | 35,65 | 069.12F220 | * |
| | | | | 069.12F3000 | * |

I
J
K
L

ITOH IRON WORKS

(SANKOH SEIKI)



| Maschinen-Typ Type/Type/Tipo | Abmessungen in mm Size/Dimension/Tamaño | Löcher/Holes Trous/Huecos | △ kg | FASSCO-Id. Qualität/Quality/Calid. | €/Stück Pce./Pce./Pza. |
|---------------------------------|--|------------------------------|---------|---------------------------------------|---------------------------|
| ITOH SANKOH | Vordermesser, oben 490 x 140/75/65 x 6 | 12/M6 | 1,48 | 069.90/001F236 | * |
| | Seitenmesser, oben links 355,4 x 65/55 x 6 | 16/M6 | 0,84 | 069.90/002F236 | * |
| | Seitenmesser, oben rechts 355,4 x 65/55 x 6 | 16/M6 | 0,84 | 069.90/003F236 | * |
| | Vordermesser, unten 500 x 40 x 15/9,7 | 5 vers. Lö. | 1,65 | 069.90/101F236 | * |
| | Seitenmesser, unten links 357,8 x 40 x 15/10 | 3 vers. Lö. | 1,14 | 069.90/102F236 | * |
| | Seitenmesser, unten rechts 357,8 x 40 x 15/10 | 3 vers. Lö. | 1,14 | 069.90/103F236 | * |
| €/Satz/Set/Jeu/Juego | | | | | |
| ITOH SANKOH | Satz Obermesser Set Upper knives | = 3 Messer = 3 knives | 3,16 | 069.90/300F236 | * |
| | Satz Untermesser Set Bottom knives | = 3 Messer = 3 knives | 3,93 | 069.90/303F236 | * |

| Maschinen-Typ Type/Type/Tipo | Abmessungen in mm Size/Dimension/Tamaño | Löcher/Holes Trous/Huecos | △ kg | FASSCO-Id. Qualität/Quality/Calid. | €/Stück Pce./Pce./Pza. |
|---|--|------------------------------|---------|---------------------------------------|---------------------------|
| TM-2 Stanzen Fase 90° Punch Cut Bevel 90° | Obermesser (5/32") 350 x 165/82/60 x 4 | 5 Langlöcher | 0,79 | 069.60/004F236 | * |
| | Obermesser (3/16") 350 x 165/82/60 x 5 | 5 Langlöcher | 0,98 | 069.60/005F236 | * |
| | Obermesser (1/4") 350 x 165/82/60 x 6 | 5 Langlöcher | 1,20 | 069.60/006F236 | * |
| | Obermesser (5/16") 350 x 165/82/60 x 8 | 5 Langlöcher | 1,58 | 069.60/008F236 | * |
| | Obermesser (3/8") 350 x 165/82/60 x 10 | 5 Langlöcher | 1,98 | 069.60/010F236 | * |
| | Untermesser, links 350 x 58 x 6,0/5,7 | 5/M6 | 0,76 | 069.61/102F236 | * |
| | Untermesser, rechts 350 x 58 x 6,0/5,7 | 5/M6 | 0,76 | 069.61/103F236 | * |



ITOH IRON WORKS

| Maschinen-Typ Type/Type/Tipo | Abmessungen in mm Size/Dimension/Tamaño | Löcher/Holes Trous/Huecos | ⚖️ kg | FASSCO-Id. Qualität/Quality/Calid. | €/Stück Pce./Pce./Pza. |
|---------------------------------|--|------------------------------|----------|---------------------------------------|---------------------------|
| ITM | Vordermesser, oben 450 x 100 x 13 | 6 Langlöcher 1/M12 | 3,90 | 069.91/001F3000 | * |
| | Seitenmesser, oben links 330 x 100 x 13 | 4 Langlöcher 1/M12 | 3,00 | 069.91/023F3000 | * |
| | Seitenmesser, oben rechts 330 x 100 x 13 | 4 Langlöcher 1/M12 | 3,00 | 069.91/023F3000 | * |
| | Vordermesser, unten 460 x 50 x 14/10 | 5 zyl.vers. Langlöcher | 1,80 | 069.91/101F236 | * |
| | Seitenmesser, unten links 340 x 50 x 14/10 | 4 zyl.vers. Langlöcher | 1,35 | 069.91/123F236 | * |
| | Seitenmesser, unten rechts 340 x 50 x 14/10 | 4 zyl.vers. Langlöcher | 1,35 | 069.91/123F236 | * |
| €/Satz/Set/Jeu/Juego | | | | | |
| ITM | Satz Obermesser Set Upper knives | = 3 Messer = 3 knives | 9,90 | 069.91/300F3000 | * |
| | Satz Untermesser Set Bottom knives | = 3 Messer = 3 knives | 4,50 | 069.91/303F236 | * |

| Maschinen-Typ Type/Type/Tipo | Abmessungen in mm Size/Dimension/Tamaño | Löcher/Holes Trous/Huecos | ⚖️ kg | FASSCO-Id. Qualität/Quality/Calid. | €/Stück Pce./Pce./Pza. |
|---------------------------------|--|------------------------------|----------|---------------------------------------|---------------------------|
| ITM | Vordermesser, oben 450 x 100 x 13 | 6 Langlöcher 1/M12 | 3,90 | 069.91/001F3000 | * |
| | Seitenmesser, oben links 360 x 100 x 13 | 5 Langlöcher 2 7/16" W | 3,25 | 069.92/023F3000 | * |
| | Seitenmesser, oben rechts 360 x 100 x 13 | 5 Langlöcher 2 7/16" W | 3,25 | 069.92/023F3000 | * |
| | Vordermesser, unten 460 x 50 x 14/10 | 5 zyl.vers. Langlöcher | 1,80 | 069.91/101F236 | * |
| | Seitenmesser, unten links 370 x 50 x 14/10 | 5 zyl.vers. Langlöcher | 1,45 | 069.92/123F236 | * |
| | Seitenmesser, unten rechts 370 x 50 x 14/10 | 5 zyl.vers. Langlöcher | 1,45 | 069.92/123F236 | * |
| €/Satz/Set/Jeu/Juego | | | | | |
| ITM | Satz Obermesser Set Upper knives | = 3 Messer = 3 knives | 10,40 | 069.92/300F3000 | * |
| | Satz Untermesser Set Bottom knives | = 3 Messer = 3 knives | 4,70 | 069.92/303F236 | * |

JUD

(CHALLENGER/FEIDA)



| Maschinen-Typ Type/Type/Tipo | Abmessungen in mm Size/Dimension/Tamaño | Löcher/Holes Trous/Huecos | ⚖ kg | FASSCO-Id. Qualität/Quality/Calid. | €/Stück Pce./Pce./Pza. |
|----------------------------------|--|------------------------------|---------|---------------------------------------|---------------------------|
| M 49 JUD 490 | 610 x 85 x 8 | 5/M10 | 2,85 | 044.12F220 | * |
| | | | | 044.12F3000 | * |
| M 50 M 52 Hy | 610 x 80 x 7 (3162) | 5/M10 | 2,35 | 044.02F220 | * |
| | | | | 044.02F3000 | * |
| M 61 | 700 x 90 x 8 (3962) | 7/M10 | 3,48 | 044.06F220 | * |
| | | | | 044.06F3000 | * |
| JUD 660 | 780 x 100 x 8 | 5/M12 | 4,25 | 082.01F220 | * |
| | | | | 082.01F3000 | * |
| M 67 Hydraster | 790 x 90 x 8 (10092) | 8/M10 | 3,90 | 044.13F220 | * |
| | | | | 044.13F3000 | * |
| M 67 | 840 x 100 x 8 (3122) | 7/M10 | 4,65 | 044.05F220 | * |
| | | | | 044.05F3000 | * |
| M 72/76 Challenger | 940 x 100 x 8 (8257) | 7/M10 | 5,20 | 044.01F220 | * |
| | | | | 044.01F3000 | * |
| 76/78 FEIDA | 940 x 127 x 12,7 (78-01-07) | 16/M12 + MWE | 10,50 | 013.01F220 | * |
| | | | | 013.01F3000 | * |
| M 76 neu | 960 x 120 x 12 | 16/M12 | 9,60 | 044.10F220 | * |
| | | | | 044.10F3000 | * |
| 78 FEIDA | 970 x 127 x 12,7 (78-01-07a) | 16/M12 +MWE | 10,80 | 013.06F220 | * |
| | | | | 013.06F3000 | * |
| M 80 M 82 | 1000 x 120 x 10 (1056) | 7/M10 | 8,30 | 044.07F220 | * |
| | | | | 044.07F3000 | * |
| M 82/84 Challenger | 1000 x 120 x 12 (5692) | 20/M10 | 10,00 | 044.03F220 | * |
| | | | | 044.03F3000 | * |
| 92 FEIDA | 1080 x 127 x 12,7 (92-01-05) | 18/M12 + MWE | 12,05 | 013.02F220 | * |
| | | | | 013.02F3000 | * |
| 92 COMO | 1155 x 127 x 12,65 (8442) | 24/M10 + MWE | 12,85 | 031.22F220 | * |
| | | | | 031.22F3000 | * |
| M 106 | 1240 x 130 x 12 (2104) | 18/M10 | 13,40 | 044.08F220 | * |
| | | | | 044.08F3000 | * |
| M 106 M 108/110 Challenger | 1300 x 130 x 12 (2104) | 18/M10 | 14,05 | 044.04F220 | * |
| | | | | 044.04F3000 | * |
| 115 FEIDA | 1390 x 160 x 12,7 (115-01-21) | 22/M12 + MWE | 19,60 | 013.03F220 | * |
| | | | | 013.03F3000 | * |
| 137 FEIDA | 1605 x 160 x 12,7 (137-01-3) | 26/M12 + MWE | 22,65 | 013.04F220 | * |
| | | | | 013.04F3000 | * |
| 155 FEIDA | 1790 x 160 x 12,7 (155-01-23) | 28/M12 + MWE | 25,25 | 013.05F220 | * |
| | | | | 013.05F3000 | * |



JURINE

| Maschinen-Typ Type/Type/Tipo | Abmessungen in mm Size/Dimension/Tamaño | Löcher/Holes Trous/Huecos | ⚖ kg | FASSCO-Id. Qualität/Quality/Calid. | €/Stück Pce./Pce./Pza. |
|---------------------------------|--|------------------------------|---------|---------------------------------------|---------------------------|
| 80 (*) | 995 x 130 x 10 | | 8,96 | 061.06F220 | * |
| | | | | 061.06F3000 | * |
| 82 | 1025 x 130 x 10 | 20/M10 | 9,25 | 061.01F220 | * |
| | | | | 061.01F3000 | * |
| 106 | 1275 x 130 x 10 | 12/M10 | 11,50 | 061.05F220 | * |
| | | | | 061.05F3000 | * |
| 106 | 1290 x 130 x 10 | 24/M10 | 11,55 | 061.02F220 | * |
| | | | | 061.02F3000 | * |
| 125 neu/new | 1480 x 130 x 10 | 28/M10 | 13,30 | 061.03F220 | * |
| | | | | 061.03F3000 | * |
| 125 (*) alt/old | 1550 x 130 x 12 | 30/M10 | 16,75 | 061.04F220 | * |
| | | | | 061.04F3000 | * |

(*Für diese JURINE-Typen ist eine Zeichnung erforderlich.

(*For these JURINE-types a drawing is required.

KASFOLD

| Maschinen-Typ Type/Type/Tipo | Abmessungen in mm Size/Dimension/Tamaño | Löcher/Holes Trous/Huecos | ⚖ kg | FASSCO-Id. Qualität/Quality/Calid. | €/Stück Pce./Pce./Pza. |
|---------------------------------|--|------------------------------|---------|---------------------------------------|---------------------------|
| Trimmer | Obermesser 375 x 140/70 x 10 | 8/7Ø 2/M8 | 2,05 | 136.90/001F236 | * |
| | Untermesser 380 x 33 x 15 | 4 zyl.vers. Langlöcher | 1,35 | 136.90/101F236 | * |



KATSUTA

| Maschinen-Typ Type/Type/Tipo | Abmessungen in mm Size/Dimension/Tamaño | Löcher/Holes Trous/Huecos | ⚖ kg | FASSCO-Id. Qualität/Quality/Calid. | €/Stück Pce./Pce./Pza. |
|---------------------------------|--|------------------------------|---------|---------------------------------------|---------------------------|
| S 220-HA | 850 x 130 x 9,5 | 16 3/8"W | 7,25 | 051.01F220 | * |
| | | | | 051.01F3000 | * |
| S 230-HOP | 900 x 130 x 9,5 | 18 3/8"W | 7,70 | 051.02F220 | * |
| | | | | 051.02F3000 | * |
| | 950 x 130 x 9,5 | 18 3/8"W | 8,15 | 051.10F220 | * |
| | | | | 051.10F3000 | * |
| S 290-HOP | 1130 x 140 x 11,1 | 22 3/8"W | 12,20 | 051.03F220 | * |
| | | | | 051.03F3000 | * |
| S 290-HOP | 1130 x 140 x 11,1 | 24/M10 | 12,20 | 051.14F220 | * |
| | | | | 051.14F3000 | * |
| | 1145 x 130 x 9,5 | 18 3/8"W | 9,80 | 051.11F220 | * |
| | | | | 051.11F3000 | * |

Für alle KATSUTA-Typen ist eine Zeichnung erforderlich.

For all KATSUTE-types a drawing is required.

Fortsetzung nächste Seite

KATSUTA



| Maschinen-Typ Type/Type/Tipo | Abmessungen in mm Size/Dimension/Tamaño | Löcher/Holes Trous/Huecos | kg | FASSCO-Id. Qualität/Quality/Calid. | €/Stück Pce./Pce./Pza. |
|-------------------------------------|--|------------------------------|-------|---------------------------------------|---------------------------|
| S 330-HOP | 1220 x 140 x 11,1 | 22 3/8"W | 13,15 | 051.04F220 | * |
| | | | | 051.04F3000 | * |
| S 330-HOP | 1220 x 140 x 12,7 | 22 3/8"W | 15,05 | 051.07F220 | * |
| | | | | 051.07F3000 | * |
| S 330-HOP | 1250 x 140 x 12,7 | 28/M10 | 15,60 | 051.12F220 | * |
| | | | | 051.12F3000 | * |
| S 330-HOW | 1300 x 150 x 12,7 | 24 3/8"W | 17,20 | 051.08F220 | * |
| | | | | 051.08F3000 | * |
| | 1400 x 150 x 12,7 | 26 3/8"W | 18,50 | 051.09F220 | * |
| | | | | 051.09F3000 | * |
| S 380-HOW FRIEND | 1450 x 150 x 12,7 | 26 3/8"W | 19,20 | 051.05F220 | * |
| | | | | 051.05F3000 | * |
| SN 380-HOW SH 380-HOP 430-HOW | 1420 x 160 x 13,7 | 34/M12 | 21,60 | 051.06F220 | * |
| | | | | 051.06F3000 | * |

Für alle KATSUTA-Typen ist eine Zeichnung erforderlich.
For all KATSUTA-types a drawing is required.

KAYM



| Maschinen-Typ Type/Type/Tipo | Abmessungen in mm Size/Dimension/Tamaño | Löcher/Holes Trous/Huecos | kg | FASSCO-Id. Qualität/Quality/Calid. | €/Stück Pce./Pce./Pza. |
|---------------------------------|--|------------------------------|-------|---------------------------------------|---------------------------|
| 58 | 730 x 100 x 8 | | 4,10 | 126.01F220 | * |
| | | | | 126.01F3000 | * |
| 72 | 900 x 120 x 8 | | 5,95 | 126.02F220 | * |
| | | | | 126.02F3000 | * |
| 72 ab 07/2003 | 900 x 120 x 8 | 7/M10 | 5,95 | 126.07F220 | * |
| | | | | 126.07F3000 | * |
| 78 | 900 x 120 x 10 | | 7,95 | 126.03F220 | * |
| | | | | 126.03F3000 | * |
| 85 | 1050 x 120 x 10 | | 8,75 | 126.04F220 | * |
| | | | | 126.04F3000 | * |
| 92 | 1095 x 115 x 11,7 | | 10,30 | 126.05F220 | * |
| | | | | 126.05F3000 | * |
| 115 | 1400 x 140 x 12 | | 16,30 | 126.06F220 | * |
| | | | | 126.06F3000 | * |

Für alle KAYM-Typen ist eine Zeichnung erforderlich.
For all KAYM-types a drawing is required.



KOLBUS

| Maschinen-Typ Type/Type/Tipo | Abmessungen in mm Size/Dimension/Tamaño | Löcher/Holes Trous/Huecos | △ kg | FASSCO-Id. Qualität/Quality/Calid. | €/Stück Pce./Pce./Pza. |
|--|--|------------------------------|---------|---------------------------------------|---------------------------|
| HD (5/85) HD 49 / FD 49 HD 100/130/140 | Vordermesser 15-3-372 | 10/M12 | 4,30 | 062.90/001F220 | 154,00 |
| | 560 x 115 x 10 | | | 062.90/001F3000 | 175,00 |
| HD 142/150/152 HD 143 P HDS 150/151 | Seitenmesser, links 15-3-446 | 9/M12 | 2,60 | 062.93/023F220 | 154,00 |
| | 405 x 115 x 10 | | | 062.93/023F3000 | 170,00 |
| HD 153 MD 55 MDS | Seitenmesser, rechts 15-3-446 | 9/M12 | 2,60 | 062.93/023F220 | 154,00 |
| | 405 x 115 x 10 | | | 062.93/023F3000 | 170,00 |
| €/Satz/Set/Jeu/Juego | | | | | |
| HD (5/85) HDS/MD/MDS | kompletter Satz complete set | = 3 Messer = 3 knives | 9,50 | 062.93/300F220 | 462,00 |
| | | | | 062.93/300F3000 | 515,00 |

| Maschinen-Typ Type/Type/Tipo | Abmessungen in mm Size/Dimension/Tamaño | Löcher/Holes Trous/Huecos | △ kg | FASSCO-Id. Qualität/Quality/Calid. | €/Stück Pce./Pce./Pza. |
|---------------------------------|--|------------------------------|---------|---------------------------------------|---------------------------|
| HD 150 alt/old | Vordermesser 15-3-372 560 x 115 x 10 | 10/M12 | 4,30 | 062.90/001F220 | * |
| | | | | 062.90/001F3000 | * |
| | Seitenmesser, links 15-3-371 445 x 115 x 10 | 6/M12 | 3,10 | 062.90/002F220 | * |
| | | | | 062.90/002F3000 | * |
| | Seitenmesser, rechts 15-3-370 445 x 115 x 10 | 6/M12 | 3,10 | 062.90/003F220 | * |
| | | | | 062.90/003F3000 | * |
| €/Satz/Set/Jeu/Juego | | | | | |
| HD 150 alt/old | kompletter Satz complete set | = 3 Messer = 3 knives | 10,50 | 062.90/300F220 | * |
| | | | | 062.90/300F3000 | * |

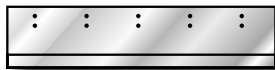

KOLBUS

| Maschinen-Typ Type/Type/Tipo | Abmessungen in mm Size/Dimension/Tamaño | Löcher/Holes Trous/Huecos | △ kg | FASSCO-Id. Qualität/Quality/Calid. | €/Stück Pce./Pce./Pza. |
|---------------------------------|--|------------------------------|---------|---------------------------------------|---------------------------|
| HD alt/old | Vordermesser 15-3-372 560 x 115 x 10 | 10/M12 | 4,30 | 062.90/001F220 | * |
| | | | | 062.90/001F3000 | * |
| | Seitenmesser, links 15-3-371 440 x 115 x 10 | 6/M12 (3/M10)* | 3,10 | 062.92/002F220 | * |
| | | | | 062.92/002F3000 | * |
| | Seitenmesser, rechts 15-3-370 440 x 115 x 10 | 6/M12 (3/M10)* | 3,10 | 062.92/003F220 | * |
| | | | | 062.92/003F3000 | * |
| €/Satz/Set/Jeu/Juego | | | | | |
| HD alt/old | kompletter Satz complete set | = 3 Messer = 3 knives | 10,50 | 062.92/300F220 | * |
| | | | | 062.92/300F3000 | * |

*Nur auf besondere Bestellung, bei Stahlmessern nicht erforderlich.

*On special request only, not necessary for steel knives.

KOLBUS

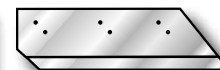

| Maschinen-Typ Type/Type/Tipo | Abmessungen in mm Size/Dimension/Tamaño | Löcher/Holes Trous/Huecos | ⚖️ kg | FASSCO-Id. Qualität/Quality/Calid. | €/Stück Pce./Pce./Pza. |
|---|---|------------------------------|----------|---------------------------------------|---------------------------|
| MD 155 baugleich/ conformable Perfecta SDY-EZ | Vordermesser 48.22.024 540 x 115 x 10 | 8/M12x1,5 | 4,25 | 005.95/001F220 | 172,00 |
| | | | | 005.95/001F3000 | 224,00 |
| | Seitenmesser, links 48.22.024 420 x 115 x 10 | 6/M12x1,5 | 2,85 | 005.95/002F220 | 139,00 |
| | | | | 005.95/002F3000 | 181,00 |
| | Seitenmesser, rechts 48.22.024 420 x 115 x 10 | 6/M12x1,5 | 2,85 | 005.95/003F220 | 139,00 |
| | | | | 005.95/003F3000 | 181,00 |
| €/Satz/Set/Jeu/Juego | | | | | |
| MD 155 | kompletter Satz complete set | = 3 Messer = 3 knives | 9,95 | 005.95/300F220 | 450,00 |
| | | | | 005.95/300F3000 | 586,00 |

KOLBUS

| Maschinen-Typ Type/Type/Tipo | Abmessungen in mm Size/Dimension/Tamaño | Löcher/Holes Trous/Huecos | ⚖️ kg | FASSCO-Id. Qualität/Quality/Calid. | €/Stück Pce./Pce./Pza. |
|---------------------------------|--|------------------------------|----------|---------------------------------------|---------------------------|
| | Rückenstützmesser 12153518 194 x 25 x 4 mm | 3 vers.Lö. | 0,17 | 466.0102.004.F431 | * |

KOMORI

| Maschinen-Typ Type/Type/Tipo | Abmessungen in mm Size/Dimension/Tamaño | Löcher/Holes Trous/Huecos | ⚖️ kg | FASSCO-Id. Qualität/Quality/Calid. | €/Stück Pce./Pce./Pza. |
|---------------------------------|--|------------------------------|----------|---------------------------------------|---------------------------|
| 115 | 1350 x 140 x 12 | 30/M12x1,5 +MWE | 15,60 | 158.01F220 | 427,00 |
| | | | | 158.01F3000 | 640,00 |
| 132 | 1515 x 140 x 12 | 30/M12x1,5 +MWE | 17,45 | 158.02F220 | 469,00 |
| | | | | 158.02F3000 | 700,00 |



KRAUSE - BIAGOSCH

| Maschinen-Typ Type/Type/Tipo | Abmessungen in mm Size/Dimension/Tamaño | Löcher/Holes Trous/Huecos | ⚖️ kg | FASSCO-Id. Qualität/Quality/Calid. | €/Stück Pce./Pce./Pza. |
|---------------------------------|--|------------------------------|----------|---------------------------------------|---------------------------|
| A 36 B | 362 x 70 x 5,75 (E 1640) | 4 vers. Lö. | 1,00 | 003.08F220 | * |
| | | | | 003.08F3000 | * |
| A 52 B/Bm | 666 x 95 x 7,75 (E 5993b) | 4/M10 | 3,35 | 003.01F220 | * |
| | | | | 003.01F3000 | * |
| A 68 B | 830 x 94,5 x 7,75 (E 1583) | 5/M10 | 4,20 | 003.02F220 | * |
| | | | | 003.02F3000 | * |
| A 70 B | 850 x 95 x 7,75 (E 11015) | 5/M10 | 4,33 | 003.06F220 | * |
| | | | | 003.06F3000 | * |
| A 72 B/Bm | 866 x 94,5 x 7,75 (D 5755b) | 5/M10 | 4,35 | 003.03F220 | * |
| | | | | 003.03F3000 | * |
| A 72 OH | 870 x 100 x 9,75 (D 5773a) | 12/M10 | 5,70 | 003.09F220 | * |
| | | | | 003.09F3000 | * |
| A 72 Serie 9/82 | 910 x 140 x 10 (AV 2D7847) | 7/M10 | 8,85 | 003.11F220 | * |
| | | | | 003.11F3000 | * |
| A 76 N A 78 N | 920 x 112 x 9,75 (D 3779) | 7/M10 | 6,70 | 003.05F220 | * |
| | | | | 003.05F3000 | * |
| A 76 Serie 9/82 | 950 x 140 x 10 (AV 2D7990) | 9/M10 | 9,20 | 003.15F220 | * |
| | | | | 003.15F3000 | * |
| A 80 Mh A 82 Mh/Combi | 960 x 130 x 10 (H 2D6036) | 10/M10 | 8,65 | 003.07F220 | * |
| | | | | 003.07F3000 | * |
| A 86 Mh A 88 Mh/Combi | 1040 x 130 x 11,8 (D 2D5283a) | 11/M12 | 11,10 | 003.10F220 | * |
| | | | | 003.10F3000 | * |
| A 92 Serie 8/83 | 1100 x 140 x 10 (AW 2D8051) | 9/M10 (T-120) | 10,70 | 003.16F220 | * |
| | | | | 003.16F3000 | * |
| A 92 Serie 9/82 | 1110 x 140 x 10 (AV 2D7824) | 9/M10 (T-125) | 10,75 | 003.13F220 | * |
| | | | | 003.13F3000 | * |
| A 106 Mh/Mhn A 107 Mh/Mhn | 1250 x 130 x 13 (G 2D5457) | 13/M12 | 14,65 | 003.14F220 | * |
| | | | | 003.14F3000 | * |
| A 115 | 1390 x 140 x 14 (CB 4B2505) | 20/M12 + MWE | 18,90 | 003.17F220 | * |
| | | | | 003.17F3000 | * |



KRAUSE - BIAGOSCH

Einmesser-Dreischneider

| Maschinen-Typ Type/Type/Tipo | Abmessungen in mm Size/Dimension/Tamaño | Löcher/Holes Trous/Huecos | ⚖️ kg | FASSCO-Id. Qualität/Quality/Calid. | €/Stück Pce./Pce./Pza. |
|---------------------------------|--|------------------------------|----------|---------------------------------------|---------------------------|
| A 30/43 D | 720 x 110 x 9,75 (A 4D5043) | 12/M12 | 5,35 | 003.90F220 | * |
| | | | | 003.90F3000 | * |

KRAVEC



| Maschinen-Typ Type/Type/Tipo | Abmessungen in mm Size/Dimension/Tamaño | Löcher/Holes Trous/Huecos | ⚖️ kg | FASSCO-Id. Qualität/Quality/Calid. | €/Stück Pce./Pce./Pza. |
|---------------------------------|--|------------------------------|----------|---------------------------------------|---------------------------|
| 84 | 995 x 105 x 12 | 12/M10 | 8,65 | 129.01F220 | * |
| | | | | 129.01F3000 | * |
| 97 | 1106 x 105 x 12 | 16/M10 | 9,65 | 129.02F220 | * |
| | | | | 129.02F3000 | * |
| | 1357 x 105 x 12 | 18/M10 | 11,80 | 129.04F220 | * |
| | | | | 129.04F3000 | * |
| 115 | 1360 x 150 x 12 | 20/M10 | 11,80 | 129.05F220 | * |
| | | | | 129.05F3000 | * |

Für alle KRAVEC-Typen ist eine Zeichnung erforderlich.
For all KRAVEC-types a drawing is required.

KRUG & PRIESTER/IDEAL

(Michael Business Machines / Triumph)

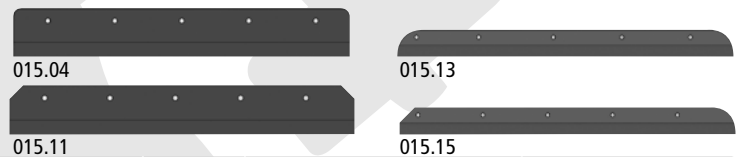

| Maschinen-Typ Type/Type/Tipo | Abmessungen in mm Size/Dimension/Tamaño | Löcher/Holes Trous/Huecos | ⚖️ kg | FASSCO-Id. Qualität/Quality/Calid. | €/Stück Pce./Pce./Pza. |
|--|--|--------------------------------|----------|---------------------------------------|---------------------------|
| FORTE 24 F 24 | 295 x 32 x 6 | 4 vers. Langlöcher | 0,30 | 015.06F220 | 99,00 |
| FORTE 3600 FORTE 3610 | 425 x 39 x 6 | 6 vers. Langlöcher | 0,58 | 015.01F220 | 89,00 |
| IDEAL 3905 3915/3915-95 | 444 x 39 x 6 (9000 115 3) | 5/M6 | 0,62 | 015.12F220 | 89,00 |
| IDEAL 3900 | 445 x 39 x 6 (9000 110 4) | 6 vers. Langlöcher | 0,61 | 015.10F220 | 97,00 |
| FORTE 38 F 38 E | 455 x 58 x 6 | 6 vers. Langlöcher | 1,02 | 015.05F220 | 127,00 |
| IDEAL 4205 IDEAL 4215 | 487 x 39 x 6 (9000 121) | 5/M6 (T/93,5) (1xR, 1xE) | 0,65 | 015.15F220 | 93,00 |
| IDEAL 4305 IDEAL 4315 IDEAL 4350 | 487 x 39 x 6 (9000 120 3) | 5/M6 (T/98,8) (2x R) | 0,65 | 015.13F220 | 93,00 |
| FORTE 45 F 45 | 570 x 88 x 8 | 5 vers. Langlöcher | 2,60 | 015.02F220 | 161,00 |
| | | | | 015.02F3000 | 215,00 |
| IDEAL 4700/4705/4800 4810/4850 4810/4850-95 | 570 x 90 x 10 (9000 021 2) | 5/M10 | 3,45 | 015.07F220 | 128,00 |
| | | | | 015.07F3000 | 189,00 |
| FORTE 52 F 52 E | 630 x 88 x 8 | 5 vers. Langlöcher | 2,90 | 015.03F220 | 170,00 |
| | | | | 015.03F3000 | 227,00 |
| IDEAL 5210/5250 | 630 x 90 x 10 (E/Ra) (9000 023 4) | 5/M10 (T/125) | 3,75 | 015.04F220 | 135,00 |
| | | | | 015.04F3000 | 195,00 |
| IDEAL 5220/5221/5222 5210-94/5210- 95 5221/5250 5221-05 EP DIGICUT | 630 x 90 x 10 (E/45°) (9000 130 2) | 5/M10 (T/118,75) | 3,75 | 015.11F220 | 135,00 |
| | | | | 015.11F3000 | 195,00 |

KRUG & PRIESTER/IDEAL

(Michael Business Machines / Triumph)



| Maschinen-Typ Type/Type/Tipo | Abmessungen in mm Size/Dimension/Tamaño | Löcher/Holes Trous/Huecos | △ kg | FASSCO-Id. Qualität/Quality/Calid. | €/Stück Pce./Pce./Pza. |
|----------------------------------|--|------------------------------|---------|---------------------------------------|---------------------------|
| IDEAL 6550 6550-95 | 756 x 90 x 10 (9000 025 2) | 5/M10 | 4,40 | 015.08F220 | 157,00 |
| | | | | 015.08F3000 | 235,00 |
| IDEAL 7228 7228-95 7228-06 | 840 x 100 x 10 (9000 038 3) (9000 141) | 6/M10 | 5,50 | 015.09F220 | 205,00 |
| | | | | 015.09F3000 | 280,00 |



KWANG LONG (POWERCUT)

| Maschinen-Typ Type/Type/Tipo | Abmessungen in mm Size/Dimension/Tamaño | Löcher/Holes Trous/Huecos | △ kg | FASSCO-Id. Qualität/Quality/Calid. | €/Stück Pce./Pce./Pza. |
|-----------------------------------|--|------------------------------|---------|---------------------------------------|---------------------------|
| SA-94 SP-37 94-CNC | 1092 x 127 x 9,52 43" x 5" x .375" | 20 3/8"W | 9,10 | 079.01F220 | * |
| | | | | 079.01F3000 | * |
| 115-CNC 115-SD Powercut 115 | 1346 x 139,7 x 12 53" x 5.1/2" x .472" | 24 7/16"W +MWE | 15,65 | 079.02F220 | * |
| | | | | 079.02F3000 | * |



LAWSON

| Maschinen-Typ Type/Type/Tipo | Abmessungen in mm Size/Dimension/Tamaño | Löcher/Holes Trous/Huecos | △ kg | FASSCO-Id. Qualität/Quality/Calid. | €/Stück Pce./Pce./Pza. |
|---------------------------------|---|------------------------------|---------|---------------------------------------|---------------------------|
| 30" 76 MMC | 1000 x 120 x 12 39.37" x 4.72" x .472" (2DA-5000) | 18/M10 | 10,00 | 048.20F220 | * |
| | | | | 048.20F3000 | * |
| 36" 92 MMC | 1155 x 127 x 12,5 45.47" x 5" x .492" (2DB-5000) | 24/M10 | 12,70 | 048.21F220 | * |
| | | | | 048.21F3000 | * |
| 38"/ 39" | 1219,2 x 127 x 12,6 48" x 5" x .496" (2AA2) | 24 1/2"-13 | 13,55 | 048.01F220 | * |
| | | | | 048.01F3000 | * |
| 2" | 1346,2 x 127 x 12,6 53" x 5" x .496" (2BA4016) | 27 1/2"-13 | 14,95 | 048.02F220 | * |
| | | | | 048.02F3000 | * |
| 46" | 1473,2 x 127 x 12,6 58" x 5" x .496" (2AB2-A) | 30 1/2"-13 | 16,35 | 048.03F220 | * |
| | | | | 048.03F3000 | * |
| 46" | 1473,2 x 127 x 12,6 58" x 5" x .496" (2BB4016) | 30 1/2"-13 | 16,35 | 048.14F220 | * |
| | | | | 048.14F3000 | * |
| 52" | 1574,8 x 127 x 12,6 62" x 5" x .496" (2AC2) | 30 1/2"-13 | 17,50 | 048.04F220 | * |
| | | | | 048.04F3000 | * |

LAWSON



| Maschinen-Typ Type/Type/Tipo | Abmessungen in mm Size/Dimension/Tamaño | Löcher/Holes Trous/Huecos | △ kg | FASSCO-Id. Qualität/Quality/Calid. | €/Stück Pce./Pce./Pza. |
|---------------------------------|--|------------------------------|---------|---------------------------------------|---------------------------|
| 52" | 1600,2 x 127 x 12,6 63" x 5" x .496" (2AC4006) | 33 1/2"-13 | 17,80 | 048.05F220 | * |
| | | | | 048.05F3000 | * |
| 55" | 1676,4 x 127 x 12,6 66" x 5" x .496" | 33 1/2"-13 | 18,65 | 048.08F220 | * |
| | | | | 048.08F3000 | * |
| 60" | 1828,8 x 127 x 12,6 72" x 5" x .496" (2AE4000) | 36 1/2"-13 | 20,30 | 048.15F220 | * |
| | | | | 048.15F3000 | * |
| 66" | 1955,8 x 127 x 12,6 77" x 5" x .496" | 39 1/2"-13 | 21,70 | 048.16F220 | * |
| | | | | 048.16F3000 | * |
| 69" | 2032 x 127 x 12,6 80" x 5" x .496" (2AG4000) | 39 1/2"-13 | 22,55 | 048.10F220 | * |
| | | | | 048.10F3000 | * |

LAWSON

„PACEMAKER“



| Maschinen-Typ Type/Type/Tipo | Abmessungen in mm Size/Dimension/Tamaño | Löcher/Holes Trous/Huecos | △ kg | FASSCO-Id. Qualität/Quality/Calid. | €/Stück Pce./Pce./Pza. |
|--------------------------------------|---|------------------------------|---------|---------------------------------------|---------------------------|
| 47" Pacemaker III / IV | 1498,6 x 127 x 12,6 59" x 5" x .496" (2BB4001) | 30 1/2"-13 | 16,65 | 048.19F220 | * |
| | | | | 048.19F3000 | * |
| 52" Pacemaker II | 1600,2 x 127 x 12,6 63" x 5" x .496" (2BC4016) | 33 1/2"-13 | 17,80 | 048.06F220 | * |
| | | | | 048.06F3000 | * |
| 52" Pacemaker II | 1625,6 x 127 x 12,6 64" x 5" x .496" (2BC4002) | 33 1/2"-13 | 18,00 | 048.07F220 | * |
| | | | | 048.07F3000 | * |
| 56" Pacemaker II | 1701,8 x 127 x 12,6 67" x 5" x .496" (2BD4016) | 33 1/2"-13 | 18,90 | 048.17F220 | * |
| | | | | 048.17F3000 | * |
| 59" Pacemaker II | 1828,8 x 127 x 12,6 72" x 5" x .496" (2BE4040) | 36 1/2"-13 | 20,30 | 048.18F220 | * |
| | | | | 048.18F3000 | * |
| 60"/60T80 Pacemaker II | 1854,2 x 127 x 12,6 73" x 5" x .496" (2BE5046) | 36 1/2"-13 | 20,60 | 048.09F220 | * |
| | | | | 048.09F3000 | * |
| 69" Pacemaker II | 2108,2 x 127 x 12,6 83" x 5" x .496" (2BG4005) | 42 1/2"-13 | 23,40 | 048.11F220 | * |
| | | | | 048.11F3000 | * |
| 87"/ 87T100 Pacemaker III / IV | 2590,8 x 127 x 12,6 102" x 5" x .496" (2BH4000) | 51 1/2"-13 | 28,75 | 048.12F220 | * |
| | | | | 048.12F3000 | * |
| 110" Pacemaker III / IV | 3175,0 x 127 x 12,6 125" x 5" x .496" (2BK4004) | 63 1/2"-13 | 35,25 | 048.13F220 | * |
| | | | | 048.13F3000 | * |



LAWSON

„REGENT CUTTER“

| Maschinen-Typ Type/Type/Tipo | Abmessungen in mm Size/Dimension/Tamaño | Löcher/Holes Trous/Huecos | △ kg | FASSCO-Id. Qualität/Quality/Calid. | €/Stück Pce./Pce./Pza. |
|---------------------------------|--|------------------------------|---------|---------------------------------------|---------------------------|
| 30" 76 | 900 x 100 x 10 35.433" x 3.937" x .393" | 12 1/2"-13 | 6,05 | 048.67/420F220 | * |
| | | | | 048.67/420F3000 | * |
| 30" 76 | 900 x 100 x 10 35.433" x 3.937" x .393" | 16 1/2"-13 | 6,00 | 048.63/423F220 | * |
| | | | | 048.63/423F3000 | * |
| KB-32" 80/82 | 960 x 130 x 10 37.795" x 5.118" x .393" | 10 3/8"-16 | 8,65 | 048.50/307F220 | * |
| | | | | 048.50/307F3000 | * |
| 34-1/2" 86/88 | 1040 x 130 x 11,8 40.945" x 5.118" x .465" | 11 1/2"-13 | 11,10 | 048.51/310F220 | * |
| | | | | 048.51/310F-3000 | * |
| 35-3/8" 86/90 | 1060 x 125 x 12 41.732" x 4.921" x .472" | 10 1/2"-13 | 10,95 | 048.54/402F-220 | * |
| | | | | 048.54/402F3000 | * |
| 36" 92 | 1080 x 120 x 12 42.519" x 4.724" x .472" | 22 1/2"-13 | 10,40 | 048.65/424F220 | * |
| | | | | 048.65/424F3000 | * |
| 36" 92 | 1090 x 120 x 12 42.913" x 4.724" x .472" | 22 1/2"-13 | 10,50 | 048.60/425F220 | * |
| | | | | 048.60/425F3000 | * |
| 36" 92 | 1100 x 125 x 12 43.307" x 4.921" x .472" | 11 1/2"-13 | 11,30 | 048.62/419F220 | * |
| | | | | 048.62/419F3000 | * |
| W-42" 107 | 1280 x 140 x 13,75 50.394" x 5.512" x .541" | 13 1/2"-13 | 17,00 | 048.52/407F220 | * |
| | | | | 048.52/407F3000 | * |
| 44"/ 45-1/4" 112/115 | 1340 x 125 x 12 52.755" x 4.921" x .472" | 13 1/2"-13 | 13,65 | 048.55/409F220 | * |
| | | | | 048.55/409F3000 | * |
| 45-1/4" 115 | 1380 x 125 x 12 54.33" x 4.921" x .472" | 14 1/2"-13 +MWE | 14,15 | 048.58/418F220 | * |
| | | | | 048.58/418F3000 | * |
| 52" 132 | 1570 x 140 x 13,75 61.811" x 5.512" x .541" | 15 1/2"-13 | 20,80 | 048.53/411F220 | * |
| | | | | 048.53/411F3000 | * |
| 54" 137 | 1595 x 125 x 12 62.8" x 4.921" x .472" | 16 1/2"-13 +MWE | 16,40 | 048.61/421F220 | * |
| | | | | 048.61/421F3000 | * |
| 57-1/2"/ 59" 146/150 | 1720 x 140 x 14 67.716" x 5.512" x .551" | 17 1/2"-13 | 22,85 | 048.56/413F220 | * |
| | | | | 048.56/413F3000 | * |
| 61" 155 | 1780 x 140 x 14 70.078" x 5.512" x .551" (5032033) | 18 1/2"-13 +MWE | 23,65 | 048.59/417F220 | * |
| | | | | 048.59/417F3000 | * |
| 65"/66" 165/168 | 1920 x 140 x 16,75 75.591" x 5.512" x .659" | 19 1/2"-13 | 31,10 | 048.57/415F220 | * |
| | | | | 048.57/415F3000 | * |
| 71" 180 | 2055 x 160 x 16 80.906" x 6.299" x .629" | 20 1/2"-13 | 36,30 | 048.64/408F220 | * |
| | | | | 048.64/408F3000 | * |
| 73" 185 | 2105 x 160 x 16 82.874" x 6.299" x .629" | 20 1/2"-13 +MWE | 37,25 | 048.66/422F220 | * |
| | | | | 048.66/422F3000 | * |

I
J
K
L

LAWSON



| Maschinen-Typ Type/Type/Tipo | Abmessungen in mm Size/Dimension/Tamaño | Löcher/Holes Trous/Huecos | kg | FASSCO-Id. Qualität/Quality/Calid. | €/Stück Pce./Pce./Pza. |
|---------------------------------|--|------------------------------|-------|---------------------------------------|---------------------------|
| C/DM Trimmer RAPID 43/44 | Vordermesser 560 x 115 x 10 22" x 4.1/2" x .393" (RT343 Front) | 12 1/2"-13 | 4,20 | 048.90/001F220 | * |
| | | | | 048.90/001F3000 | * |
| | Seitenmesser, links 424 x 115 x 10 16.693" x 4.1/2" x .393" (RT340 Side) | 10 1/2"-13 | 3,10 | 048.90/023F220 | * |
| | | | | 048.90/023F3000 | * |
| | Seitenmesser, rechts 424 x 115 x 10 16.693" x 4.1/2" x .393" (RT340 Side) | 10 1/2"-13 | 3,10 | 048.90/023F220 | * |
| | | | | 048.90/023F3000 | * |
| €/Satz/Set/Jeu/Juego | | | | | |
| C/DM Trimmer RAPID 43/44 | kompletter Satz complete set | = 3 Messer = 3 knives | 10,40 | 048.90/300F220 | * |
| | | | | 048.90/300F3000 | * |

| Maschinen-Typ Type/Type/Tipo | Abmessungen in mm Size/Dimension/Tamaño | Löcher/Holes Trous/Huecos | kg | FASSCO-Id. Qualität/Quality/Calid. | €/Stück Pce./Pce./Pza. |
|---------------------------------|--|------------------------------|------|---------------------------------------|---------------------------|
| Trimmer RAPID 38 | Vordermesser 500 x 115 x 10 19.685" x 4.1/2" x .393" | 12 1/2"-13 | 3,75 | 048.94/001F220 | * |
| | | | | 048.94/001F3000 | * |
| | Seitenmesser, links 424 x 115 x 10 16.693" x 4.1/2" x .393" (RT340 Side) | 10 1/2"-13 | 3,10 | 048.90/023F220 | * |
| | | | | 048.90/023F3000 | * |
| | Seitenmesser, rechts 424 x 115 x 10 16.693" x 4.1/2" x .393" (RT340 Side) | 10 1/2"-13 | 3,10 | 048.90/023F220 | * |
| | | | | 048.90/023F3000 | * |
| €/Satz/Set/Jeu/Juego | | | | | |
| Trimmer RAPID 38 | kompletter Satz complete set | = 3 Messer = 3 knives | 9,95 | 048.91/300F220 | * |
| | | | | 048.91/300F3000 | * |

| Maschinen-Typ Type/Type/Tipo | Abmessungen in mm Size/Dimension/Tamaño | Löcher/Holes Trous/Huecos | kg | FASSCO-Id. Qualität/Quality/Calid. | €/Stück Pce./Pce./Pza. |
|---------------------------------|--|------------------------------|------|---------------------------------------|---------------------------|
| Trimmer RAPID 44FS100 | Vordermesser 500 x 115 x 10 19.685" x 4.1/2" x .393" | 12 1/2"-13 | 3,75 | 048.94/001F220 | * |
| | | | | 048.94/001F3000 | * |
| | Seitenmesser, links 390 x 115 x 10 15.354" x 4.1/2" x .393" | 10 1/2"-13 | 2,55 | 048.94/023F220 | * |
| | | | | 048.94/023F3000 | * |
| | Seitenmesser, rechts 390 x 115 x 10 15.354" x 4.1/2" x .393" | 10 1/2"-13 | 2,55 | 048.94/023F220 | * |
| | | | | 048.94/023F3000 | * |
| €/Satz/Set/Jeu/Juego | | | | | |
| Trimmer RAPID 44FS100 | kompletter Satz complete set | = 3 Messer = 3 knives | 8,85 | 048.94/300F220 | * |
| | | | | 048.94/300F3000 | * |



LAZER

(GRAFOPAT)

| Maschinen-Typ Type/Type/Tipo | Abmessungen in mm Size/Dimension/Tamaño | Löcher/Holes Trous/Huecos | △ kg | FASSCO-Id. Qualität/Quality/Calid. | €/Stück Pce./Pce./Pza. |
|---------------------------------|--|------------------------------|---------|---------------------------------------|---------------------------|
| G52/53 | 605 x 100 x 10 | 5/M10 | 4,20 | 120.01F220 | * |
| | | | | 120.01F3000 | * |
| G66 | 740 x 100 x 10 | 5/M10 | 5,13 | 120.02F220 | * |
| | | | | 120.02F3000 | * |
| G66/68 | 748 x 100 x 10 | 5/M10 | 5,15 | 120.04F220 | * |
| | | | | 120.04F3000 | * |
| G73 | 815 x 100 x 10 | 12/M10 | 5,70 | 120.03F220 | * |
| | | | | 120.03F3000 | * |



LHERMITE

| Maschinen-Typ Type/Type/Tipo | Abmessungen in mm Size/Dimension/Tamaño | Löcher/Holes Trous/Huecos | △ kg | FASSCO-Id. Qualität/Quality/Calid. | €/Stück Pce./Pce./Pza. |
|---------------------------------|--|------------------------------|---------|---------------------------------------|---------------------------|
| 70 *) | 855 x 130 x 8 | 7/M10 | 5,60 | 046.08F220 | * |
| | | | | 046.08F3000 | * |
| 82 R2A *) | 1015 x 135 x 12 | 9/M10 | 11,40 | 046.01F220 | * |
| | | | | 046.01F3000 | * |
| 82 | 1055 x 140 x 12 | 9/M10 | 11,60 | 046.07F220 | * |
| | | | | 046.07F3000 | * |
| 80 *) | 1070 x 140 x 8 | 9/M10 | 7,80 | 046.09F220 | * |
| | | | | 046.09F3000 | * |
| 106 | 1320 x 140 x 12 | 11/M10 | 14,60 | 046.02F220 | * |
| | | | | 046.02F3000 | * |
| 114 | 1420 x 140 x 12 | 12/M10 | 16,55 | 046.03F220 | * |
| | | | | 046.03F3000 | * |
| 132 | 1560 x 140 x 12 | 13/M10 | 17,40 | 046.04F220 | * |
| | | | | 046.04F3000 | * |
| 165 | 1930 x 160 x 15 | 34/M10 | 32,20 | 046.05F220 | * |
| | | | | 046.05F3000 | * |
| 200 *) | 2400 x 160 x 15 | 42/M10 | 40,00 | 046.06F220 | * |
| | | | | 046.06F3000 | * |

*Für diese LHERMITE-Typen ist eine Zeichnung erforderlich.

*For these LHERMITE-types a drawing is required.

LINOTYPE

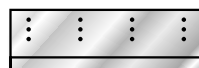

| Maschinen-Typ Type/Type/Tipo | Abmessungen in mm Size/Dimension/Tamaño | Löcher/Holes Trous/Huecos | kg | FASSCO-Id. Qualität/Quality/Calid. | €/Stück Pce./Pce./Pza. |
|---------------------------------|---|------------------------------|------|---------------------------------------|---------------------------|
| 2 A Trimstich | Vordermesser, oben 355,6 x 76,2 x 9,52 14" x 3" x .375" | 8 5/16"-18 | 1,70 | 075.90/001F3000 | * |
| | Seitenmesser, oben links 323,85 x 82,55 x 9,52 12.75" x 3.25" x .375" | 12 5/16"-18 | 1,75 | 075.90/002F3000 | * |
| | Seitenmesser, oben rechts 323,85 x 82,55 x 9,52 12.75" x 3.25" x .375" | 12 5/16"-18 | 1,75 | 075.90/003F3000 | * |
| | Vordermesser, unten 355,6 x 29 x 9,52 14" x 1.125" x .375" | 5 zyl. vers. Langlö. | 0,70 | 075.90/101F236 | * |
| | Seitenmesser, unten links 336,55 x 57,15 x 9,52 13.25" x 2.25" x .375" | 4 3/8"-16 | 1,40 | 075.90/123F236 | * |
| | Seitenmesser, unten rechts 336,55 x 57,15 x 9,52 13.25" x 2.25" x .375" | 4 3/8"-16 | 1,40 | 075.90/123F236 | * |
| €/Satz/Set/Jeu/Juego | | | | | |
| 2 A Trimstich | Satz Obermesser Set Upper knives | = 3 Messer = 3 knives | 5,20 | 075.90/300F3000 | * |
| | Satz Untermesser Set Bottom knives | = 3 Messer = 3 knives | 3,50 | 075.90/303F236 | * |

| Maschinen-Typ Type/Type/Tipo | Abmessungen in mm Size/Dimension/Tamaño | Löcher/Holes Trous/Huecos | kg | FASSCO-Id. Qualität/Quality/Calid. | €/Stück Pce./Pce./Pza. |
|---------------------------------|---|------------------------------|------|---------------------------------------|---------------------------|
| Trimstich | Vordermesser, oben 355,6 x 76,2 x 9,52 14" x 3" x .375" | 8 5/16"-18 | 1,70 | 075.90/001F3000 | * |
| | Seitenmesser, oben links 279,4 x 76,2 x 9,52 11" x 3" x .375" | 8 5/16"-18 | 1,40 | 075.91/023F3000 | * |
| | Seitenmesser, oben rechts 279,4 x 76,2 x 9,52 11" x 3" x .375" | 8 5/16"-18 | 1,40 | 075.91/023F3000 | * |
| | Vordermesser, unten 355,6 x 73 x 9,52 14" x 2.875" x .375" | 8 3/8"-16 | 1,70 | 075.91/101F236 | * |
| | Seitenmesser, unten links 336,55 x 57,15 x 9,52 13.25" x 2.25" x .375" | 4 3/8"-16 | 1,40 | 075.91/123F236 | * |
| | Seitenmesser, unten rechts 336,55 x 57,15 x 9,52 13.25" x 2.25" x .375" | 4 3/8"-16 | 1,40 | 075.91/123F236 | * |
| €/Satz/Set/Jeu/Juego | | | | | |
| Trimstich | Satz Obermesser Set Upper knives | = 3 Messer = 3 knives | 4,50 | 075.91/300F3000 | * |
| | Satz Untermesser Set Bottom knives | = 3 Messer = 3 knives | 4,50 | 075.91/303F236 | * |



| Maschinen-Typ Type/Type/Tipo | Abmessungen in mm Size/Dimension/Tamaño | Löcher/Holes Trous/Huecos | △ kg | FASSCO-Id. Qualität/Quality/Calid. | €/Stück Pce./Pce./Pza. |
|---------------------------------|--|---------------------------------|---------|---------------------------------------|---------------------------|
| 780 30" | 945 x 127 x 12,7 | 16/M12 4/6 Ø 2/M5 | 10,55 | 102.11F220 | * |
| | | | | 102.11F3000 | * |
| 780Z 30" | 945 x 127 x 12,7 | 16/M12 4/6 Ø 2/M5 +MWE | 10,55 | 102.16F220 | * |
| | | | | 102.16F3000 | * |
| 920 36" | 1100 x 127 x 12,7 | 18/M12 4/6 Ø | 12,30 | 102.02F220 | * |
| | | | | 102.02F3000 | * |
| 1150 45" | 1390 x 150 x 12,7 | 39/M12 4/6 Ø 2/M5 | 18,30 | 102.03F220 | * |
| | | | | 102.03F3000 | * |
| 1150 QZYW 45" | 1390 x 160 x 13,75 | 39/M12 4/6 Ø 2/M5 +MWE | 21,35 | 102.06F220 | * |
| | | | | 102.06F3000 | * |
| 1370 54" | 1605 x 160 x 13,75 | 30/M12 4/6 Ø 2/M5 | 24,50 | 102.14F220 | * |
| | | | | 102.14F3000 | * |
| 1370 54" | 1640 x 150 x 12,7 | 45/M12 4/6 Ø | 21,60 | 102.04F220 | * |
| | | | | 102.04F3000 | * |

Für alle LITONG-Typen ist eine Zeichnung erforderlich.
For all LITONG-types a drawing is required.



MACEY HARRIS / SHERIDAN



| Maschinen-Typ Type/Type/Tipo | Abmessungen in mm Size/Dimension/Tamaño | Löcher/Holes Trous/Huecos | △ kg | FASSCO-Id. Qualität/Quality/Calid. | €/Stück Pce./Pce./Pza. |
|--|--|------------------------------|----------------|---------------------------------------|---------------------------|
| 602, 630, 636 532/4, 542/8 543 454 | Vordermesser, oben B-600-0-1072 514,35 x 76,2 x 9,52 20.25" x 3" x .375" | 7 1/2"-13 4 1/4"-20 | 2,40 | 035.90/001F236 | 191,00 |
| | | | | 035.90/001F3000 | 221,00 |
| | Seitenmesser, oben links B-600-0-1071 200 1304 361,95 x 76,2 x 9,52 14.25" x 3" x .375" | 5 1/2"-13 4 1/4"-20 | 1,65 | 035.90/023F236 | 131,00 |
| | | | | 035.90/023F3000 | 159,00 |
| | Seitenmesser, oben rechts B-600-0-1071 200 1304 361,95 x 76,2 x 9,52 14.25" x 3" x .375" | 5 1/2"-13 4 1/4"-20 | 1,65 | 035.90/023F236 | 131,00 |
| | | | | 035.90/023F3000 | 159,00 |
| | Vordermesser, unten B-600-0-1068 520,7 x 25 x 12,7 20.5" x .984" x .500" | 7 Langlöcher | 1,10 | 035.90/101F236 | 144,00 |
| Seitenmesser, unten links B-600-0-1067 381 x 25 x 12,7 15" x .984" x .500" | 5 Langlöcher | 0,80 | 035.90/123F236 | 111,00 | |
| Seitenmesser, unten rechts B-600-0-1067 381 x 25 x 12,7 15" x .984" x .500" | 5 Langlöcher | 0,80 | 035.90/123F236 | 111,00 | |
| €/Satz/Set/Jeu/Juego | | | | | |
| 602, 630, 636 532/4, 542/8 543 454 | Satz Obermesser Set Upper knives | = 3 Messer = 3 knives | 5,70 | 035.90/300F236 | 453,00 |
| | Satz Obermesser Set Upper knives | = 3 Messer = 3 knives | 5,70 | 035.90/300F3000 | 539,00 |
| | Satz Untermesser Set Bottom knives | = 3 Messer = 3 knives | 2,70 | 035.90/303F236 | 366,00 |



MACEY HARRIS / SHERIDAN

| Maschinen-Typ Type/Type/Tipo | Abmessungen in mm Size/Dimension/Tamaño | Löcher/Holes Trous/Huecos | △ kg | FASSCO-Id. Qualität/Quality/Calid. | €/Stück Pce./Pce./Pza. |
|--|--|------------------------------|----------------|---------------------------------------|---------------------------|
| 640, 642 SP650, 652 SP690 SP705, SP562 | Vordermesser, oben B-640-0-1504 200 1303 558,8 x 76,2 x 9,52 22" x 3" x .375" | 7 1/2"-13 4 1/4"-20 | 2,60 | 035.91/001F236 | 194,00 |
| | | | | 035.91/001F3000 | 227,00 |
| | Seitenmesser, oben links B-600-0-1071 200 1304 361,95 x 76,2 x 9,52 14.25" x 3" x .375" | 5 1/2"-13 4 1/4"-20 | 1,65 | 035.90/023F236 | 131,00 |
| | | | | 035.90/023F3000 | 159,00 |
| | Seitenmesser, oben rechts B-600-0-1071 200 1304 361,95 x 76,2 x 9,52 14.25" x 3" x .375" | 5 1/2"-13 4 1/4"-20 | 1,65 | 035.90/023F236 | 131,00 |
| | | | | 035.90/023F3000 | 159,00 |
| | Vordermesser, unten B-640-0-1506 558,8 x 25 x 12,7 22" x .984" x .500" | 7 Langlöcher | 1,20 | 035.91/101F236 | 148,00 |
| Seitenmesser, unten links B-600-0-1067 381 x 25 x 12,7 15" x .984" x .500" | 5 Langlöcher | 0,80 | 035.90/123F236 | 111,00 | |
| Seitenmesser, unten rechts B-600-0-1067 381 x 25 x 12,7 15" x .984" x .500" | 5 Langlöcher | 0,80 | 035.90/123F236 | 111,00 | |
| €/Satz/Set/Jeu/Juego | | | | | |
| 640, 642 SP650, 652 SP690 SP705, SP562 | Satz Obermesser Set Upper knives | = 3 Messer = 3 knives | 5,90 | 035.91/300F236 | 456,00 |
| | Satz Obermesser Set Upper knives | = 3 Messer = 3 knives | 5,90 | 035.91/300F3000 | 545,00 |
| | Satz Untermesser Set Bottom knives | = 3 Messer = 3 knives | 2,80 | 035.91/303F236 | 370,00 |

M

MACEY HARRIS / SHERIDAN (Omega)



| Maschinen-Typ Type/Type/Tipo | Abmessungen in mm Size/Dimension/Tamaño | Löcher/Holes Trous/Huecos | ⚖️ kg | FASSCO-Id. Qualität/Quality/Calid. | €/Stück Pce./Pce./Pza. |
|--|--|------------------------------|----------|---------------------------------------|---------------------------|
| OMEGA Multibinder 450, 455 Heidelberg Prosetter | Vordermesser, oben B-600-0-1071 200 1304 361,95 x 76,2 x 9,52 14.25" x 3" x .375" | 5 1/2"-13 4 1/4"-20 | 1,65 | 035.90/023F236 | 131,00 |
| | | | | 035.90/023F3000 | 159,00 |
| | Seitenmesser, oben links B-600-0-1071 200 1304 361,95 x 76,2 x 9,52 14.25" x 3" x .375" | 5 1/2"-13 4 1/4"-20 | 1,65 | 035.90/023F236 | 131,00 |
| | | | | 035.90/023F3000 | 159,00 |
| | Seitenmesser, oben rechts B-600-0-1071 200 1304 361,95 x 76,2 x 9,52 14.25" x 3" x .375" | 5 1/2"-13 4 1/4"-20 | 1,65 | 035.90/023F236 | 131,00 |
| | | | | 035.90/023F3000 | 159,00 |
| | Vordermesser, unten B-600-0-1067 381 x 25 x 12,7 15" x .984" x .500" | 5 Langlöcher | 0,80 | 035.90/123F236 | 111,00 |
| | Seitenmesser, unten links B-600-0-1067 381 x 25 x 12,7 15" x .984" x .500" | 5 Langlöcher | 0,80 | 035.90/123F236 | 111,00 |
| | Seitenmesser, unten rechts B-600-0-1067 381 x 25 x 12,7 15" x .984" x .500" | 5 Langlöcher | 0,80 | 035.90/123F236 | 111,00 |
| €/Satz/Set/Jeu/Juego | | | | | |
| OMEGA Multibinder 450, 455 Heidelberg Prosetter | Satz Obermesser Set Upper knives | = 3 Messer = 3 knives | 4,95 | 035.92/300F236 | 393,00 |
| | Satz Obermesser Set Upper knives | = 3 Messer = 3 knives | 4,95 | 035.92/300F3000 | 477,00 |
| | Satz Untermesser Set Bottom knives | = 3 Messer = 3 knives | 2,40 | 035.92/303F236 | 333,00 |

| Maschinen-Typ Type/Type/Tipo | Abmessungen in mm Size/Dimension/Tamaño | Löcher/Holes Trous/Huecos | ⚖️ kg | FASSCO-Id. Qualität/Quality/Calid. | €/Stück Pce./Pce./Pza. |
|--|---|--|----------|---------------------------------------|---------------------------|
| Trennschnitt Fase 24° Split Cut Bevel 24° | Obermesser 361,95 x 95,25/76,2 x 6,35 14.1/4"x3.3/4"/3"x.250" | 5 Langlöcher 4 #10-24 2 1/2"-13 | 1,15 | 035.62/006F236 | * |
| | Obermesser C-635-0-1046 361,95 x 95,25/76,2 x 9,52 14.1/4"x3.3/4"/3"x.375" | 5 Langlöcher 4 1/4"-20 2 1/2"-13 | 1,65 | 035.62/009F236 | * |
| | Obermesser 361,95 x 95,25/76,2 x 12,7 14.1/4"x3.3/4"/3"x.500" | 5 Langlöcher 4 1/4"-20 2 1/2"-13 | 2,10 | 035.62/012F236 | * |
| | Untermesser B-600-0-1067 381 x 25 x 12,7 15" x 63/64" x .500" | 5 Langlöcher | 0,80 | 035.90/123F236 | * |



MACEY HARRIS / SHERIDAN

| Maschinen-Typ Type/Type/Tipo | Abmessungen in mm Size/Dimension/Tamaño | Löcher/Holes Trous/Huecos |  kg | FASSCO-Id. Qualität/Quality/Calid. | €/Stück Pce./Pce./Pza. |
|--|--|--|---|---------------------------------------|---------------------------|
| Stanzschnitt V-Fase Punch Cut V-Shape | Obermesser 361,95 x 95,25/76,2 x 4 14.1/4"x3.3/4"/3"x 5/32" | 5 Langlöcher 2 1/2"-13 | 0,80 | 035.60/004F236 | * |
| | Obermesser 361,95 x 95,25/76,2 x 5 14.1/4"x3.3/4"/3"x 3/16" | 5 Langlöcher 2 1/2"-13 | 0,98 | 035.60/005F236 | * |
| | Obermesser C-635-0-1047 361,95 x 95,25/76,2 x 6,35 14.1/4"x3.3/4"/3"x .250" | 5 Langlöcher 4 #10-24 2 1/2"-13 | 1,25 | 035.60/006F236 | * |
| | Obermesser 361,95 x 95,25/76,2 x 8 14.1/4"x3.3/4"/3"x 5/16" | 5 Langlöcher 4 1/4"-20 2 1/2"-13 | 1,55 | 035.60/008F236 | * |
| | Obermesser C-635-0-1049 361,95 x 95,25/76,2 x 9,52 14.1/4"x3.3/4"/3"x .375" | 5 Langlöcher 4 1/4"-20 2 1/2"-13 | 1,81 | 035.60/009F236 | * |
| | Obermesser 361,95 x 95,25/76,2 x 10 14.1/4"x3.3/4"/3"x 25/64" | 5 Langlöcher 4 1/4"-20 2 1/2"-13 | 1,91 | 035.60/010F236 | * |
| | Obermesser C-635-0-1051 361,95 x 95,25/76,2 x 12,7 14.1/4"x3.3/4"/3"x.500" | 5 Langlöcher 4 1/4"-20 2 1/2"-13 | 2,35 | 035.60/012F236 | * |
| | Untermesser, links B-600-0-1067 381 x 25 x 12,7 15" x 63/64" x .500" | 5 Langlöcher | 0,80 | 035.90/123F236 | * |
| | Untermesser, rechts B-600-0-1067 381 x 25 x 12,7 15" x 63/64" x .500" | 5 Langlöcher | 0,80 | 035.90/123F236 | * |

M

MANDELLI



(LMM, MBM/Michael Business Machines, Michael Miracle, Michael Ultramatic, Multitex)

| Maschinen-Typ Type/Type/Tipo | Abmessungen in mm Size/Dimension/Tamaño | Löcher/Holes Trous/Huecos |  kg | FASSCO-Id. Qualität/Quality/Calid. | €/Stück Pce./Pce./Pza. |
|--|--|------------------------------|---|---------------------------------------|---------------------------|
| LMM 58 23" | 730 x 73 x 7,3 | 5 5/16"W | 2,65 | 019.01F220 | 161,00 |
| | | | | 019.01F3000 | 253,00 |
| LMM 62 24" | 760 x 80 x 8 | 5 5/16"W | 3,30 | 019.07F220 | 161,00 |
| | | | | 019.07F3000 | 253,00 |
| LMM 62, 24" LMM 63 ab Serie 2/69 | 780 x 80 x 8 | 5 5/16"W | 3,40 | 019.02F220 | 161,00 |
| | | | | 019.02F3000 | 253,00 |
| LMM 72, 28" LMM 76, 30" | 915 x 90 x 9 | 6 3/8"W | 5,05 | 019.03F220 | 196,00 |
| | | | | 019.03F3000 | 291,00 |
| LMM 82 32" | 1015 x 90 x 9 | 7 3/8"W | 5,60 | 019.04F220 | 222,00 |
| | | | | 019.04F3000 | 321,00 |
| LMM 92 36" | 1115 x 105 x 10 | 8/M10 | 7,95 | 019.08F220 | 300,00 |
| | | | | 019.08F3000 | 439,00 |
| LMM 105, 42" LMM 107 | 1280 x 120 x 11 | 9/M12 | 11,70 | 019.05F220 | 419,00 |
| | | | | 019.05F3000 | 618,00 |
| LMM 115 46" | 1360 x 120 x 11 | 9/M12 | 12,35 | 019.09F220 | 442,00 |
| | | | | 019.09F3000 | 652,00 |
| LMM 132, 52" LMM 137, 54" | 1560 x 120 x 11 | 11/M12 | 14,20 | 019.10F220 | 511,00 |
| | | | | 019.10F3000 | 748,00 |
| LMM 150, 59" LMM 155, 61" | 1740 x 120 x 11 | 12/M12 | 15,90 | 019.06F220 | 569,00 |
| | | | | 019.06F3000 | 822,00 |

MARTIN YALE

(Franklin Spaulding)



| Maschinen-Typ Type/Type/Tipo | Abmessungen in mm Size/Dimension/Tamaño | Löcher/Holes Trous/Huecos |  kg | FASSCO-Id. Qualität/Quality/Calid. | €/Stück Pce./Pce./Pza. |
|---------------------------------|---|------------------------------|---|---------------------------------------|---------------------------|
| O-12 Portable Cutter | 381 x 63,5 x 9,4 15" x 2.1/2" x .370" (M-376-B) | 2 Ø-Löcher | 1,35 | 067.01F-220 | * |
| EZ-CUT H-175 EZ-CUT L-175 | 516 x 76,2 x 9,5 20.31" x 3" x .375" (M-1180-B) | 5 5/16"-24 | 2,55 | 067.02F220 | * |
| | | | | 067.02F3000 | * |



MC CAIN

| Maschinen-Typ Type/Type/Tipo | Abmessungen in mm Size/Dimension/Tamaño | Löcher/Holes Trous/Huecos |  kg | FASSCO-Id. Qualität/Quality/Calid. | €/Stück Pce./Pce./Pza. |
|--|---|-------------------------------------|---|---------------------------------------|---------------------------|
| A Standard | Vordermesser, oben MT-I-1525C 540 x 127 x 12,7 21.1/4"x5"x.500" | 6 Langlö. 7 3/8"-24 1 1/2"-13 | 5,55 | 016.90/001F220 | 283,00 |
| | | | | 016.90/001F3000 | 373,00 |
| | Seitenmesser, oben links MT-1088C 330 x 127 x 12,7 13"x5"x.500" | 4 Langlö. 6 3/8"-24 1 1/2"-13 | 3,50 | 016.90/023F220 | 187,00 |
| | | | | 016.90/023F3000 | 242,00 |
| | Seitenmesser, oben rechts MT-1088C 330 x 127 x 12,7 13"x5"x.500" | 4 Langlö. 6 3/8"-24 1 1/2"-13 | 3,50 | 016.90/023F220 | 187,00 |
| | | | | 016.90/023F3000 | 242,00 |
| | Vordermesser, unten MT-I-521C 541 x 38,1 x 13,5 21.312"x1.500"x .531 " | 5 zyl. vers. Langlö. | 1,85 | 016.90/101F236 | 192,00 |
| Seitenmesser, unten links MT-095B 340 x 38,1 x 13,5 13.3/8"x1.500"x .531 " | 4 zyl.vers. Langlö. | 1,05 | 016.90/123F236 | 139,00 | |
| Seitenmesser, unten rechts MT-095B 340 x 38,1 x 13,5 13.3/8"x1.500"x .531 " | 4 zyl. vers. Langlö. | 1,05 | 016.90/123F236 | 139,00 | |
| €/Satz/Set/Jeu/Juego | | | | | |
| A Standard | Satz Obermesser Set Upper knives | = 3 Messer = 3 knives | 12,55 | 016.90/300F220 | 657,00 |
| | Satz Obermesser Set Upper knives | = 3 Messer = 3 knives | 12,55 | 016.90/300F3000 | 857,00 |
| | Satz Untermesser Set Bottom knives | = 3 Messer = 3 knives | 3,95 | 016.90/303F236 | 470,00 |

M

MC CAIN



| Maschinen-Typ Type/Type/Tipo | Abmessungen in mm Size/Dimension/Tamaño | Löcher/Holes Trous/Huecos | △ kg | FASSCO-Id. Qualität/Quality/Calid. | €/Stück Pce./Pce./Pza. |
|---------------------------------|---|-------------------------------------|---------|---------------------------------------|---------------------------|
| BA MTA 20" Trimmer | Vordermesser, oben MT-I-1525C 540 x 127 x 12,7 21.1/4"x5"x .500" | 6 Langlö. 7 3/8"-24 1 1/2"-13 | 5,55 | 016.90/001F220 | 283,00 |
| | | | | 016.90/001F3000 | 373,00 |
| | Seitenmesser, oben links MT-1088C 330 x 127 x 12,7 13"x5"x .500" | 4 Langlö. 6 3/8"-24 1 1/2"-13 | 3,50 | 016.90/023F220 | 187,00 |
| | | | | 016.90/023F3000 | 242,00 |
| | Seitenmesser, oben rechts MT-1088C 330 x 127 x 12,7 13"x5"x .500" | 4 Langlö. 6 3/8"-24 1 1/2"-13 | 3,50 | 016.90/023F220 | 187,00 |
| | | | | 016.90/023F3000 | 242,00 |
| | Vordermesser, unten MT-I-521C 541 x 38,1 x 13,5 21.312"x1.500"x .531 " | 5 zyl. vers. Langlö. | 1,85 | 016.90/101F236 | 192,00 |
| | Seitenmesser, unten links MT-I-676B 340 x 38,1 x 8,75 13.3/8"x1.500"x .344" | 6 zyl. vers. Langlö. | 0,70 | 016.91/123F236 | 139,00 |
| | Seitenmesser, unten rechts MT-I-676B 340 x 38,1 x 8,75 13.3/8"x1.500"x .344" | 6 zyl. vers. Langlö. | 0,70 | 016.91/123F236 | 139,00 |
| €/Satz/Set/Jeu/Juego | | | | | |
| BA MTA 20" Trimmer | Satz Obermesser Set Upper knives | = 3 Messer = 3 knives | 12,55 | 016.91/300F220 | 657,00 |
| | Satz Obermesser Set Upper knives | = 3 Messer = 3 knives | 12,55 | 016.91/300F3000 | 857,00 |
| | Satz Untermesser Set Bottom knives | = 3 Messer = 3 knives | 3,25 | 016.91/303F236 | 470,00 |



| Maschinen-Typ Type/Type/Tipo | Abmessungen in mm Size/Dimension/Tamaño | Löcher/Holes Trous/Huecos |  kg | FASSCO-Id. Qualität/Quality/Calid. | €/Stück Pce./Pce./Pza. |
|--|---|-------------------------------------|---|---------------------------------------|---------------------------|
| Standard A 13.1/2" Buchkopf- Beschnitt 13.1/2" Book-Head Length | Vordermesser, oben MT-I-1525C 540 x 127 x 12,7 21.1/4"x5"x.500" | 6 Langlö. 7 3/8"-24 1 1/2"-13 | 5,55 | 016.90/001F220 | 283,00 |
| | | | | 016.90/001F3000 | 373,00 |
| | Seitenmesser, oben links MT-088C4 355,6 x 127 x 12,7 14"x5"x.500" | 4 Langlö. 6 3/8"-24 1 1/2"-13 | 3,60 | 016.92/023F220 | 199,00 |
| | | | | 016.92/023F3000 | 267,00 |
| | Seitenmesser, oben rechts MT-088C4 355,6 x 127 x 12,7 14"x5"x.500" | 4 Langlö. 6 3/8"-24 1 1/2"-13 | 3,60 | 016.92/023F220 | 199,00 |
| | | | | 016.92/023F3000 | 267,00 |
| | Vordermesser, unten MT-I-521C 541 x 38,1 x 13,5 21.312"x1.500"x .531 " | 5 zyl.vers. Langlö. | 1,85 | 016.90/101F236 | 192,00 |
| | Seitenmesser, unten links MT-095B2 355,6 x 38,1 x 13,5 14"x1.500"x .531 " | 4 zyl.vers. Langlö. | 1,10 | 016.92/123F236 | 143,00 |
| | Seitenmesser, unten rechts MT-095B2 355,6 x 38,1 x 13,5 14"x1.500"x .531 " | 4 zyl.vers. Langlö. | 1,10 | 016.92/123F236 | 143,00 |
| €/Satz/Set/Jeu/Juego | | | | | |
| Standard A 13.1/2" Buchkopf- Beschnitt | Satz Obermesser Set Upper knives | = 3 Messer = 3 knives | 12,75 | 016.92/300F220 | 681,00 |
| | Satz Obermesser Set Upper knives | = 3 Messer = 3 knives | 12,75 | 016.92/300F3000 | 907,00 |
| | Satz Untermesser Set Bottom knives | = 3 Messer = 3 knives | 4,05 | 016.92/303F236 | 478,00 |

MC CAIN



| Maschinen-Typ Type/Type/Tipo | Abmessungen in mm Size/Dimension/Tamaño | Löcher/Holes Trous/Huecos | △ ⁺ △ kg | FASSCO-Id. Qualität/Quality/Calid. | €/Stück Pce./Pce./Pza. |
|---------------------------------|--|--------------------------------------|------------------------|---------------------------------------|---------------------------|
| OT-Trimmer High Speed | Vordermesser, oben TA-217C 373,1 x 127 x 12,7 14.11/16" x 5" x .500" | 4 Langlö. 5 3/8" -24 1 1/2"-13 | 3,85 | 016.93/001F220 | 219,00 |
| | | | | 016.93/001F3000 | 288,00 |
| | Seitenmesser, oben links TA-580LC 330,2 x 127 x 12,7 13" x 5" x .500" | 4 Langlö. 6 3/8" -24 1 1/2"-13 | 3,50 | 016.93/002F220 | 212,00 |
| | | | | 016.93/002F3000 | 281,00 |
| | Seitenmesser, oben rechts TA-581RC 330,2 x 127 x 12,7 13" x 5" x .500" | 4 Langlö. 6 3/8" -24 1 1/2"-13 | 3,50 | 016.93/003F220 | 212,00 |
| | | | | 016.93/003F3000 | 281,00 |
| | Vordermesser, unten MT-I-521C 541 x 38,1 x 13,5 21.312" x 1.500" x .531" | 5 zyl. vers. Langlö. | 1,85 | 016.90/101F236 | 192,00 |
| | Seitenmesser, unten links MT-095B 340 x 38,1 x 13,5 13.3/8" x 1.500" x .531" | 4 zyl. vers. Langlö. | 1,05 | 016.90/123F236 | 139,00 |
| | Seitenmesser, unten rechts MT-095B 340 x 38,1 x 13,5 13.3/8" x 1.500" x .531" | 4 zyl. vers. Langlö. | 1,05 | 016.90/123F236 | 139,00 |
| €/Satz/Set/Jeu/Juego | | | | | |
| OT-Trimmer High Speed | Satz Obermesser Set Upper knives | = 3 Messer = 3 knives | 10,85 | 016.93/300F220 | 643,00 |
| | Satz Obermesser Set Upper knives | = 3 Messer = 3 knives | 10,85 | 016.93/300F3000 | 850,00 |
| | Satz Untermesser Set Bottom knives | = 3 Messer = 3 knives | 3,95 | 016.93/303F236 | 470,00 |

| Maschinen-Typ Type/Type/Tipo | Abmessungen in mm Size/Dimension/Tamaño | Löcher/Holes Trous/Huecos | △ ⁺ △ kg | FASSCO-Id. Qualität/Quality/Calid. | €/Stück Pce./Pce./Pza. |
|---------------------------------|---|--|------------------------|---------------------------------------|---------------------------|
| OT 3000 24" | Vordermesser, oben MT4-1305C 660,4 x 127 x 12,7 26" x 5" x .500" | 8 Langlö. 3 1/2"-13 9 3/8"-24 4 1/4"-20 | 6,80 | 016.94/001F220 | 344,00 |
| | | | | 016.94/001F3000 | 454,00 |
| | Vordermesser, unten MT4-1306C 660,4 x 38,1 x 13,5 26" x 1.500" x .531" | 7 zyl. vers. Langlö. | 2,25 | 016.94/101F236 | 215,00 |

**MC CAIN**

| Maschinen-Typ Type/Type/Tipo | Abmessungen in mm Size/Dimension/Tamaño | Löcher/Holes Trous/Huecos | kg | FASSCO-Id. Qualität/Quality/Calid. | €/Stück Pce./Pce./Pza. |
|--|--|------------------------------|------|---------------------------------------|---------------------------|
| Stanzschnitt V-Fase Punch cut V-Shape | Obermesser CK-1864C1-3/16" 330,2 x 114,3 x 4,76 13" x 4.1/2" x .187" | 4 Langlö. | 1,26 | 016.60/005F236 | 471,00 |
| | Obermesser CK-1864C3-1/4" 330,2 x 114,3 x 6,35 13" x 4.1/2" x .250" | 4 Langlö. | 1,70 | 016.60/006F236 | 426,00 |
| | Obermesser CK-1864C-5/16" 330,2 x 114,3 x 7,92 13" x 4.1/2" x .312" | 4 Langlö. | 2,08 | 016.60/008F236 | 471,00 |
| | Obermesser CK-1864C4-3/8" 330,2 x 114,3 x 9,52 13" x 4.1/2" x .375" | 4 Langlö. | 2,50 | 016.60/009F236 | 471,00 |
| | Obermesser CK-1864C2-7/16" 330,2 x 114,3 x 11,11 13" x 4.1/2" x .437" | 4 Langlö. | 2,93 | 016.60/011F236 | 515,00 |
| | Obermesser CK-1864C5-1/2" 330,2 x 114,3 x 12,70 13" x 4.1/2" x .500" | 4 Langlö. | 3,35 | 016.60/012F236 | 515,00 |
| | Untermesser, links CK-865LC2 312,74 x 42,86 x 14,3 12.5/16"x1.11/16"x .562" | 4 5/16"-18 | 1,40 | 016.61/102F236 | 158,00 |
| | Untermesser, rechts CK-865RC2 338,14 x 42,86 x 14,3 13.5/16"x1.11/16"x.562" | 4 5/16"-18 | 1,46 | 016.61/103F236 | 158,00 |

**MÜLLER-LANGENFELD**

(Gidico, MKW, Laconda Vulkan)

| Maschinen-Typ Type/Type/Tipo | Abmessungen in mm Size/Dimension/Tamaño | Löcher/Holes Trous/Huecos | kg | FASSCO-Id. Qualität/Quality/Calid. | €/Stück Pce./Pce./Pza. |
|---------------------------------|---|------------------------------|------|---------------------------------------|---------------------------|
| HF 33c | Obermesser 91.06.009A 450 x 130/75/67 x 6 | 5/M6 | 1,35 | 066.90/001F236 | 200,00 |
| | Untermesser 91.06.008A 460 x 40 x 15/10 | 5 vers.Lö. | 1,40 | 066.90/101F236 | 136,00 |

| Maschinen-Typ Type/Type/Tipo | Abmessungen in mm Size/Dimension/Tamaño | Löcher/Holes Trous/Huecos | kg | FASSCO-Id. Qualität/Quality/Calid. | €/Stück Pce./Pce./Pza. |
|---|--|------------------------------|------|---------------------------------------|---------------------------|
| HF 33c für Kleinformat 50 mm | Untermesser 91.06.165 460 x 30 x 15/10 | 5 vers.Lö. | 1,05 | 066.89/101F236 | 138,00 |

MÜLLER-LANGENFELD

(Gidico, MKW, Laconda Vulkan)



| Maschinen-Typ Type/Type/Tipo | Abmessungen in mm Size/Dimension/Tamaño | Löcher/Holes Trous/Huecos | ⚖ kg | FASSCO-Id. Qualität/Quality/Calid. | €/Stück Pce./Pce./Pza. |
|---------------------------------|--|------------------------------|---------|---------------------------------------|---------------------------|
| HF 40x55,5c | Obermesser 94.06.009 500 x 130/75/67 x 6 | 6/M6 | 1,52 | 066.95/001F236 | 261,00 |
| | Untermesser 94.06.008 510 x 40 x 15/10 | 5 vers.Lö. | 1,57 | 066.95/101F236 | 178,00 |

| Maschinen-Typ Type/Type/Tipo | Abmessungen in mm Size/Dimension/Tamaño | Löcher/Holes Trous/Huecos | ⚖ kg | FASSCO-Id. Qualität/Quality/Calid. | €/Stück Pce./Pce./Pza. |
|---------------------------------|---|------------------------------|---------|---------------------------------------|---------------------------|
| HF 2c 50 HF 22 CSF | Obermesser 96.06.009A 600 x 130/75/64,2 x 6 | 6/M6 | 1,83 | 066.93/001F236 | 335,00 |
| | Untermesser 96.06.008 610 x 40 x 15/10 | 6 vers.Lö. | 2,03 | 066.93/101F236 | 225,00 |

MÜLLER-LANGENFELD

(Gidico, MKW, Laconda Vulkan)



| Maschinen-Typ Type/Type/Tipo | Abmessungen in mm Size/Dimension/Tamaño | Löcher/Holes Trous/Huecos | ⚖ kg | FASSCO-Id. Qualität/Quality/Calid. | €/Stück Pce./Pce./Pza. |
|---------------------------------|---|------------------------------|---------|---------------------------------------|---------------------------|
| HF 70x50 | Obermesser HF70.06.009A 800 x 130/75/67 x 6 | 9/M6 | 2,41 | 066.94/001F236 | * |
| | Untermesser HF70.06.008A 810 x 40 x 15/10 | 7 vers.Lö. | 2,54 | 066.94/101F236 | * |

| Maschinen-Typ Type/Type/Tipo | Abmessungen in mm Size/Dimension/Tamaño | Löcher/Holes Trous/Huecos | ⚖ kg | FASSCO-Id. Qualität/Quality/Calid. | €/Stück Pce./Pce./Pza. |
|---------------------------------|---|------------------------------|---------|---------------------------------------|---------------------------|
| C 2 Seitenbeschnitt L=300 | Obermesser, links 99.06.052 300 x 65/56 x 6 | 14/M6 | 0,73 | 066.91/002F236 | 112,00 |
| | Obermesser, rechts 99.06.051 300 x 65/56 x 6 | 14/M6 | 0,73 | 066.91/003F236 | 112,00 |
| | Untermesser, links 99.06.010A 300 x 25 x 15/10 | 4/9,5 Ø | 0,61 | 066.91/145F236 | 117,00 |
| | Untermesser, rechts 99.06.010A 300 x 25 x 15/10 | 4/9,5 Ø | 0,61 | 066.91/145F236 | 117,00 |

| Maschinen-Typ Type/Type/Tipo | Abmessungen in mm Size/Dimension/Tamaño | Löcher/Holes Trous/Huecos | ⚖ kg | FASSCO-Id. Qualität/Quality/Calid. | €/Stück Pce./Pce./Pza. |
|---------------------------------|--|------------------------------|---------|---------------------------------------|---------------------------|
| C2 Kleinformat 20 mm | Untermesser, links 300 x 20 x 15/10 | 4/8,5 Ø | 0,50 | 066.93/123F236 | * |
| | Untermesser, rechts 300 x 20 x 15/10 | 4/8,5 Ø | 0,50 | 066.93/123F236 | * |

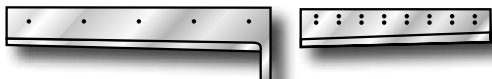

MÜLLER-LANGENFELD

(Gidico, MKW, Laconda Vulkan)

| Maschinen-Typ Type/Type/Tipo | Abmessungen in mm Size/Dimension/Tamaño | Löcher/Holes Trous/Huecos | △ kg | FASSCO-Id. Qualität/Quality/Calid. | €/Stück Pce./Pce./Pza. |
|-------------------------------------|--|------------------------------|---------|---------------------------------------|---------------------------|
| C 2 Seitenbeschnitt alt / old | Untermesser, links 99.06 300 x 25 x 15/10 | 4 vers. Lö. | 0,61 | 066.91/123F236 | * |
| | Untermesser, rechts 99.06 300 x 25 x 15/10 | 4 vers. Lö. | 0,61 | 066.91/123F236 | * |

| Maschinen-Typ Type/Type/Tipo | Abmessungen in mm Size/Dimension/Tamaño | Löcher/Holes Trous/Huecos | △ kg | FASSCO-Id. Qualität/Quality/Calid. | €/Stück Pce./Pce./Pza. |
|---|--|------------------------------|---------|---------------------------------------|---------------------------|
| C 2 / 40x55,5 Seitenbeschnitt L=330 | Obermesser, links 99.06.011L 330 x 65/56 x 6 | 14/M6 | 0,80 | 066.92/002F236 | * |
| | Obermesser, rechts 99.06.011R 330 x 65/56 x 6 | 14/M6 | 0,80 | 066.92/003F236 | * |
| | Untermesser, links 99.06.010 330 x 25 x 15/10 | 4/9,5 Ø | 0,65 | 066.92/123F236 | * |
| | Untermesser, rechts 99.06.010 330 x 25 x 15/10 | 4/9,5 Ø | 0,65 | 066.92/123F236 | * |

| Maschinen-Typ Type/Type/Tipo | Abmessungen in mm Size/Dimension/Tamaño | Löcher/Holes Trous/Huecos | △ kg | FASSCO-Id. Qualität/Quality/Calid. | €/Stück Pce./Pce./Pza. |
|--|--|------------------------------|---------|---------------------------------------|---------------------------|
| C 2 Seitenbeschnitt mit Nase with leg | Obermesser, links 99.06.052A 300 x 95/80/60 x 6 | 14/M6 | 0,92 | 066.91/012F236 | * |
| | Obermesser, rechts 99.06.051A 300 x 95/80/60 x 6 | 14/M6 | 0,92 | 066.91/013F236 | * |
| | Untermesser, links 99.06.010A 300 x 25 x 15/10 | 4/9,5 Ø | 0,61 | 066.91/145F236 | * |
| | Untermesser, rechts 99.06.010A 300 x 25 x 15/10 | 4/9,5 Ø | 0,61 | 066.91/145F236 | * |



MÜLLER-LANGENFELD

(Gidico, MKW, Laconda Vulkan)

| Maschinen-Typ Type/Type/Tipo | Abmessungen in mm Size/Dimension/Tamaño | Löcher/Holes Trous/Huecos | △ kg | FASSCO-Id. Qualität/Quality/Calid. | €/Stück Pce./Pce./Pza. |
|--------------------------------------|--|------------------------------|---------|---------------------------------------|---------------------------|
| C 70x50 Trennschnitt Split cut | Obermesser (Fase 30°) C70.06.012A 300 x 95/80/60 x 6 | 4 Langlöcher 2/M4 | 0,92 | 066.64F236 | * |
| | Untermesser 99.06.010A 300 x 25 x 15/10 | 4/9,5 Ø | 0,61 | 066.91/145F236 | * |

MÜLLER-LANGENFELD

(Gidico, MKW, Laconda Vulkan)



| Maschinen-Typ Type/Type/Tipo | Abmessungen in mm Size/Dimension/Tamaño | Löcher/Holes Trous/Huecos | ⚖️ kg | FASSCO-Id. Qualität/Quality/Calid. | €/Stück Pce./Pce./Pza. |
|--|---|------------------------------|----------|---------------------------------------|---------------------------|
| CS 1 Stanzschnitt V-Fase mit Nase Chop cut V-Shape with leg L=300 | Obermesser 99.16.012B 300 x 95/83/60 x 6 | 4 Langlöcher 2/M4 | 0,90 | 066.62/006F236 | * |
| | Obermesser 99.16.013B 300 x 95/83/60 x 8 | 4 Langlöcher 2/M4 | 1,20 | 066.62/008F236 | * |
| | Obermesser 99.16.014B 300 x 95/83/60 x 10 | 4 Langlöcher 2/M4 | 1,50 | 066.62/010F236 | * |
| | Untermesser, links 99.06.010A 300 x 25 x 15/10 | 4/9,5 Ø | 0,61 | 066.91/145F236 | * |
| | Untermesser, rechts 99.06.010A 300 x 25 x 15/10 | 4/9,5 Ø | 0,61 | 066.91/145F236 | * |

| Maschinen-Typ Type/Type/Tipo | Abmessungen in mm Size/Dimension/Tamaño | Löcher/Holes Trous/Huecos | ⚖️ kg | FASSCO-Id. Qualität/Quality/Calid. | €/Stück Pce./Pce./Pza. |
|--|---|--|----------|---------------------------------------|---------------------------|
| CS 1 Stanzschnitt V-Fase mit Luft Chop cut V-Shape with air L=300 | Obermesser (99.16.012B) 300 x 95/83/60 x 6 | 4 Langlöcher 2/M4 5 Luftlö. 3,2 Ø | 0,90 | 066.62/206F236 | * |
| | Obermesser (99.16.013B) 300 x 95/83/60 x 8 | 4 Langlöcher 2/M4 5 Luftlö. 3,2 Ø | 1,20 | 066.62/208F236 | * |
| | Obermesser (99.16.014B) 300 x 95/83/60 x 10 | 4 Langlöcher 2/M4 5 Luftlö. 3,2 Ø | 1,50 | 066.62/210F236 | * |
| | Untermesser, links 99.06.010A 300 x 25 x 15/10 | 4/9,5 Ø | 0,61 | 066.91/145F236 | * |
| | Untermesser, rechts 99.06.010A 300 x 25 x 15/10 | 4/9,5 Ø | 0,61 | 066.91/145F236 | * |

| Maschinen-Typ Type/Type/Tipo | Abmessungen in mm Size/Dimension/Tamaño | Löcher/Holes Trous/Huecos | ⚖️ kg | FASSCO-Id. Qualität/Quality/Calid. | €/Stück Pce./Pce./Pza. |
|---|--|------------------------------|----------|---------------------------------------|---------------------------|
| CS 1 Stanzschnitt V-Fase mit Nase Chop cut with leg L=330 | Obermesser 99.36.012 330 x 95/85/60 x 6 | 5 Langlöcher 2/M4 | 0,95 | 066.60/006F236 | * |
| | Untermesser, links 99.06.010 330 x 25 x 15/10 | 4/9,5 Ø | 0,65 | 066.92/123F236 | * |
| | Untermesser, rechts 99.06.010 330 x 25 x 15/10 | 4/9,5 Ø | 0,65 | 066.92/123F236 | * |

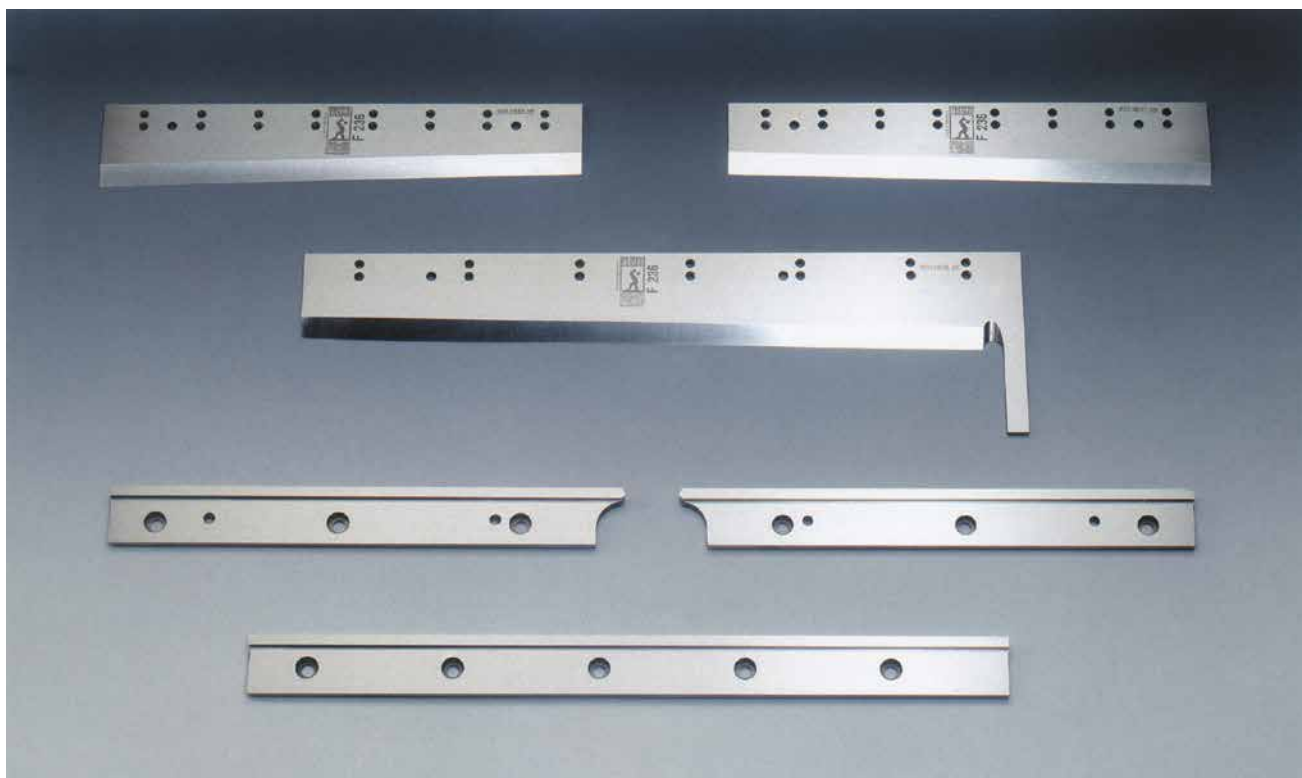

MÜLLER-MARTINI (GRAPHA)

| Maschinen-Typ Type/Type/Tipo | Abmessungen in mm Size/Dimension/Tamaño | Löcher/Holes Trous/Huecos | kg | FASSCO-Id. Qualität/Quality/Calid. | €/Stück Pce./Pce./Pza. |
|--|---|------------------------------|----------------|---------------------------------------|---------------------------|
| DSS 890 (514-515) Anleger: IGV, 217, 221 235, 235/5, 321 335, (1509) | Vordermesser, oben 890.0535.2F (F5) 890.0546.2 (F8) 520 x 140/75/65 x 6 | 14/M6 2/7 Ø | 1,55 | 014.99/001F236 | 221,00 |
| | | | | 014.99/001F3000 | 270,00 |
| | Seitenmesser, oben links 890.0536.3B (F5) 890.0544.3 (F8) 355 x 65/55 x 6 | 16/M6 2/7 Ø | 0,84 | 014.99/002F236 | 102,00 |
| | | | | 014.99/002F3000 | 145,00 |
| | Seitenmesser, oben rechts 890.0537.3B (F5) 890.0543.3 (F8) 355 x 65/55 x 6 | 16/M6 2/7 Ø | 0,84 | 014.99/003F236 | 102,00 |
| | | | | 014.99/003F3000 | 145,00 |
| | Vordermesser, unten 890.0538.3D (F5) 520 x 40 x 15/10 | 5 zyl.vers. | 1,70 | 014.99/101F236 | 140,00 |
| Seitenmesser, unten links 890.0539.3B (F5) 360 x 40 x 15/10 | 3 zyl.vers. 2/7 Ø | 1,14 | 014.99/102F236 | 112,00 | |
| Seitenmesser, unten rechts 890.0540.3B (F5) 360 x 40 x 15/10 | 3 zyl.vers. 2/7 Ø | 1,14 | 014.99/103F236 | 112,00 | |
| €/Satz/Set/Jeu/Juego | | | | | |
| DSS 890 | Satz Obermesser Set Upper knives | = 3 Messer = 3 knives | 3,23 | 014.99/300F236 | 425,00 |
| | Satz Obermesser Set Upper knives | = 3 Messer = 3 knives | 3,23 | 014.99/300F3000 | 560,00 |
| | Satz Untermesser Set Bottom knives | = 3 Messer = 3 knives | 3,98 | 014.99/303F236 | 364,00 |

MÜLLER-MARTINI (GRAPHA)



| Maschinen-Typ Type/Type/Tipo | Abmessungen in mm Size/Dimension/Tamaño | Löcher/Holes Trous/Huecos | ⚖️ kg | FASSCO-Id. Qualität/Quality/Calid. | €/Stück Pce./Pce./Pza. |
|---|---|------------------------------|----------|---------------------------------------|---------------------------|
| DSS 890 (514-515) altes Modell old Model | Vordermesser, oben 890.0535.2B 495 x 140/75/65 x 6 | 12/M6 2/7 Ø | 1,50 | 014.99/011F236 | 266,00 |
| | Seitenmesser, oben links 890.0536.3B 355 x 65/55 x 6 | 16/M6 2/7 Ø | 0,84 | 014.99/002F236 | 102,00 |
| | Seitenmesser, oben rechts 890.0537.3B 355 x 65/55 x 6 | 16/M6 2/7 Ø | 0,84 | 014.99/003F236 | 102,00 |
| | Vordermesser, unten 890.0538.3C 505 x 40 x 15/10 | 5 zyl. vers. | 1,656 | 014.99/111F236 | 168,00 |
| | Seitenmesser, unten links 890.0539.3B 360 x 40 x 15/10 | 3 zyl.vers. 2/7 Ø | 1,14 | 014.99/102F236 | 112,00 |
| | Seitenmesser, unten rechts 890.0540.3B 360 x 40 x 15/10 | 3 zyl.vers. 2/7 Ø | 1,14 | 014.99/103F236 | 112,00 |
| €/Satz/Set/Jeu/Juego | | | | | |
| DSS 890 (514-515) altes Modell old Model | Satz Obermesser Set Upper knives | = 3 Messer = 3 knives | 3,18 | 014.99A/300F236 | 470,00 |
| | Satz Untermesser Set Bottom knives | = 3 Messer = 3 knives | 3,94 | 014.99A/303F236 | 392,00 |

| Maschinen-Typ Type/Type/Tipo | Abmessungen in mm Size/Dimension/Tamaño | Löcher/Holes Trous/Huecos | ⚖️ kg | FASSCO-Id. Qualität/Quality/Calid. | €/Stück Pce./Pce./Pza. |
|---------------------------------|--|------------------------------|----------|---------------------------------------|---------------------------|
| DS I 708/ 877 | Vordermesser, oben 877.0708.2E 490 x 140/75/65 x 6 | 6/M6 | 1,48 | 014.90/001F236 | 266,00 |
| | Seitenmesser, oben links 877.0728.3 335 x 65/55 x 6 | 4/M6 | 0,82 | 014.90/002F236 | 125,00 |
| | Seitenmesser, oben rechts 877.0729.3 335 x 65/55 x 6 | 4/M6 | 0,82 | 014.90/003F236 | 125,00 |
| | Vordermesser, unten 877.0725.3A 500 x 40 x 15/10 | 5 zyl. vers. | 1,65 | 014.90/101F236 | 168,00 |
| | Seitenmesser, unten links 877.0730.3 340 x 40 x 15/10 | 3 zyl. vers. | 1,10 | 014.90/102F236 | 135,00 |
| | Seitenmesser, unten rechts 877.0731.3 340 x 40 x 15/10 | 3 zyl vers. | 1,10 | 014.90/103F236 | 135,00 |
| €/Satz/Set/Jeu/Juego | | | | | |
| DS I 708/ 877 | Satz Obermesser Set Upper knives | = 3 Messer = 3 knives | 3,12 | 014.90/300F236 | 516,00 |
| | Satz Untermesser Set Bottom knives | = 3 Messer = 3 knives | 3,85 | 014.90/303F236 | 438,00 |



MÜLLER-MARTINI (GRAPHA)

| Maschinen-Typ Type/Type/Tipo | Abmessungen in mm Size/Dimension/Tamaño | Löcher/Holes Trous/Huecos | ⚖️ kg | FASSCO-Id. Qualität/Quality/Calid. | €/Stück Pce./Pce./Pza. |
|--|---|------------------------------|----------|---------------------------------------|---------------------------|
| DSS 890 Schwingschnitt Swing cut 6 mm | Vordermesser, oben 890.0535.2F 520 x 140/75/65 x 6 | 14/M6 2/7 Ø | 1,55 | 014.99/001F236 | 221,00 |
| | Seitenmesser, oben links 890.3311.3A 355/337 x 65/55 x 6 | 16/M6 2/7 Ø | 0,81 | 014.98/002F236 | 125,00 |
| | Seitenmesser, oben rechts 890.3312.3A 355/337 x 65/55 x 6 | 16/M6 2/7 Ø | 0,81 | 014.98/003F236 | 125,00 |
| | Vordermesser, unten 890.0538.3D 520 x 40 x 15/10 | 5 zyl.vers. | 1,70 | 014.99/101F236 | 140,00 |
| | Seitenmesser, unten links 890.0539.3B 360 x 40 x 15/10 | 3 zyl. vers. 2/7 Ø | 1,14 | 014.99/102F236 | 112,00 |
| | Seitenmesser, unten rechts 890.0540.3B 360 x 40 x 15/10 | 3 zyl. vers. 2/7 Ø | 1,14 | 014.99/103F236 | 112,00 |
| €/Satz/Set/Jeu/Juego | | | | | |
| DSS 890 Schwingschnitt Swing cut 6 mm | Satz Obermesser Set Upper knives | = 3 Messer = 3 knives | 3,17 | 014.98/300F236 | 471,00 |
| | Satz Untermesser Set Bottom knives | = 3 Messer = 3 knives | 3,98 | 014.99/303F236 | 364,00 |

| Maschinen-Typ Type/Type/Tipo | Abmessungen in mm Size/Dimension/Tamaño | Löcher/Holes Trous/Huecos | ⚖️ kg | FASSCO-Id. Qualität/Quality/Calid. | €/Stück Pce./Pce./Pza. |
|--|--|------------------------------|----------|---------------------------------------|---------------------------|
| DSS 890 Spezial-Format 135 MS 100 | Vordermesser, oben 890.0535.2F 520 x 140/75/65 x 6 | 14/M6 2/7 Ø | 1,55 | 014.99/001F236 | 221,00 |
| | Seitenmesser, oben links 890.0536.3B 355 x 65/55 x 6 | 16/M6 2/7 Ø | 0,84 | 014.99/002F236 | 102,00 |
| | Seitenmesser, oben rechts 890.0537.3B 355 x 65/55 x 6 | 16/M6 2/7 Ø | 0,84 | 014.99/003F236 | 102,00 |
| | Vordermesser, unten 890.0538.3D 520 x 40 x 15/10 | 5 zyl.vers. | 1,70 | 014.99/101F236 | 140,00 |
| | Seitenmesser, unten links 890.0541.3D 360 x 40 x 10/7 | 3 zyl.vers. 2/7 Ø | 0,76 | 014.97/102F236 | 135,00 |
| | Seitenmesser, unten rechts 890.0542.3C 360 x 40 x 10/7 | 3 zyl.vers. 2/7 Ø | 0,76 | 014.97/103F236 | 135,00 |
| €/Satz/Set/Jeu/Juego | | | | | |
| DSS 890 Spezial-Format 135 MS 100 | Satz Obermesser Set Upper knives | = 3 Messer = 3 knives | 3,23 | 014.99/300F236 | 425,00 |
| | Satz Untermesser Set Bottom knives | = 3 Messer = 3 knives | 3,22 | 014.97/303F236 | 410,00 |

MÜLLER-MARTINI (GRAPHA)



| Maschinen-Typ Type/Type/Tipo | Abmessungen in mm Size/Dimension/Tamaño | Löcher/Holes Trous/Huecos | △ kg | FASSCO-Id. Qualität/Quality/Calid. | €/Stück Pce./Pce./Pza. |
|---|--|------------------------------|---------|---------------------------------------|---------------------------|
| DSS 10 mm Schwingschnitt Swing cut | Vordermesser, oben 890.0545.2 (F8) 495 x 140/75/65 x 10 | 12/M6 2/7 Ø | 2,30 | 014.96/001F236 | 275,00 |
| | Seitenmesser, oben links 890.0547.3 (F8) 355 x 65/55 x 10 | 16/M6 2/7 Ø | 1,24 | 014.96/002F236 | 145,00 |
| | Seitenmesser, oben rechts 890.0548.3 (F8) 355 x 65/55 x 10 | 16/M6 2/7 Ø | 1,24 | 014.96/003F236 | 145,00 |
| | Vordermesser, unten 890.0538.3C 505 x 40 x 15/10 | 5 zyl.vers. | 1,66 | 014.99/111F236 | 168,00 |
| | Seitenmesser, unten links 890.0539.3B 360 x 40 x 15/10 | 3 zyl.vers. 2/7 Ø | 1,14 | 014.99/102F236 | 112,00 |
| | Seitenmesser, unten rechts 890.0540.3B 360 x 40 x 15/10 | 3 zyl.vers. 2/7 Ø | 1,14 | 014.99/103F236 | 112,00 |
| €/Satz/Set/Jeu/Juego | | | | | |
| DSS 10 mm Schwingschnitt Swing cut | Satz Obermesser Set Upper knives | = 3 Messer = 3 knives | 4,78 | 014.96/300F236 | 565,00 |
| | Satz Untermesser Set Bottom knives | = 3 Messer = 3 knives | 3,94 | 014.96/303F236 | 392,00 |

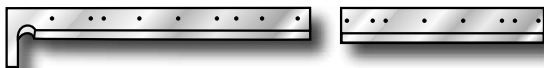

MÜLLER-MARTINI (GRAPHA)

| Maschinen-Typ Type/Type/Tipo | Abmessungen in mm Size/Dimension/Tamaño | Löcher/Holes Trous/Huecos | △ kg | FASSCO-Id. Qualität/Quality/Calid. | €/Stück Pce./Pce./Pza. |
|--|---|------------------------------------|----------------|---------------------------------------|---------------------------|
| DS 240 | Vordermesser, oben 240.1424.2B (F5) 240.1423.2 (F8) 550 x 80 x 12 | 12/M8 4 off.Langlö. 4/7 Ø | 3,10 | 014.94/001F236 | 255,00 |
| | | | | 014.94/001F3000 | 280,00 |
| | Seitenmesser, oben links 240.1440.3D (F5) 240.1439.3 (F8) 395 x 80 x 12 | 12/M8 4/7 Ø | 2,25 | 014.94/023F236 | 170,00 |
| | | | | 014.94/023F3000 | 191,00 |
| | Seitenmesser, oben rechts 240.1440.3D (F5) 240.1439.3 (F8) 395 x 80 x 12 | 12/M8 4/7 Ø | 2,25 | 014.94/023F236 | 170,00 |
| | | | | 014.94/023F3000 | 191,00 |
| | Vordermesser, unten 240.1443.3D (F5) 240.1894.3 (F8) 540 x 50 x 15 | 6 zyl.vers. Langlöcher 2/9 Ø | 2,80 | 014.94/101F236 | 240,00 |
| Seitenmesser, unten links 240.1441.3D (F5) 240.1895.3 (F8) 368 x 40 x 15 | 5/M10 2/9 Ø | 1,56 | 014.94/102F236 | 130,00 | |
| Seitenmesser, unten rechts 240.1442.3D (F5) 240.1896.3 (F8) 368 x 40 x 15 | 5/M10 2/9 Ø | 1,56 | 014.94/103F236 | 130,00 | |
| €/Satz/Set/Jeu/Juego | | | | | |
| DS 240 | Satz Obermesser Set Upper knives | = 3 Messer = 3 knives | 7,60 | 014.94/300F236 | 595,00 |
| | Satz Obermesser Set Upper knives | = 3 Messer = 3 knives | 7,60 | 014.94/300F3000 | 662,00 |
| | Satz Untermesser Set Bottom knives | = 3 Messer = 3 knives | 5,92 | 014.94/303F236 | 500,00 |

| Maschinen-Typ Type/Type/Tipo | Abmessungen in mm Size/Dimension/Tamaño | Löcher/Holes Trous/Huecos | △ kg | FASSCO-Id. Qualität/Quality/Calid. | €/Stück Pce./Pce./Pza. |
|--|---|------------------------------|---------|---------------------------------------|---------------------------|
| DS 240 Kunststoff- Untermesser Plastic bottom k. | Vordermesser, unten 240.1975.2 (240.1503.2) 540 x 50 x 15 | 6 Langlöcher | 1,00 | 014.94/101F950 | * |
| | Seitenmesser, unten links 240.1969.2 (240.1505.2) 368 x 40 x 15 | 5/M10 | 0,50 | 014.94/102F950 | * |
| | Seitenmesser, unten rechts 240.1968.2 (240.1504.2) 368 x 40 x 15 | 5/M10 | 0,50 | 014.94/103F950 | * |
| €/Satz/Set/Jeu/Juego | | | | | |
| DS 240 Kunststoff- Untermesser Plastic bottom k. | Satz Untermesser Set Bottom knives | = 3 Messer = 3 knives | 2,00 | 014.94/300F950 | * |

MÜLLER-MARTINI (GRAPHA)

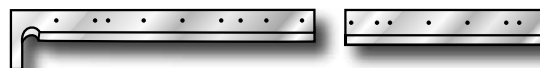

| Maschinen-Typ Type/Type/Tipo | Abmessungen in mm Size/Dimension/Tamaño | Löcher/Holes Trous/Huecos | △ kg | FASSCO-Id. Qualität/Quality/Calid. | €/Stück Pce./Pce./Pza. |
|---|--|------------------------------|---------|---------------------------------------|---------------------------|
| DS 241 bis Serie 1.0251.0400.- .07 | Vordermesser, oben 251.2006.2C (F5) 251.2201.2 (F8) 530 x 95/65 x 8 | 7/M6 2/7 Ø | 1,83 | 014.00/001F236 | 230,00 |
| | | | | 014.00/001F3000 | 290,00 |
| | Seitenmesser, oben links 251.2005.3D (F5) 251.2200.3 (F8) 365 x 60 x 8 | 6/M6 2/7 Ø | 1,10 | 014.00/023F236 | 105,00 |
| | | | | 014.00/023F3000 | 142,00 |
| | Seitenmesser, oben rechts 251.2005.3D (F5) 251.2200.3 (F8) 365 x 60 x 8 | 6/M6 2/7 Ø | 1,10 | 014.00/023F236 | 105,00 |
| | | | | 014.00/023F3000 | 142,00 |
| | Vordermesser, unten 251.2004.3C (F5) 251.2076.3 (F8) 540 x 40 x 15/10 | 5 zyl.vers. 2/9 Ø | 1,77 | 014.00/101F236 | 151,00 |
| | Seitenmesser, unten links 890.0539.3B 360 x 40 x 15/10 | 3 zyl.vers. 2/7 Ø | 1,14 | 014.99/102F236 | 112,00 |
| | Seitenmesser, unten rechts 890.0540.3B 360 x 40 x 15/10 | 3 zyl.vers. 2/7 Ø | 1,14 | 014.99/103F236 | 112,00 |
| | €/Satz/Set/Jeu/Juego | | | | |
| DS 241 bis Serie 1.0251.0400.- .07 | Satz Obermesser Set Upper knives | = 3 Messer = 3 knives | 4,03 | 014.00/300F236 | 440,00 |
| | Satz Obermesser Set Upper knives | = 3 Messer = 3 knives | 4,03 | 014.00/300F3000 | 574,00 |
| | Satz Untermesser Set Bottom knives | = 3 Messer = 3 knives | 4,05 | 014.93/303F236 | 375,00 |

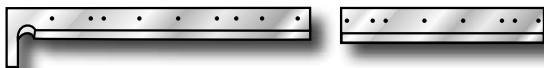

MÜLLER-MARTINI (GRAPHA)

| Maschinen-Typ Type/Type/Tipo | Abmessungen in mm Size/Dimension/Tamaño | Löcher/Holes Trous/Huecos | △ kg | FASSCO-Id. Qualität/Quality/Calid. | €/Stück Pce./Pce./Pza. |
|--|--|------------------------------|---------|---------------------------------------|---------------------------|
| DS 241 ab Serie 1.0251.0400.- .08 (8/80) | Vordermesser, oben 251.2119.2C (F5) 251.2118.2 (F8) 550 x 90/65 x 8 | 8/M6 2/7 Ø | 1,86 | 014.92/001F236 | 230,00 |
| | | | | 014.92/001F3000 | 290,00 |
| | Seitenmesser, oben links 251.2005.3D (F5) 251.2200.3 (F8) 365 x 60 x 8 | 6/M6 2/7 Ø | 1,10 | 014.00/023F236 | 105,00 |
| | | | | 014.00/023F3000 | 142,00 |
| | Seitenmesser, oben rechts 251.2005.3D (F5) 251.2200.3 (F8) 365 x 60 x 8 | 6/M6 2/7 Ø | 1,10 | 014.00/023F236 | 105,00 |
| | | | | 014.00/023F3000 | 142,00 |
| | Vordermesser, unten 251.2116.3A (F5) 251.2115.3 (F8) 555 x 40 x 15/10 | 5 zyl.vers. 2/9 Ø | 1,82 | 014.92/101F236 | 151,00 |
| | Seitenmesser, unten links 890.0539.3B 360 x 40 x 15/10 | 3 zyl.vers. 2/7 Ø | 1,14 | 014.99/102F236 | 112,00 |
| | Seitenmesser, unten rechts 890.0540.3B 360 x 40 x 15/10 | 3 zyl.vers. 2/7 Ø | 1,14 | 014.99/103F236 | 112,00 |
| €/Satz/Set/Jeu/Juego | | | | | |
| DS 241 ab Serie 1.0251.0400.- .08 (8/80) | Satz Obermesser Set Upper knives | = 3 Messer = 3 knives | 4,06 | 014.91/300F236 | 440,00 |
| | Satz Obermesser Set Upper knives | = 3 Messer = 3 knives | 4,06 | 014.91/300F3000 | 574,00 |
| | Satz Untermesser Set Bottom knives | = 3 Messer = 3 knives | 4,10 | 014.91/303F236 | 375,00 |

M

MÜLLER-MARTINI (GRAPHA)



| Maschinen-Typ Type/Type/Tipo | Abmessungen in mm Size/Dimension/Tamaño | Löcher/Holes Trous/Huecos | ⚖ kg | FASSCO-Id. Qualität/Quality/Calid. | €/Stück Pce./Pce./Pza. |
|---|---|--------------------------------|----------------|---------------------------------------|---------------------------|
| DS 250 | Vordermesser, oben 240.1424.2B 550 x 80 x 12 | 4 off.Langlö. 12/M8 4/7Ø | 3,10 | 014.94/001F236 | 255,00 |
| | | | | 014.94/001F3000 | 280,00 |
| | Seitenmesser, oben links 240.1440.3D 395 x 80 x 12 | 12/M8 4/7Ø | 2,25 | 014.94/023F236 | 170,00 |
| | | | | 014.94/023F3000 | 191,00 |
| | Seitenmesser, oben rechts 240.1440.3D 395 x 80 x 12 | 12/M8 4/7Ø | 2,25 | 014.94/023F236 | 170,00 |
| | | | | 014.94/023F3000 | 191,00 |
| | Vordermesser, unten 250.2666.1 540 x 45 x 15 | 5/M10 | 2,80 | 014.89/101F236 | 190,00 |
| Seitenmesser, unten links 250.2659.2 370 x 45 x 15 | 4/M10 | 1,75 | 014.89/123F236 | 140,00 | |
| Seitenmesser, unten rechts 250.2659.2 370 x 45 x 15 | 4/M10 | 1,75 | 014.89/123F236 | 140,00 | |
| €/Satz/Set/Jeu/Juego | | | | | |
| DS 250 | Satz Obermesser Set Upper knives | = 3 Messer = 3 knives | 7,60 | 014.94/300F236 | 595,00 |
| | Satz Obermesser Set Upper knives | = 3 Messer = 3 knives | 7,60 | 014.94/300F3000 | 662,00 |
| | Satz Untermesser Set Bottom knives | = 3 Messer = 3 knives | 6,30 | 014.89/303F236 | 470,00 |

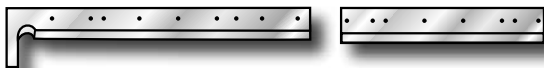

MÜLLER-MARTINI (GRAPHA)

| Maschinen-Typ Type/Type/Tipo | Abmessungen in mm Size/Dimension/Tamaño | Löcher/Holes Trous/Huecos | △ kg | FASSCO-Id. Qualität/Quality/Calid. | €/Stück Pce./Pce./Pza. |
|---|---|------------------------------|---------|---------------------------------------|---------------------------|
| DS 251 bis Serie 1.0251.0400.- .01 | Vordermesser, oben 251.2006.2C (F5) 251.2201.2 (F8) 530 x 95/65 x 8 | 7/M6 2/7 Ø | 1,83 | 014.00/001F236 | 230,00 |
| | | | | 014.00/001F3000 | 290,00 |
| | Seitenmesser, oben links 251.2005.3D (F5) 251.2200.3 (F8) 365 x 60 x 8 | 6/M6 2/7 Ø | 1,10 | 014.00/023F236 | 105,00 |
| | | | | 014.00/023F3000 | 142,00 |
| | Seitenmesser, oben rechts 251.2005.3D (F5) 251.2200.3 (F8) 365 x 60 x 8 | 6/M6 2/7 Ø | 1,10 | 014.00/023F236 | 105,00 |
| | | | | 014.00/023F3000 | 142,00 |
| | Vordermesser, unten 251.2004.3C (F5) 251.2076.3 (F8) 540 x 40 x 15/10 | 5 zyl.vers. 2/9 Ø | 1,77 | 014.00/101F236 | 151,00 |
| | Seitenmesser, unten links 251.2003.3B (F5) 251.2075.3 (F8) 372 x 40 x 15/10 | 3 zyl.vers. 2/9 Ø | 1,22 | 014.95/123F236 | 138,00 |
| | Seitenmesser, unten rechts 251.2003.3B (F5) 251.2075.3 (F8) 372 x 40 x 15/10 | 3 zyl.vers. 2/9 Ø | 1,22 | 014.95/123F236 | 138,00 |
| | €/Satz/Set/Jeu/Juego | | | | |
| DS 251 bis Serie 1.0251.0400.- .01 | Satz Obermesser Set Upper knives | = 3 Messer = 3 knives | 4,03 | 014.00/300F236 | 440,00 |
| | Satz Obermesser Set Upper knives | = 3 Messer = 3 knives | 4,03 | 014.00/300F3000 | 574,00 |
| | Satz Untermesser Set Bottom knives | = 3 Messer = 3 knives | 4,21 | 014.95/303F236 | 427,00 |

M

MÜLLER-MARTINI (GRAPHA)

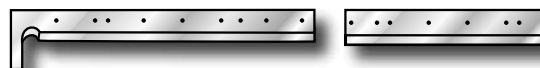

| Maschinen-Typ Type/Type/Tipo | Abmessungen in mm Size/Dimension/Tamaño | Löcher/Holes Trous/Huecos | △ kg | FASSCO-Id. Qualität/Quality/Calid. | €/Stück Pce./Pce./Pza. |
|--|--|------------------------------------|---------|---------------------------------------|---------------------------|
| DS 251 ab Serie 1.0251.0400.- .02 bis 1.0251.0400.- .07 Anleger: 235/5 235/8, 300, 335 | Vordermesser, oben 251.2006.2C (F5) 251.2201.2 (F8) 530 x 95/65 x 8 | 7/M6 2/7 Ø | 1,83 | 014.00/001F236 | 230,00 |
| | | | | 014.00/001F3000 | 290,00 |
| | Seitenmesser, oben links 251.2005.3D (F5) 251.2200.3 (F8) 365 x 60 x 8 | 6/M6 2/7 Ø | 1,10 | 014.00/023F236 | 105,00 |
| | | | | 014.00/023F3000 | 142,00 |
| | Seitenmesser, oben rechts 251.2005.3D (F5) 251.2200.3 (F8) 365 x 60 x 8 | 6/M6 2/7 Ø | 1,10 | 014.00/023F236 | 105,00 |
| | | | | 014.00/023F3000 | 142,00 |
| | Vordermesser, unten 251.2004.3C (F5) 251.2076.3 (F8) 540 x 40 x 15/10 | 5 zyl.vers. 2/9 Ø | 1,77 | 014.00/101F236 | 151,00 |
| | Seitenmesser, unten links 251.2074.3D (F5) 251.2082.3 (F8) 372 x 25,5 x 15 | 5 zyl.vers. Langlöcher 2/9 Ø | 0,89 | 014.00/102F236 | 138,00 |
| | Seitenmesser, unten rechts 251.2073.3D (F5) 251.2083.3 (F8) 372 x 25,5 x 15 | 5 zyl.vers. Langlöcher 2/9 Ø | 0,89 | 014.00/103F236 | 138,00 |
| | €/Satz/Set/Jeu/Juego | | | | |
| DS 251 ab Serie 1.0251.0400.- .02 bis 1.0251.0400.- .07 Anleger: 235/5 235/8, 300, 335 | Satz Obermesser Set Upper knives | = 3 Messer = 3 knives | 4,03 | 014.00/300F236 | 440,00 |
| | Satz Obermesser Set Upper knives | = 3 Messer = 3 knives | 4,03 | 014.00/300F3000 | 574,00 |
| | Satz Untermesser Set Bottom knives | = 3 Messer = 3 knives | 4,21 | 014.00/303F236 | 427,00 |

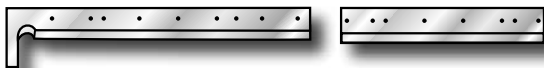

MÜLLER-MARTINI (GRAPHA)

| Maschinen-Typ Type/Type/Tipo | Abmessungen in mm Size/Dimension/Tamaño | Löcher/Holes Trous/Huecos | △ kg | FASSCO-Id. Qualität/Quality/Calid. | €/Stück Pce./Pce./Pza. |
|--|--|------------------------------------|---------|---------------------------------------|---------------------------|
| DS 251 ab Serie 1.0251.0400.- .08 (8/80) Anleger: 235/5 235/8, 300, 335 | Vordermesser, oben 251.2119.2C (F5) 251.2118.2 (F8) 550 x 90/65 x 8 | 8/M6 2/7 Ø | 1,86 | 014.92/001F236 | 230,00 |
| | | | | 014.92/001F3000 | 290,00 |
| | Seitenmesser, oben links 251.2005.3D (F5) 251.2200.3 (F8) 365 x 60 x 8 | 6/M6 2/7 Ø | 1,10 | 014.00/023F236 | 105,00 |
| | | | | 014.00/023F3000 | 142,00 |
| | Seitenmesser, oben rechts 251.2005.3D (F5) 251.2200.3 (F8) 365 x 60 x 8 | 6/M6 2/7 Ø | 1,10 | 014.00/023F236 | 105,00 |
| | | | | 014.00/023F3000 | 142,00 |
| | Vordermesser, unten 251.2116.3A (F5) 251.2115.3 (F8) 555 x 40 x 15/10 | 5 zyl.vers. 2/9 Ø | 1,82 | 014.92/101F236 | 151,00 |
| | Seitenmesser, unten links 251.2074.3D (F5) 251.2082.3 (F8) 372 x 25,5 x 15 | 5 zyl.vers. Langlöcher 2/9 Ø | 0,89 | 014.00/102F236 | 138,00 |
| | Seitenmesser, unten rechts 251.2073.3D (F5) 251.2083.3 (F8) 372 x 25,5 x 15 | 5 zyl.vers. Langlöcher 2/9 Ø | 0,89 | 014.00/103F236 | 138,00 |
| | €/Satz/Set/Jeu/Juego | | | | |
| DS 251 ab Serie 1.0251.0400.- .08 (8/80) Anleger: 235/5 235/8, 300, 335 | Satz Obermesser Set Upper knives | = 3 Messer = 3 knives | 4,06 | 014.92/300F236 | 440,00 |
| | Satz Obermesser Set Upper knives | = 3 Messer = 3 knives | 4,06 | 014.92/300F3000 | 574,00 |
| | Satz Untermesser Set Bottom knives | = 3 Messer = 3 knives | 3,60 | 014.92/303F236 | 427,00 |

M

MÜLLER-MARTINI (GRAPHA)

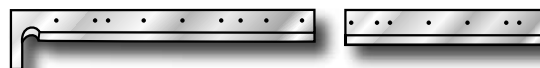

| Maschinen-Typ Type/Type/Tipo | Abmessungen in mm Size/Dimension/Tamaño | Löcher/Holes Trous/Huecos | kg | FASSCO-Id. Qualität/Quality/Calid. | €/Stück Pce./Pce./Pza. |
|------------------------------------|--|------------------------------------|------|---------------------------------------|---------------------------|
| DS 251 50mm Schnitt 50mm Cut | Vordermesser, oben 251.2119.2C (F5) 251.2118.2 (F8) 550 x 90/65 x 8 | 8/M6 2/7 Ø | 1,86 | 014.92/001F236 | 230,00 |
| | | | | 014.92/001F3000 | 290,00 |
| | Seitenmesser, oben links 251.2154.3 (F5) 251.2091.3 (F8) 377 x 60 x 8 | 6/M6 2/7 Ø | 1,10 | 014.00/004F236 | 136,00 |
| | | | | 014.00/004F3000 | 176,00 |
| | Seitenmesser, oben rechts 251.2155.3 (F5) 251.2090.3 (F8) 377 x 60 x 8 | 6/M6 2/7 Ø | 1,10 | 014.00/005F236 | 136,00 |
| | | | | 014.00/005F3000 | 176,00 |
| | Vordermesser, unten 251.2116.3A (F5) 251.2115.3 (F8) 555 x 40 x 15/10 | 5 zyl.vers. 2/9 Ø | 1,82 | 014.92/101F236 | 151,00 |
| | Seitenmesser, unten links 251.2089.3B (F5) 251.2156.3 (F8) 384 x 25,5 x 15 | 5 zyl.vers. Langlöcher 2/9 Ø | 0,90 | 014.00/104F236 | 145,00 |
| | Seitenmesser, unten rechts 251.2088.3B (F5) 251.2157.3 (F8) 384 x 25,5 x 15 | 5 zyl.vers. Langlöcher 2/9 Ø | 0,90 | 014.00/105F236 | 145,00 |
| €/Satz/Set/Jeu/Juego | | | | | |
| DS 251 50mm Schnitt 50mm Cut | Satz Obermesser Set Upper knives | = 3 Messer = 3 knives | 4,06 | 014.92A/300F236 | 502,00 |
| | Satz Obermesser Set Upper knives | = 3 Messer = 3 knives | 4,06 | 014.92A/300F3000 | 642,00 |
| | Satz Untermesser Set Bottom knives | = 3 Messer = 3 knives | 3,62 | 014.92A/303F236 | 441,00 |

| Maschinen-Typ Type/Type/Tipo | Abmessungen in mm Size/Dimension/Tamaño | Löcher/Holes Trous/Huecos | kg | FASSCO-Id. Qualität/Quality/Calid. | €/Stück Pce./Pce./Pza. |
|---|--|---|------|---------------------------------------|---------------------------|
| DS 251 Sondermesser americ.project. | Seitenmesser, unten links 1251.8968.3 372 x 25,5 x 15 | 5 zyl.vers. Langlöcher 1/9 Ø mit Ausfr. | 0,85 | 014.87/102F236 | 155,00 |
| | Seitenmesser, unten rechts 1251.8969.3 372 x 25,5 x 15 | 5 zyl. vers. Langlöcher 1/9 Ø mit Ausfr. | 0,85 | 014.87/103F236 | 155,00 |



MÜLLER-MARTINI (GRAPHA)

| Maschinen-Typ Type/Type/Tipo | Abmessungen in mm Size/Dimension/Tamaño | Löcher/Holes Trous/Huecos | △ kg | FASSCO-Id. Qualität/Quality/Calid. | €/Stück Pce./Pce./Pza. |
|---|--|------------------------------------|----------------|---------------------------------------|---------------------------|
| DS 304 Anleger 301 TEMPO | Vordermesser, oben 304.2236.2 (F5) 304.2237.2 (F8) 390 x 60 x 8 | 6 Langlöcher 5/M8 2/7 Ø | 1,11 | 014.88/001F236 | 168,00 |
| | | | | 014.88/001F3000 | 178,00 |
| | Seitenmesser, oben links 304.2234.3B (F5) 304.2235.3 (F8) 280 x 60 x 8 | 6 Langlöcher 5/M8 | 0,80 | 014.88/023F236 | 139,00 |
| | | | | 014.88/023F3000 | 146,00 |
| | Seitenmesser, oben rechts 304.2234.3B (F5) 304.2235.3 (F8) 280 x 60 x 8 | 6 Langlöcher 5/M8 | 0,80 | 014.88/023F236 | 139,00 |
| | | | | 014.88/023F3000 | 146,00 |
| | Vordermesser, unten 304.2232.2B (F5) 304.2233.2 (F8) 400 x 40 x 15 | 6 zyl.vers. Langlöcher 2/9 Ø | 1,41 | 014.88/101F236 | 200,00 |
| Seitenmesser, unten links 304.2230.3 (F5) 304.2231.3 (F8) 295 x 32 x 15 | 5 zyl.vers. Langlöcher 2/9 Ø | 0,89 | 014.88/123F236 | 158,00 | |
| Seitenmesser, unten rechts 304.2230.3 (F5) 304.2231.3 (F8) 295 x 32 x 15 | 5 zyl.vers. Langlöcher 2/9 Ø | 0,89 | 014.88/123F236 | 158,00 | |
| €/Satz/Set/Jeu/Juego | | | | | |
| DS 304 Anleger 301 TEMPO | Satz Obermesser Set Upper knives | = 3 Messer = 3 knives | 2,71 | 014.88/300F236 | 446,00 |
| | Satz Obermesser Set Upper knives | = 3 Messer = 3 knives | 2,71 | 014.88/300F3000 | 470,00 |
| | Satz Untermesser Set Bottom knives | = 3 Messer = 3 knives | 3,19 | 014.88/303F236 | 516,00 |

| Maschinen-Typ Type/Type/Tipo | Abmessungen in mm Size/Dimension/Tamaño | Löcher/Holes Trous/Huecos | △ kg | FASSCO-Id. Qualität/Quality/Calid. | €/Stück Pce./Pce./Pza. |
|---|--|------------------------------|---------|---------------------------------------|---------------------------|
| DS 304 Anleger 301 TEMPO Sondermodell special type | Seitenmesser, oben links 304.2442.3 (F8) 280 x 60 x 8 | 6 Langlöcher 5/M8 | 0,80 | 014.88/002F236 | * |
| | | | | 014.88/002F3000 | * |
| | Seitenmesser, oben rechts 304.2443.3 (F8) 280 x 60 x 8 | 6 Langlöcher 5/M8 | 0,80 | 014.88/003F236 | * |
| | | | | 014.88/003F3000 | * |

MÜLLER-MARTINI (GRAPHA)

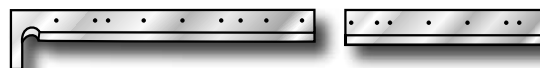

| Maschinen-Typ Type/Type/Tipo | Abmessungen in mm Size/Dimension/Tamaño | Löcher/Holes Trous/Huecos | △ kg | FASSCO-Id. Qualität/Quality/Calid. | €/Stück Pce./Pce./Pza. |
|---------------------------------------|---|------------------------------------|---------|---------------------------------------|---------------------------|
| DS 360 PRIMA 0360.0401 | Vordermesser, oben 251.2119.2C (F5) 251.2118.2 (F8) 550 x 90/65 x 8 | 8/M6 2/7 Ø | 1,86 | 014.92/001F236 | 230,00 |
| | | | | 014.92/001F3000 | 290,00 |
| | Seitenmesser, oben links 360.3424.3A (F5) 360.3425.3 (F8) 320 x 65 x 8 | 6/M6 2/7 Ø | 1,11 | 014.36/023F236 | 105,00 |
| | | | | 014.36/023F3000 | 125,00 |
| | Seitenmesser, oben rechts 360.3424.3A (F5) 360.3425.3 (F8) 320 x 65 x 8 | 6/M6 2/7 Ø | 1,11 | 014.36/023F236 | 105,00 |
| | | | | 014.36/023F3000 | 125,00 |
| | Vordermesser, unten 360.3422.2C (F5) 360.3423.2 (F8) 550 x 40 x 15 | 8 zyl.vers. Langlöcher 2/9 Ø | 2,05 | 014.36/101F236 | 227,00 |
| | Seitenmesser, unten links 360.3420.2G (F5) 360.3421.3 (F8) 380 x 32 x 15/13,7 | 5 zyl.vers. Langlöcher 2/9 Ø | 1,05 | 014.36/123F236 | 175,00 |
| | Seitenmesser, unten rechts 360.3420.2G (F5) 360.3421.3 (F8) 380 x 32 x 15/13,7 | 5 zyl.vers. Langlöcher 2/9 Ø | 1,05 | 014.36/123F236 | 175,00 |
| €/Satz/Set/Jeu/Juego | | | | | |
| DS 360 PRIMA | Satz Obermesser Set Upper knives | = 3 Messer = 3 knives | 4,08 | 014.36/300F236 | 440,00 |
| | Satz Obermesser Set Upper knives | = 3 Messer = 3 knives | 4,08 | 014.36/300F3000 | 540,00 |
| | Satz Untermesser Set Bottom knives | = 3 Messer = 3 knives | 4,15 | 014.36/303F236 | 577,00 |



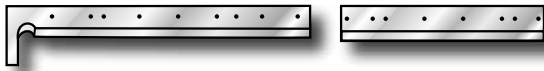

MÜLLER-MARTINI (GRAPHA)

| Maschinen-Typ Type/Type/Tipo | Abmessungen in mm Size/Dimension/Tamaño | Löcher/Holes Trous/Huecos | △ kg | FASSCO-Id. Qualität/Quality/Calid. | €/Stück Pce./Pce./Pza. |
|---|--|------------------------------------|----------------|---------------------------------------|---------------------------|
| DS 361 BRAVO Anleger: 390/370 380/0400 0449.0430 | Vordermesser, oben 251.2119.2C (F5) 251.2118.2 (F8) 550 x 90/65 x 8 | 8/M6 2/7 Ø | 1,86 | 014.92/001F236 | 230,00 |
| | | | | 014.92/001F3000 | 290,00 |
| | Seitenmesser, oben links 360.3424.3A (F5) 360.3425.3 (F8) 320 x 65 x 8 | 6/M6 2/7 Ø | 1,11 | 014.36/023F236 | 105,00 |
| | | | | 014.36/023F3000 | 125,00 |
| | Seitenmesser, oben rechts 360.3424.3A (F5) 360.3425.3 (F8) 320 x 65 x 8 | 6/M6 2/7 Ø | 1,11 | 014.36/023F236 | 105,00 |
| | | | | 014.36/023F3000 | 125,00 |
| | Vordermesser, unten 360.3422.2C (F5) 360.3423.2. (F8) 550 x 40 x 15 | 8 zyl.vers. Langlöcher 2/9 Ø | 2,05 | 014.36/101F236 | 227,00 |
| Seitenmesser, unten links 0361.4401.2 (F5) 0361.4402.2 (F8) 380 x 32 x 14,75/13,7 | 5 zyl.vers. Langlöcher 2/9 Ø | 1,05 | 014.36/167F236 | 175,00 | |
| Seitenmesser, unten rechts 0361.4401.2 (F5) 0361.4402.2 (F8) 380 x 32 x 14,75/13,7 | 5 zyl.vers. Langlöcher 2/9 Ø | 1,05 | 014.36/167F236 | 175,00 | |
| €/Satz/Set/Jeu/Juego | | | | | |
| DS 361 BRAVO 449 | Satz Obermesser Set Upper knives | = 3 Messer = 3 knives | 4,08 | 014.36/300F236 | 440,00 |
| | Satz Obermesser Set Upper knives | = 3 Messer = 3 knives | 4,08 | 014.36/300F3000 | 540,00 |
| | Satz Untermesser Set Bottom knives | = 3 Messer = 3 knives | 4,15 | 014.36A/303F236 | 577,00 |

| Maschinen-Typ Type/Type/Tipo | Abmessungen in mm Size/Dimension/Tamaño | Löcher/Holes Trous/Huecos | △ kg | FASSCO-Id. Qualität/Quality/Calid. | €/Stück Pce./Pce./Pza. |
|---|---|------------------------------------|---------|---------------------------------------|---------------------------|
| Sondermesser für Kleinstfor- mat Special knife for small sizes | Vordermesser, unten 0361.3171.2 550 x 28 x 15 | 8 zyl.vers. Langlöcher 2/9 Ø | 1,45 | 014.36/161F236 | 195,00 |

MÜLLER-MARTINI (GRAPHA)



| Maschinen-Typ Type/Type/Tipo | Abmessungen in mm Size/Dimension/Tamaño | Löcher/Holes Trous/Huecos | kg | FASSCO-Id. Qualität/Quality/Calid. | €/Stück Pce./Pce./Pza. |
|---------------------------------|--|------------------------------|------|---------------------------------------|---------------------------|
| 0404 OPTIMA | Vordermesser, oben 0404.4410.2 (F5) 0404.4413.2 (F8) 550 x 40 x 15 | 8/M8 2/Ø9 | 2,45 | 014.04/001F236 | * |
| | Seitenmesser, oben links 0404.4423.3 (F5) 0404.4408.3 (F8) 510 x 36 x 15 | 7 vers. Lö. 2/Ø9 | 1,85 | 014.04/023F236 | * |
| | Seitenmesser, oben rechts 0404.4423.3 (F5) 0404.4408.3 (F8) 510 x 36 x 15 | 7 vers. Lö. 2/Ø9 | 1,85 | 014.04/023F236 | * |
| | Vordermesser, unten 0404.4400.2 (F5) 0404.4407.2 (F8) 540 x 67 x 8 | 20/M6 2/M5 2/Ø7 | 1,85 | 014.04/101F236 | * |
| | Seitenmesser, unten links 0404.4401.3 (F5) 0404.4406.2 (F8) 360 x 67 x 8 | 14/M6 2/M5 | 1,20 | 014.04/123F236 | * |
| | Seitenmesser, unten rechts 0404.4401.3 (F5) 0404.4406.2 (F8) 360 x 67 x 8 | 14/M6 2/M5 | 1,20 | 014.04/123F236 | * |
| €/Satz/Set/Jeu/Juego | | | | | |
| 0404 OPTIMA | Satz Obermesser Set Upper knives | = 3 Messer = 3 knives | 6,15 | 014.04/300F236 | * |
| | Satz Untermesser Set Bottom knives | = 3 Messer = 3 knives | 4,25 | 014.04/303F236 | * |



MÜLLER-MARTINI (GRAPHA)

| Maschinen-Typ Type/Type/Tipo | Abmessungen in mm Size/Dimension/Tamaño | Löcher/Holes Trous/Huecos | ⚖ kg | FASSCO-Id. Qualität/Quality/Calid. | €/Stück Pce./Pce./Pza. |
|---|---|------------------------------|---------|---------------------------------------|---------------------------|
| DS 426 SUPRA Kurbelschneider | Vordermesser, oben 0426.5460.2 (F8) 360 x 110/105,3 x 10 | 7 Langlöcher 3/M8 2/M5 | 2,75 | 014.81/001F8000 | * |
| | Seitenmesser, oben links 0426.3155.2 (F8) 300 x 110 x 10 | 5 Langlöcher 2/M8 2/M5 | 2,30 | 014.81/002F8000 | * |
| | Seitenmesser, oben rechts 0426.3154.2 (F8) 300 x 110 x 10 | 5 Langlöcher 2/M8 2/M5 | 2,30 | 014.81/003F8000 | * |
| | Vordermesser, unten 0426.3254.3 (F8) 360 x 32 x 15 | 6 zyl.vers. Langlöcher | 1,10 | 014.81/101F8000 | * |
| | Seitenmesser, unten links 0426.3136.2 (F8) 302 x 32 x 15 | 5 zyl.vers. Langlöcher | 0,90 | 014.81/102F8000 | * |
| | Seitenmesser, unten rechts 0426.3137.2 (F8) 302 x 32 x 15 | 5 zyl.vers. Langlöcher | 0,90 | 014.81/103F8000 | * |
| €/Satz/Set/Jeu/Juego | | | | | |
| DS 426 SUPRA Kurbelschneider | Satz Obermesser Set Upper knives | = 3 Messer = 3 knives | 7,35 | 014.81/300F8000 | * |
| | Satz Untermesser Set Bottom knives | = 3 Messer = 3 knives | 2,90 | 014.81/303F8000 | * |

M

MÜLLER-MARTINI (GRAPHA)

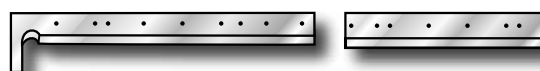

| Maschinen-Typ Type/Type/Tipo | Abmessungen in mm Size/Dimension/Tamaño | Löcher/Holes Trous/Huecos | △ kg | FASSCO-Id. Qualität/Quality/Calid. | €/Stück Pce./Pce./Pza. |
|---|---|-----------------------------------|---------|---------------------------------------|---------------------------|
| DS 449 449 0435 Bravo Plus Amrys | Vordermesser, oben 251.2119.2C (F5) 251.2118.2 (F8) 550 x 90/65 x 8 | 8/M6 2/7Ø | 1,86 | 014.92/001F236 | 230,00 |
| | | | | 014.92/001F3000 | 290,00 |
| | Seitenmesser, oben links 360.3424.3A (F5) 360.3425.3 (F8) 320 x 65 x 8 | 6/M6 2/7Ø | 1,11 | 014.36/023F236 | 105,00 |
| | | | | 014.36/023F3000 | 125,00 |
| | Seitenmesser, oben rechts 360.3424.3A (F5) 360.3425.3 (F8) 320 x 65 x 8 | 6/M6 2/7Ø | 1,11 | 014.36/023F236 | 105,00 |
| | | | | 014.36/023F3000 | 125,00 |
| | Vordermesser, unten 360.3422.2C (F5) 360.3423.2 (F8) 550 x 40 x 15 | 8 zyl.vers. Langlöcher 2/9Ø | 2,05 | 014.36/101F236 | 227,00 |
| | Seitenmesser, unten links 0361.4407.2 (F5) 0361.4409.2 (F8) 383 x 32 x 14,75/13,7 | 5 zyl.vers. Langlöcher 2/9Ø | 1,05 | 014.44/102F236 | 175,00 |
| | Seitenmesser, unten rechts 0361.4408.2 (F5) 0361.4410.2 (F8) 383 x 32 x 14,75/13,7 | 5 zyl.vers. Langlöcher 2/9Ø | 1,05 | 014.44/103F236 | 175,00 |
| €/Satz/Set/Jeu/Juego | | | | | |
| DS 449 449 0435 Bravo Plus Amrys | Satz Obermesser Set Upper knives | = 3 Messer = 3 knives | 4,08 | 014.36/300F236 | 440,00 |
| | Satz Obermesser Set Upper knives | = 3 Messer = 3 knives | 4,08 | 014.36/300F3000 | 540,00 |
| | Satz Untermesser Set Bottom knives | = 3 Messer = 3 knives | 4,15 | 014.44/303F236 | 577,00 |

(Sonderausführung / Special Model)

| Maschinen-Typ Type/Type/Tipo | Abmessungen in mm Size/Dimension/Tamaño | Löcher/Holes Trous/Huecos | △ kg | FASSCO-Id. Qualität/Quality/Calid. | €/Stück Pce./Pce./Pza. |
|---------------------------------|--|------------------------------------|---------|---------------------------------------|---------------------------|
| DS 449 | Seitenmesser, oben links 361.4412.2 340 x 65 x 8 | 6/M6 2/7 Ø | 1,16 | 014.45/002F236 | * |
| | | | | 014.45/002F3000 | * |
| | Seitenmesser, oben links 361.4411.2 340 x 65 x 8 | 6/M6 2/7 Ø | 1,16 | 014.45/003F236 | * |
| | | | | 014.45/003F3000 | * |
| | Seitenmesser, unten links 0361.4414.2 383 x 32 x 14,75/13,7 | 5 zyl.vers. Langlöcher 2/9 Ø | 1,05 | 014.44/106F236 | * |
| | | | | 014.44/107F236 | * |
| | Seitenmesser, unten rechts 0361.4413.2 383 x 32 x 14,75/13,7 | 5 zyl.vers. Langlöcher 2/9 Ø | 1,05 | 014.44/106F236 | * |
| | | | | 014.44/107F236 | * |

014.38/104
014.38/105014.38/102
014.38/103**MÜLLER-MARTINI (GRAPHA)**

| Maschinen-Typ Type/Type/Tipo | Abmessungen in mm Size/Dimension/Tamaño | Löcher/Holes Trous/Huecos | △ ⁺ △ kg | FASSCO-Id. Qualität/Quality/Calid. | €/Stück Pce./Pce./Pza. |
|--|---|------------------------------------|------------------------|---------------------------------------|---------------------------|
| DS 459 PRIMERA 130/140/160 | Vordermesser, oben 0251.2119.2 (F5) 0251.2118.2 (F8) 550 x 90/65 x 8 | 8/M6 2/7 Ø | 1,86 | 014.92/001F236 | 230,00 |
| | | | | 014.92/001F3000 | 290,00 |
| | Seitenmesser, oben links 0459.3467.3 (F5) 0459.4413.3 (F8) 329,5 x 65 x 8 | 6/M6 2/7 Ø | 1,12 | 014.38/002F236 | 120,00 |
| | | | | 014.38/002F3000 | 150,00 |
| | Seitenmesser, oben rechts 0459.3468.3 (F5) 0459.4414.3 (F8) 329,5 x 65 x 8 | 6/M6 2/7 Ø | 1,12 | 014.38/003F236 | 120,00 |
| | | | | 014.38/003F3000 | 150,00 |
| | Vordermesser, unten 0459.4401.2 (F5) 0459.4412.2 (F8) 550 x 33 x 15 | 8 zyl.vers. Langlöcher 2/9 Ø | 1,90 | 014.38/101F236 | 219,00 |
| Seitenmesser, unten links 0459.4409.2B (F5) 0459.4411.2 (F8) 332,5x22,5x15 | 5 zyl.vers. Langlöcher 2/9 Ø | 0,80 | 014.38/104F236 | 159,00 | |
| Seitenmesser, unten rechts 0459.4408.2B (F5) 0459.4410.2 (F8) 332,5x22,5x15 | 5 zyl.vers. Langlöcher 2/9 Ø | 0,80 | 014.38/105F236 | 159,00 | |
| €/Satz/Set/Jeu/Juego | | | | | |
| DS 459 PRIMERA 130/140/160 | Satz Obermesser Set Upper knives | = 3 Messer = 3 knives | 4,10 | 014.38/300F236 | 470,00 |
| | Satz Obermesser Set Upper knives | = 3 Messer = 3 knives | 4,10 | 014.38/300F3000 | 590,00 |
| | Satz Untermesser Set Bottom knives | = 3 Messer = 3 knives | 3,50 | 014.38/303F236 | 537,00 |

(Sonderausführung / Special Model)

| Maschinen-Typ Type/Type/Tipo | Abmessungen in mm Size/Dimension/Tamaño | Löcher/Holes Trous/Huecos | △ ⁺ △ kg | FASSCO-Id. Qualität/Quality/Calid. | €/Stück Pce./Pce./Pza. |
|--|---|------------------------------------|------------------------|---------------------------------------|---------------------------|
| DS 459 PRIMERA altes Modell old Model | Seitenmesser, unten links 0459.4409.2 (F5) 0459.4411.2 (F8) 333,5x22,5x15 | 5 zyl.vers. Langlöcher 2/9 Ø | 0,80 | 014.38/102F236 | 159,00 |
| | Seitenmesser, unten rechts 0459.4408.2 (F5) 0459.4410.2 (F8) 333,5x22,5x15 | 5 zyl.vers. Langlöcher 2/9 Ø | 0,80 | 014.38/103F236 | 159,00 |

MÜLLER-MARTINI (GRAPHA, VIRGINIA/USA)



| Maschinen-Typ Type/Type/Tipo | Abmessungen in mm Size/Dimension/Tamaño | Löcher/Holes Trous/Huecos | △ ⁺ △ ₋ kg | FASSCO-Id. Qualität/Quality/Calid. | €/Stück Pce./Pce./Pza. |
|--|---|------------------------------|-------------------------------------|---------------------------------------|---------------------------|
| 1522 Anleger: 1509 Hefter: PRESTO Minuteman | Vordermesser, oben 1522.1049.2A 420 x 74,5/65,5 x 6 | 12/M6 2/7 Ø | 1,18 | 064.90/001F236 | 135,00 |
| | | | | 064.90/001F3000 | 185,00 |
| | Seitenmesser, oben links 890.0536.3B (F5) 890.0544.3 (F8) 355 x 65/55 x 6 | 16/M6 2/7 Ø | 0,84 | 014.99/002F236 | 102,00 |
| | | | | 014.99/002F3000 | 145,00 |
| | Seitenmesser, oben rechts 890.0537.3B (F5) 890.0543.3 (F8) 355 x 65/55 x 6 | 16/M6 2/7 Ø | 0,84 | 014.99/003F236 | 102,00 |
| | | | | 014.99/003F3000 | 145,00 |
| | Vordermesser, unten 1522.1050.3C 420 x 30 x 18 | 4 zyl.vers. Langlöcher | 1,51 | 064.90/101F236 | 135,00 |
| Seitenmesser, unten links 1522.1272.3C 360 x 23,5 x 15 | 4/M8 | 0,88 | 064.90/102F236 | 95,00 | |
| Seitenmesser, unten rechts 1522.1271.3C 360 x 23,5 x 15 | 4/M8 | 0,88 | 064.90/103F236 | 95,00 | |
| €/Satz/Set/Jeu/Juego | | | | | |
| 1522 Anleger: 1509 Hefter: PRESTO Minuteman | Satz Obermesser Set Upper knives | = 3 Messer = 3 knives | 2,86 | 064.90/300F236 | 339,00 |
| | Satz Obermesser Set Upper knives | = 3 Messer = 3 knives | 2,86 | 064.90/300F3000 | 475,00 |
| | Satz Untermesser Set Bottom knives | = 3 Messer = 3 knives | 3,27 | 064.90/303F236 | 325,00 |

(Sonderausführung / Special Model)

| Maschinen-Typ Type/Type/Tipo | Abmessungen in mm Size/Dimension/Tamaño | Löcher/Holes Trous/Huecos | △ ⁺ △ ₋ kg | FASSCO-Id. Qualität/Quality/Calid. | €/Stück Pce./Pce./Pza. |
|---------------------------------|---|------------------------------|-------------------------------------|---------------------------------------|---------------------------|
| 1522 | Vordermesser, oben 1522.1154.2 420 x 140/74,5/65,5 x 6 | 12/M6 2/7 Ø | 1,22 | 064.92/001F236 | * |
| | Seitenmesser, unten links 1522.1310.3B 360 x 23,5 x 15 | 3/M8 mit Ausfr. | 0,78 | 064.91/102F236 | * |
| | Seitenmesser, unten rechts 1522.1309.3B 360 x 23,5 x 15 | 3/M8 mit Ausfr. | 0,78 | 064.91/103F236 | * |



MÜLLER-MARTINI (GRAPHA, VIRGINIA/USA)

| Maschinen-Typ Type/Type/Tipo | Abmessungen in mm Size/Dimension/Tamaño | Löcher/Holes Trous/Huecos | △ kg | FASSCO-Id. Qualität/Quality/Calid. | €/Stück Pce./Pce./Pza. |
|--|--|-----------------------------------|---------|---------------------------------------|---------------------------|
| 1537 altes Modell old Model | Vordermesser, oben 1537.1165.2 420 x 80/70 x 10 | 8 zyl.vers. Langlöcher | 1,80 | 064.93/001F236 | * |
| | Seitenmesser, oben links 1537.1091.3 330,5 x 80/70 x 10 | 6 zyl.vers. Langlöcher | 1,40 | 064.93/002F236 | * |
| | Seitenmesser, oben rechts 1537.1092.3 330,5 x 80/70 x 10 | 6 zyl.vers. Langlöcher | 1,40 | 064.93/003F236 | * |
| | Vordermesser, unten 1537.1163.2B 444 x 30 x 25 | 8 zyl.vers. Langlöcher 2/M6 | 2,00 | 064.93/101F236 | * |
| | Seitenmesser, unten links 1537.1139.2 386 x 25 x 20 | 4/M8 | 1,35 | 064.93/102F236 | * |
| | Seitenmesser, unten rechts 1537.1140.2 386 x 25 x 20 | 4/M8 | 1,35 | 064.93/103F236 | * |
| €/Satz/Set/Jeu/Juego | | | | | |
| 1537 altes Modell old Model | Satz Obermesser Set Upper knives | = 3 Messer = 3 knives | 4,60 | 064.93/300F236 | * |
| | Satz Untermesser Set Bottom knives | = 3 Messer = 3 knives | 4,70 | 064.93/303F236 | * |

| Maschinen-Typ Type/Type/Tipo | Abmessungen in mm Size/Dimension/Tamaño | Löcher/Holes Trous/Huecos | △ kg | FASSCO-Id. Qualität/Quality/Calid. | €/Stück Pce./Pce./Pza. |
|--|---|-----------------------------------|---------|---------------------------------------|---------------------------|
| 1537 neues Modell new Model | Vordermesser, oben 1537.1857.2A 420 x 88/70 x 12 | 8 zyl.vers. Langlöcher | 2,05 | 064.94/001F236 | * |
| | Seitenmesser, oben links 1537.1856.3A 327,5 x 87/70 x 12 | 7 zyl.vers. Langlöcher | 1,55 | 064.94/002F236 | * |
| | Seitenmesser, oben rechts 1537.1855.3A 327,5 x 87/70 x 12 | 7 zyl.vers. Langlöcher | 1,55 | 064.94/003F236 | * |
| | Vordermesser, unten 1537.1163.2B 444 x 30 x 25 | 8 zyl.vers. Langlöcher 2/M6 | 2,00 | 064.93/101F236 | * |
| | Seitenmesser, unten links 1537.1139.2 386 x 25 x 20 | 4/M8 | 1,35 | 064.93/102F236 | * |
| | Seitenmesser, unten rechts 1537.1140.2 386 x 25 x 20 | 4/M8 | 1,35 | 064.93/103F236 | * |
| €/Satz/Set/Jeu/Juego | | | | | |
| 1537 neues Modell new Model | Satz Obermesser Set Upper knives | = 3 Messer = 3 knives | 5,15 | 064.94/300F236 | * |
| | Satz Untermesser Set Bottom knives | = 3 Messer = 3 knives | 4,70 | 064.93/303F236 | * |

MÜLLER-MARTINI (GRAPHA)



| Maschinen-Typ Type/Type/Tipo | Abmessungen in mm Size/Dimension/Tamaño | Löcher/Holes Trous/Huecos | △ kg | FASSCO-Id. Qualität/Quality/Calid. | €/Stück Pce./Pce./Pza. |
|---------------------------------|---|------------------------------|---------|---------------------------------------|---------------------------|
| 1565 News trim | Vordermesser, oben 1565.1079.3 400 x 74/56 x 6 | 14/M6 | 1,05 | 064.97/001F236 | 178,00 |
| | Seitenmesser, oben links 1565.1077.3 340 x 66/48 x 6 | 16/M6 | 0,80 | 064.97/002F236 | 120,00 |
| | Seitenmesser, oben rechts 1565.1078.3 340 x 66/48 x 6 | 16/M6 | 0,80 | 064.97/003F236 | 120,00 |
| | Vordermesser, unten 1565.1082.3 400 x 30 x 18 | 4 zyl.vers. Langlöcher | 1,45 | 064.97/101F236 | 157,00 |
| | Seitenmesser, unten links 1565.1188.3 340 x 23 x 15 | 4/M8 | 0,85 | 064.97/123F236 | 104,00 |
| | Seitenmesser, unten rechts 1565.1188.3 340 x 23 x 15 | 4/M8 | 0,85 | 064.97/123F236 | 104,00 |
| €/Satz/Set/Jeu/Juego | | | | | |
| 1565 News trim | Satz Obermesser Set Upper knives | = 3 Messer = 3 knives | 2,65 | 064.97/300F236 | 418,00 |
| | Satz Untermesser Set Bottom knives | = 3 Messer = 3 knives | 3,15 | 064.97/303F236 | 365,00 |

MÜLLER-MARTINI (GRAPHA)

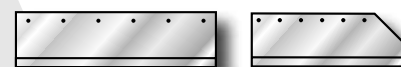

| Maschinen-Typ Type/Type/Tipo | Abmessungen in mm Size/Dimension/Tamaño | Löcher/Holes Trous/Huecos | △ kg | FASSCO-Id. Qualität/Quality/Calid. | €/Stück Pce./Pce./Pza. |
|--|--|------------------------------|---------|---------------------------------------|---------------------------|
| 1576 ESPRIT GRANIT 1576.1505.1 (F8) | Vordermesser 1576.1503.1 (F5) 501 x 110 x 12 | 6/M10 | 4,25 | 064.96/001F3000 | 358,00 |
| | Seitenmesser, links 1576.1606.1 (F5) 1576.1658.1 (F8) 410 x 112 x 12 | 5/M10 | 3,25 | 064.96/002F3000 | 338,00 |
| | Seitenmesser, rechts 1576.1619.1 (F5) 1576.1659.1 (F8) 410 x 112 x 12 | 5/M10 | 3,25 | 064.96/003F3000 | 338,00 |
| €/Satz/Set/Jeu/Juego | | | | | |
| 1576 ESPRIT GRANIT | kompletter Satz complete set | = 3 Messer = 3 knives | 10,75 | 064.96/300F3000 | 1034,00 |

| Maschinen-Typ Type/Type/Tipo | Abmessungen in mm Size/Dimension/Tamaño | Löcher/Holes Trous/Huecos | △ kg | FASSCO-Id. Qualität/Quality/Calid. | €/Stück Pce./Pce./Pza. |
|---------------------------------|---|------------------------------|---------|---------------------------------------|---------------------------|
| 1581 Blockschneider | Obermesser 1581.1711.3 360 x 75 x 15 | 6/M6 | 2,80 | 064.95/001F236 | * |
| | Untermesser 1581.1745.2 370 x 45 x 15 | 6 zyl.vers Langlöcher | 1,60 | 064.95/101F236 | * |



M

MÜLLER-MARTINI (GRAPHA)



| Maschinen-Typ Type/Type/Tipo | Abmessungen in mm Size/Dimension/Tamaño | Löcher/Holes Trous/Huecos | ⚖ kg | FASSCO-Id. Qualität/Quality/Calid. | €/Stück Pce./Pce./Pza. |
|--|--|------------------------------|---------|---------------------------------------|---------------------------|
| 3670 alte Ausfrg. old style | Vordermesser 3670.1022.2B (F3) MK: 3670.3576.3 (F3) 3670.1475.2 (F8) 560 x 80 x 12 | 12/M10 2/8,4 Ø | 3,35 | 014.51/001F3000 | 225,00 |
| | Seitenmesser, links 3670.2132.2B (F3) MK: 3670.3580.2 (F3) 3670.1874.2 (F8) 392 x 80 x 12 | 8/M10 | 1,95 | 014.51/023F3000 | 164,00 |
| | Seitenmesser, rechts 3670.2132.2B (F3) MK: 3670.3580.2 (F3) 3670.1874.2 (F8) 392 x 80 x 12 | 8/M10 | 1,95 | 014.51/023F3000 | 164,00 |
| €/Satz/Set/Jeu/Juego | | | | | |
| 3670 alte Ausfrg. old style | kompletter Satz complete set | = 3 Messer = 3 knives | 7,25 | 014.51/300F3000 | 553,00 |

| Maschinen-Typ Type/Type/Tipo | Abmessungen in mm Size/Dimension/Tamaño | Löcher/Holes Trous/Huecos | ⚖ kg | FASSCO-Id. Qualität/Quality/Calid. | €/Stück Pce./Pce./Pza. |
|--|--|------------------------------|---------|---------------------------------------|---------------------------|
| 3670 kurz/short alte Ausfrg. old style | Vordermesser 3670.2592.2 (F3) MK: 3670.3577.3 (F3) 3670.2590.2 (F8) 440 x 80 x 12 | 8/M10 | 2,70 | 014.52/001F3000 | 178,00 |
| | Seitenmesser, links 3670.2593.2A (F3) MK: 3670.3581.2 (F3) 3670.2591.2 (F8) 322 x 80 x 12 | 6/M10 | 1,55 | 014.52/023F3000 | 145,00 |
| | Seitenmesser, rechts 3670.2593.2A (F3) MK: 3670.3581.2 (F3) 3670.2591.2 (F8) 322 x 80 x 12 | 6/M10 | 1,55 | 014.52/023F3000 | 145,00 |
| €/Satz/Set/Jeu/Juego | | | | | |
| 3670 kurz/short alte Ausfrg. old style | kompletter Satz complete set | = 3 Messer = 3 knives | 5,80 | 014.52/300F3000 | 468,00 |



MÜLLER-MARTINI (GRAPHA)

| Maschinen-Typ Type/Type/Tipo | Abmessungen in mm Size/Dimension/Tamaño | Löcher/Holes Trous/Huecos | △ kg | FASSCO-Id. Qualität/Quality/Calid. | €/Stück Pce./Pce./Pza. |
|--|---|------------------------------|---------|---------------------------------------|---------------------------|
| 3670 neue Ausfrg. new style | Vordermesser 3670.4327.2 (F3) MK: 3670.4337.3 (F3) 3670.4329.2 (F8) MK: 3670.4336.3 (F8) 540 x 90 x 12 | 12/M10 | 3,75 | 014.57/001F3000 | 185,00 |
| | Seitenmesser, links 3670.4328.2 (F3) MK: 3670.4340.2 (F8) 3670.4330.2 (F3) MK: 3670.4341.2 (F8) 392 x 90 x 12 | 8/M10 | 2,25 | 014.57/023F3000 | 140,00 |
| | Seitenmesser, rechts 3670.4328.2 (F3) MK: 3670.4340.2 (F3) 3670.4330.2 (F8) MK: 3670.4341.2 (F8) 392 x 90 x 12 | 8/M10 | 2,25 | 014.57/023F3000 | 140,00 |
| €/Satz/Set/Jeu/Juego | | | | | |
| 3670 neue Ausfrg. new style | kompletter Satz complete set | = 3 Messer = 3 knives | 8,25 | 014.57/300F3000 | 465,00 |

| Maschinen-Typ Type/Type/Tipo | Abmessungen in mm Size/Dimension/Tamaño | Löcher/Holes Trous/Huecos | △ kg | FASSCO-Id. Qualität/Quality/Calid. | €/Stück Pce./Pce./Pza. |
|--|---|------------------------------|---------|---------------------------------------|---------------------------|
| 3670 kurz/short neue Ausfrg. new style | Vordermesser 3670.4489.2 (F3) MK: 3670.4491.3 (F3) 3670.4490.2 (F8) MK: 3670.4492.3 (F8) 420 x 90 x 12 | 8/M10 | 2,95 | 014.56/011F3000 | 153,00 |
| | Seitenmesser, links 3670.4360.2 (F3) MK: 3670.4342.2 (F3) 3670.4361.2 (F8) MK: 3670.4343.2 (F8) 322 x 90 x 12 | 6/M10 | 1,75 | 014.56/023F3000 | 123,00 |
| | Seitenmesser, rechts 3670.4360.2 (F3) MK: 3670.4342.2 (F3) 3670.4361.2 (F8) MK: 3670.4343.2 (F8) 322 x 90 x 12 | 6/M10 | 1,75 | 014.56/023F3000 | 123,00 |
| €/Satz/Set/Jeu/Juego | | | | | |
| 3670 kurz/short neue Ausfrg. new style | kompletter Satz complete set | = 3 Messer = 3 knives | 6,45 | 014.56/300F3000 | 399,00 |

MÜLLER-MARTINI (GRAPHA)





| Maschinen-Typ Type/Type/Tipo | Abmessungen in mm Size/Dimension/Tamaño | Löcher/Holes Trous/Huecos | ⚖️ kg | FASSCO-Id. Qualität/Quality/Calid. | €/Stück Pce./Pce./Pza. |
|------------------------------------|--|------------------------------|----------|---------------------------------------|---------------------------|
| 3671 MERIT Serie 97 | Vordermesser 3670.4327.2 (F3) MK: 3670.4337.3 (F3) 3670.5060.2 (F8) MK: 3670.5064.3 (F8) 540 x 90 x 12 | 12/M10 | 3,75 | 014.57/001F3000 | 185,00 |
| | Seitenmesser, links 3671.1760.2B (F3) MK: 3671.1762.2B (F3) 3671.1723.2 (F8) MK: 3671.1725.2.(F8) 417 x 90 x 12 | 20/M10 | 2,35 | 014.50/023F3000 | 155,00 |
| | Seitenmesser, rechts 3671.1760.2B (F3) MK: 3671.1762.2B (F3) 3671.1723.2 MK: 3671.1725.2.(F8) 417 x 90 x 12 | 20/M10 | 2,35 | 014.50/023F3000 | 155,00 |
| €/Satz/Set/Jeu/Juego | | | | | |
| 3671 MERIT Serie 97 | kompletter Satz complete set | = 3 Messer = 3 knives | 8,45 | 014.50/300F3000 | 495,00 |

| Maschinen-Typ Type/Type/Tipo | Abmessungen in mm Size/Dimension/Tamaño | Löcher/Holes Trous/Huecos | ⚖️ kg | FASSCO-Id. Qualität/Quality/Calid. | €/Stück Pce./Pce./Pza. |
|---|---|------------------------------|----------|---------------------------------------|---------------------------|
| 3671 MERIT verkürzt Serie 97 | Vordermesser 3670.4489.2 (F3) MK: 3670.4491.3 (F3) 3670.5059.2 (F8) MK: 3670.4492.3 (F8) 420 x 90 x 12 | 8/M10 | 2,95 | 014.56/011F3000 | 153,00 |
| | Seitenmesser, links 3671.1763.2B (F8) MK: 3671.1765.2B (F3) 3671.1757.2 (F8) MK: 3671.1759.2 (F8) 347 x 90 x 12 | 16/M10 | 1,92 | 014.48/023F3000 | 134,00 |
| | Seitenmesser, rechts 3671.1763.2B (F8) MK: 3671.1765.2B (F3) 3671.1757.2 (F8) MK: 3671.1759.2 (F8) 347 x 90 x 12 | 16/M10 | 1,92 | 014.48/023F3000 | 134,00 |
| €/Satz/Set/Jeu/Juego | | | | | |
| 3671 MERIT verkürzt Serie 97 | kompletter Satz complete set | = 3 Messer = 3 knives | 6,79 | 014.48/300F3000 | 421,00 |



MÜLLER-MARTINI (GRAPHA)

| Maschinen-Typ Type/Type/Tipo | Abmessungen in mm Size/Dimension/Tamaño | Löcher/Holes Trous/Huecos |  kg | FASSCO-Id. Qualität/Quality/Calid. | €/Stück Pce./Pce./Pza. |
|-------------------------------------|---|------------------------------|---|---------------------------------------|---------------------------|
| 3672 ZENITH Serie 97 | Vordermesser 3670.4327.2 (3) MK: 3670.4337.3 (F3) 3670.5060.2 (F8) MK: 3670.5064.3 (F8) 540 x 90 x 12 | 12/M10 | 3,75 | 014.57/001F3000 | 185,00 |
| | Seitenmesser, links 3672.2298.2 (F3) MK: 3672.2300.2 (F3) 3672.2125.2 (F8) MK: 3672.2127.3 (F8) 409 x 90 x 12 | 20/M10 | 2,30 | 014.57/034F3000 | 155,00 |
| | Seitenmesser, rechts 3672.2298.2 (F3) MK: 3672.2300.2 (F3) 3672.2125.2 (F8) MK: 3672.2127.3 (F8) 409 x 90 x 12 | 20/M10 | 2,30 | 014.57/034F3000 | 155,00 |
| €/Satz/Set/Jeu/Juego | | | | | |
| 3672 ZENITH Serie 97 | kompletter Satz complete set | = 3 Messer = 3 knives | 8,35 | 014.57A/300F3000 | 495,00 |

| Maschinen-Typ Type/Type/Tipo | Abmessungen in mm Size/Dimension/Tamaño | Löcher/Holes Trous/Huecos |  kg | FASSCO-Id. Qualität/Quality/Calid. | €/Stück Pce./Pce./Pza. |
|--|---|------------------------------|---|---------------------------------------|---------------------------|
| 3672 ZENITH verkürzt Serie 97 | Vordermesser 3670.4489.2 (F3) MK: 3670.4491.3 (F3) 3670.5059.2 (F8) MK: 3670.5063.3 (F8) 420 x 90 x 12 | 8/M10 | 2,95 | 014.56/011F3000 | 153,00 |
| | Seitenmesser, links 3672.2292.2 (F3) MK: 3672.2294.2 (F3) 3672.2295.2 (F8) 339 x 90 x 12 | 16/M10 | 1,85 | 014.56/034F3000 | 134,00 |
| | Seitenmesser, rechts 3672.2292.2 (F3) MK: 3672.2294.2 (F3) 3672.2295.2 (F8) 339 x 90 x 12 | 16/M10 | 1,85 | 014.56/034F3000 | 134,00 |
| €/Satz/Set/Jeu/Juego | | | | | |
| 3672 ZENITH verkürzt Serie 97 | kompletter Satz complete set | = 3 Messer = 3 knives | 6,65 | 014.56A/300F3000 | 421,00 |

MÜLLER-MARTINI (GRAPHA)



| Maschinen-Typ Type/Type/Tipo | Abmessungen in mm Size/Dimension/Tamaño | Löcher/Holes Trous/Huecos | kg | FASSCO-Id. Qualität/Quality/Calid. | €/Stück Pce./Pce./Pza. |
|---------------------------------|---|------------------------------|------|---------------------------------------|---------------------------|
| 3674 Frontero | Vordermesser 3674.1022.3 (F3) MK: 3674.1023.3 (F3) 3674.1020.3 (F8) 570 x 90 x 12 | 12/M10 | 3,95 | 014.65/001F3000 | 208,00 |

| Maschinen-Typ Type/Type/Tipo | Abmessungen in mm Size/Dimension/Tamaño | Löcher/Holes Trous/Huecos | kg | FASSCO-Id. Qualität/Quality/Calid. | €/Stück Pce./Pce./Pza. |
|---|---|------------------------------|-------|---------------------------------------|---------------------------|
| 3675 ORBIT bis Serie 02/2011 | Vordermesser 3675.1360.3 (F3) MK: 3675.3235.3 (F3) 3675.1357.3 (F8) 580 x 115 x 12 | 12/M10 1 Langloch | 5,30 | 014.47/001F3000 | 280,00 |
| | Seitenmesser, links 3675.1770.2 (F3) MK: 3675.3236.3 (F3) 3675.1755.2 (F8) 450 x 115 x 12 | 15/M10 2 Langlöcher | 3,45 | 014.47/034F3000 | 261,00 |
| | Seitenmesser, links 3675.1770.2 (F3) MK: 3675.3236.3 (F3) 3675.1755.2 (F3) 450 x 115 x 12 | 15/M10 2 Langlöcher | 3,45 | 014.47/034F3000 | 261,00 |
| €/Satz/Set/Jeu/Juego | | | | | |
| 3675 ORBIT bis Serie 02/2011 | kompletter Satz complete set | = 3 Messer = 3 knives | 12,20 | 014.47/300F3000 | 802,00 |

| Maschinen-Typ Type/Type/Tipo | Abmessungen in mm Size/Dimension/Tamaño | Löcher/Holes Trous/Huecos | kg | FASSCO-Id. Qualität/Quality/Calid. | €/Stück Pce./Pce./Pza. |
|--|---|------------------------------|-------|---------------------------------------|---------------------------|
| 3675 ORBIT ab Serie 05/2011 | Vordermesser 3675.1397.3A (F3) MK: 3675.3249.3A (F3) 3675.1396.3A (F8) MK: 3675.3248.3 (F8) 585 x 115 x 12 | 12/M10 | 5,20 | 014.27/001F3000 | 280,00 |
| | Seitenmesser, links 3675.1782.2A (F3) MK: 3675.3247.3A (F3) 3675.1781.2 (F8)) MK: 3675.3246.3 (F8) 466,6 x 115 x 12 | 15/M10 | 3,55 | 014.27/023F3000 | 261,00 |
| | Seitenmesser, rechts 3675.1782.2A (F3) MK: 3675.3247.3A (F3) 3675.1781.2 (F8)) MK: 3675.3246.3 (F8) 466,6 x 115 x 12 | 15/M10 | 3,55 | 014.27/023F3000 | 261,00 |
| €/Satz/Set/Jeu/Juego | | | | | |
| 3675 ORBIT ab Serie 05/2011 | kompletter Satz complete set | = 3 Messer = 3 knives | 12,30 | 014.27/300F3000 | 802,00 |

MÜLLER-MARTINI (GRAPHA)

| Maschinen-Typ Type/Type/Tipo | Abmessungen in mm Size/Dimension/Tamaño | Löcher/Holes Trous/Huecos | △ kg | FASSCO-Id. Qualität/Quality/Calid. | €/Stück Pce./Pce./Pza. |
|---------------------------------|---|------------------------------|---------|---------------------------------------|---------------------------|
| 3673 SOLIT | Vordermesser 3675.1397.3A (F3) MK: 3675.3249.3A (F3) 3675.1396.3A (F8) MK: 3675.3248.3 (F8) 585 x 115 x 12 | 12/M10 | 5,20 | 014.27/001F3000 | 280,00 |
| | Seitenmesser, links 3673.3452.1 (F3) MK: 3673.3453.3 (F3) 3673.3450.1 (F8) MK: 3673.3451.3 (F8) 479,1 x 115 x 12 | 15/M10 | 3,65 | 014.28/023F3000 | 265,00 |
| | Seitenmesser, links 3673.3452.1 (F3) MK: 3673.3453.3 (F3) 3673.3450.1 (F8) MK: 3673.3451.3 (F8) 479,1 x 115 x 12 | 15/M10 | 3,65 | 014.28/023F3000 | 265,00 |
| €/Satz/Set/Jeu/Juego | | | | | |
| 3673 SOLIT | kompletter Satz complete set | = 3 Messer = 3 knives | 12,50 | 014.28/300F3000 | 810,00 |



MÜLLER-MARTINI (GRAPHA)

M

| Maschinen-Typ Type/Type/Tipo | Abmessungen in mm Size/Dimension/Tamaño | Löcher/Holes Trous/Huecos | △ kg | FASSCO-Id. Qualität/Quality/Calid. | €/Stück Pce./Pce./Pza. |
|--|---|------------------------------|---------|---------------------------------------|---------------------------|
| DSS 890 241/251 MS-Lg. 350 Trennen Split cut | Obermesser 890.2623.3D 350 x 95/81/60 x 6 | 5 Langlöcher | 0,97 | 014.64F236 | 212,00 |
| | Untermesser 890.2622.3E 350 x 58 x 10/6 | 7/M6 2/7 Ø | 0,98 | 014.69/104F236 | 195,00 |

| Maschinen-Typ Type/Type/Tipo | Abmessungen in mm Size/Dimension/Tamaño | Löcher/Holes Trous/Huecos | △ kg | FASSCO-Id. Qualität/Quality/Calid. | €/Stück Pce./Pce./Pza. |
|--|---|------------------------------|---------|---------------------------------------|---------------------------|
| DSS 890 241/251 MS-Lg. 375 Trennen Split cut | Obermesser 890.2641.3D 375 x 95/81/60 x 6 | 5 Langlö. | 1,05 | 014.66F236 | 233,00 |
| | Untermesser 890.2642.3B 375 x 58 x 10/6 | 5/M6 2/7 Ø | 1,06 | 014.67/102F236 | 200,00 |

MÜLLER-MARTINI (GRAPHA)



| Maschinen-Typ Type/Type/Tipo | Abmessungen in mm Size/Dimension/Tamaño | Löcher/Holes Trous/Huecos | kg | FASSCO-Id. Qualität/Quality/Calid. | €/Stück Pce./Pce./Pza. |
|---|--|------------------------------|------|---------------------------------------|---------------------------|
| DSS 890 241/251 MS-Lg. 350 Stanzen Fase 90° Punch cut Bevel 90° | Obermesser (5/32") 890.2648.2A 350 x 165/81/60 x 4 | 5 Langlöcher | 0,79 | 014.60/004F236 | * |
| | Obermesser (3/16") 890.2654.2 350 x 165/81/60 x 4,76 | 5 Langlöcher | 0,94 | 014.60/048F236 | * |
| | Obermesser 890.2649.2A 350 x 165/81/60 x 5 | 5 Langlöcher | 0,98 | 014.60/005F236 | * |
| | Obermesser 890.2650.2A 350 x 165/81/60 x 6 | 5 Langlöcher | 1,20 | 014.60/006F236 | * |
| | Obermesser (1/4") 890.2655.2A 350 x 165/81/60 x 6,35 | 5 Langlöcher | 1,27 | 014.60/064F236 | * |
| | Obermesser (5/16") 890.2651.2A 350 x 165/81/60 x 8 | 5 Langlöcher | 1,58 | 014.60/008F236 | * |
| | Obermesser (3/8") 890.2656.2 350 x 165/81/60 x 9,52 | 5 Langlöcher | 1,88 | 014.60/095F236 | * |
| | Obermesser 890.2652.2B 350 x 165/81/60 x 10 | 5 Langlöcher | 1,98 | 014.60/010F236 | * |
| | Obermesser (1/2") 350 x 165/81/60 x 12,7 | 5 Langlöcher | 2,50 | 014.60/013F236 | * |
| | Obermesser 890.2653.2B 350 x 165/81/60 x 16 | 5 Langlöcher | 3,16 | 014.60/016F236 | * |
| | Untermesser, links 890.2644.3E 350 x 58 x 6,0/5,5 | 7/M6 2/7 Ø | 0,75 | 014.61/104F236 | * |
| | Untermesser, rechts 890.2645.3E 350 x 58 x 6,0/5,5 | 7/M6 2/7 Ø | 0,75 | 014.61/105F236 | * |



MÜLLER-MARTINI (GRAPHA)

| Maschinen-Typ Type/Type/Tipo | Abmessungen in mm Size/Dimension/Tamaño | Löcher/Holes Trous/Huecos | △ kg | FASSCO-Id. Qualität/Quality/Calid. | €/Stück Pce./Pce./Pza. |
|--|---|------------------------------|----------------|---------------------------------------|---------------------------|
| DSS 890 241/251 MS-Lg. 350 Stanzen V-Fase Punch cut V-Shape | Obermesser (5/32") 890.4364.2 350 x 165/81/60 x 4 | 5 Langlöcher | 0,77 | 014.60/204F236 | * |
| | Obermesser (3/16") (890.2654.2) 350 x 165/81/60 x 4,76 | 5 Langlöcher | 0,92 | 014.60/248F236 | * |
| | Obermesser (890.2649.2) 350 x 165/81/60 x 5 | 5 Langlöcher | 0,95 | 014.60/205F236 | * |
| | Obermesser 890.4365.2 251.2430.2 350 x 165/81/60 x 6 | 5 Langlöcher | 1,12 | 014.60/206F236 | * |
| | Obermesser (1/4") (890.2655.2) 350 x 165/81/60 x 6,35 | 5 Langlöcher | 1,24 | 014.60/264F236 | * |
| | Obermesser (5/16") 890.4366.2 251.2423.2 350 x 165/81/60 x 8 | 5 Langlöcher | 1,54 | 014.60/208F236 | * |
| | Obermesser (3/8") (890.2656.2) 350 x 165/81/60 x 9,52 | 5 Langlöcher | 1,83 | 014.60/295F236 | * |
| | Obermesser 890.4367.2 350 x 165/81/60 x 10 | 5 Langlöcher | 1,94 | 014.60/210F236 | * |
| | Obermesser (1/2") 350 x 165/81/60 x 12,7 | 5 Langlöcher | 2,44 | 014.60/213F236 | * |
| Obermesser (890.2653.2) 350 x 165/81/60 x 16 | 5 Langlöcher | 3,10 | 014.60/216F236 | * | |

| Maschinen-Typ Type/Type/Tipo | Abmessungen in mm Size/Dimension/Tamaño | Löcher/Holes Trous/Huecos | △ kg | FASSCO-Id. Qualität/Quality/Calid. | €/Stück Pce./Pce./Pza. |
|--|--|------------------------------|---------|---------------------------------------|---------------------------|
| DSS 890 241/251 MS-Lg. 375 Stanzen Fase 90° Punch cut Bevel 90° | Obermesser (5/32") 890.2657.2A 375 x 165/81/60 x 4 | 5 Langlöcher | 0,86 | 014.62/004F236 | * |
| | Obermesser 890.4324.2 375 x 165/81/60 x 5 | 5 Langlöcher | 1,06 | 014.62/005F236 | * |
| | Obermesser 890.2658.2A 375 x 165/81/60 x 6 | 5 Langlöcher | 1,25 | 014.62/006F236 | * |
| | Obermesser (5/16") 890.2659.2 375x165/81/60 x 8 | 5 Langlöcher | 1,65 | 014.62/008F236 | * |
| | Obermesser 890.2660.2B 375 x 165/81/60 x 10 | 5 Langlöcher | 2,12 | 014.62/010F236 | * |
| | Untermesser, links 890.2646.3C 375 x 58 x 6,0/5,5 | 5/M6 2/7Ø | 0,79 | 014.63/102F236 | * |
| | Untermesser, rechts 890.2647.3C 375 x 58 x 6,0/5,5 | 5/M6 2/7Ø | 0,79 | 014.63/103F236 | * |

* Preis auf Anfrage / Price on request

MÜLLER-MARTINI (GRAPHA)

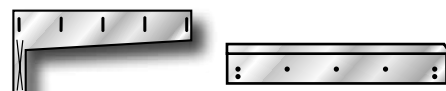

| Maschinen-Typ Type/Type/Tipo | Abmessungen in mm Size/Dimension/Tamaño | Löcher/Holes Trous/Huecos | kg | FASSCO-Id. Qualität/Quality/Calid. | €/Stück Pce./Pce./Pza. |
|---|---|------------------------------|------|---------------------------------------|---------------------------|
| DSS 890 241/251 MS-Lg. 375 Stanzen V-Fase Punch cut V-Shape | Obermesser (5/32") (890.2657.2) 375 x 165/81/60 x 4 | 5 Langlöcher | 0,83 | 014.62/204F236 | * |
| | Obermesser (890.4324.2) 375 x 165/81/60 x 5 | 5 Langlöcher | 1,03 | 014.62/205F236 | * |
| | Obermesser (890.2658.2) 251.2431.2 375 x 165/81/60 x 6 | 5 Langlöcher | 1,22 | 014.62/206F236 | * |
| | Obermesser (5/16") (890.2659.2) 375x165/81/60 x 8 | 5 Langlöcher | 1,61 | 014.62/208F236 | * |
| | Obermesser (890.2660.2) 375 x 165/81/60 x 10 | 5 Langlöcher | 2,07 | 014.62/210F236 | * |

| Maschinen-Typ Type/Type/Tipo | Abmessungen in mm Size/Dimension/Tamaño | Löcher/Holes Trous/Huecos | kg | FASSCO-Id. Qualität/Quality/Calid. | €/Stück Pce./Pce./Pza. |
|---|--|------------------------------|------|---------------------------------------|---------------------------|
| DSS 890 MS-Lg. 350 Stanzen 6mm Punch cut 6mm | Obermesser, links (Fase 25°/22°) 890.4310.2A 350 x 165/82/60 x 3 | 5 Langlöcher | 0,58 | 014.68/023F236 | * |
| | Obermesser, rechts (Fase 25°/22°) 890.4309.2A 350 x 165/82/60 x 3 | 5 Langlöcher | 0,58 | 014.68/033F236 | * |
| | Untermesser, links 890.2622.3E 350 x 58 x 10/6 | 7/M6 2/7 Ø | 0,98 | 014.69/104F236 | * |
| | Untermesser, rechts 890.4311.3B 0360.4404.3 350 x 58 x 10/6 | 7/M6 2/7 Ø | 0,98 | 014.69/105F236 | * |

| Maschinen-Typ Type/Type/Tipo | Abmessungen in mm Size/Dimension/Tamaño | Löcher/Holes Trous/Huecos | kg | FASSCO-Id. Qualität/Quality/Calid. | €/Stück Pce./Pce./Pza. |
|---|--|------------------------------|------|---------------------------------------|---------------------------|
| DSS 890 MS-Lg. 350 Stanzen 8mm Punch cut 8mm | Obermesser, links (Fase 25°/22°) 890.4306.2B 350 x 165/82/60 x 4 | 5 Langlöcher | 0,75 | 014.68/024F236 | * |
| | Obermesser, rechts (Fase 25°/22°) 890.4305.2B 350 x 165/82/60 x 4 | 5 Langlöcher | 0,75 | 014.68/034F236 | * |
| | Untermesser, links 890.2622.3E 350 x 58 x 10/6 | 7/M6 2/7 Ø | 0,98 | 014.69/104F236 | * |
| | Untermesser, rechts 890.4311.3B 360.4404.3 350 x 58 x 10/6 | 7/M6 2/7 Ø | 0,98 | 014.69/105F236 | * |



MÜLLER-MARTINI (GRAPHA)

| Maschinen-Typ Type/Type/Tipo | Abmessungen in mm Size/Dimension/Tamaño | Löcher/Holes Trous/Huecos | △±△ kg | FASSCO-Id. Qualität/Quality/Calid. | €/Stück Pce./Pce./Pza. |
|---|---|------------------------------|-----------|---------------------------------------|---------------------------|
| DSS 890 MS-Lg. 375 Stanzen 6mm Punch cut 6mm | Obermesser, links (Fase 25°/22°) 890.4330.2 375 x 165/82/60 x 3 | 5 Langlöcher | 0,62 | 014.67/023F236 | * |
| | Obermesser, rechts (Fase 25°/22°) 890.4331.2 375 x 165/82/60 x 3 | 5 Langlöcher | 0,62 | 014.67/033F236 | * |
| | Untermesser, links 890.2642.3B 375 x 58 x 10/6 | 5/M6 2/7 Ø | 1,06 | 014.67/102F236 | * |
| | Untermesser, rechts 890.4312.3A 375 x 58 x 10/6 | 5/M6 2/7 Ø | 1,06 | 014.67/103F236 | * |

| Maschinen-Typ Type/Type/Tipo | Abmessungen in mm Size/Dimension/Tamaño | Löcher/Holes Trous/Huecos | △±△ kg | FASSCO-Id. Qualität/Quality/Calid. | €/Stück Pce./Pce./Pza. |
|---|---|------------------------------|-----------|---------------------------------------|---------------------------|
| DSS 890 MS-Lg. 375 Stanzen 8mm Punch cut 8mm | Obermesser, links (Fase 25°/22°) 890.4328.2 375 x 165/82/60 x 4 | 5 Langlöcher | 0,81 | 014.67/024F236 | * |
| | Obermesser, rechts (Fase 25°/22°) 890.4329.2 375 x 165/82/60 x 4 | 5 Langlöcher | 0,81 | 014.67/034F236 | * |
| | Untermesser, links 890.2642.3B 375 x 58 x 10/6 | 5/M 6 2/7 Ø | 1,06 | 014.67/102F236 | * |
| | Untermesser, rechts 890.4312.3A 375 x 58 x 10/6 | 5/M6 2/7 Ø | 1,06 | 014.67/103F236 | * |

| Maschinen-Typ Type/Type/Tipo | Abmessungen in mm Size/Dimension/Tamaño | Löcher/Holes Trous/Huecos | △±△ kg | FASSCO-Id. Qualität/Quality/Calid. | €/Stück Pce./Pce./Pza. |
|---------------------------------------|--|------------------------------|-----------|---------------------------------------|---------------------------|
| DSS 890 TRIO-Schnitt | Obermesser, links 890.3438.3A 350 x 100/90/70 x 6 | 5 Langlöcher | 1,16 | 014.58/002F236 | * |
| | Obermesser, rechts 890.3437.3A 350 x 100/90/70 x 6 | 5 Langlöcher | 1,16 | 014.58/003F236 | * |
| | Untermesser, links 890.0541.3D 360 x 40 x 10/7 | 3 zyl.vers. 2/7 Ø | 0,76 | 014.97/102F236 | * |
| | Untermesser, rechts 890.0542.3C 360 x 40 x 10/7 | 3 zyl.vers. 2/7Ø | 0,76 | 014.97/103F236 | * |

MÜLLER-MARTINI (GRAPHA)

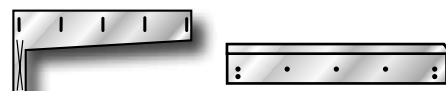

| Maschinen-Typ Type/Type/Tipo | Abmessungen in mm Size/Dimension/Tamaño | Löcher/Holes Trous/Huecos | ⚖ kg | FASSCO-Id. Qualität/Quality/Calid. | €/Stück Pce./Pce./Pza. |
|---------------------------------|--|------------------------------|---------|---------------------------------------|---------------------------|
| Stanzschnitt Punch Cut | Obermesser, links (Fase 22°) 1890.8842.2 350 x 165/81/60 x 4 | 4+5 Langlöcher | 0,72 | 076.68/042F236 | * |
| | Obermesser, rechts (Fase 22°) 1890.8843.2 350 x 165/81/60 x 4 | 4+5 Langlöcher | 0,72 | 076.68/043F236 | * |

| Maschinen-Typ Type/Type/Tipo | Abmessungen in mm Size/Dimension/Tamaño | Löcher/Holes Trous/Huecos | ⚖ kg | FASSCO-Id. Qualität/Quality/Calid. | €/Stück Pce./Pce./Pza. |
|---|--|-------------------------------------|---------|---------------------------------------|---------------------------|
| DS 360 Trennen Split cut Serie: 0360.0401 09.02 02.94 | Obermesser 0890.2623.3D 350 x 95/81/60 x 6 | 5 Langlöcher | 0,97 | 014.64F236 | 212,00 |
| | Untermesser 0360.4408.2B 360 x 32 x 15 | 4 zyl. vers. Langlöcher 2/9 Ø | 1,08 | 014.36/145F236 | 196,00 |

| Maschinen-Typ Type/Type/Tipo | Abmessungen in mm Size/Dimension/Tamaño | Löcher/Holes Trous/Huecos | ⚖ kg | FASSCO-Id. Qualität/Quality/Calid. | €/Stück Pce./Pce./Pza. |
|--|---|------------------------------|---------|---------------------------------------|---------------------------|
| DS 360 Stanzen Fase 90° Punch cut Bevel 90° Serie: 0360-0400 10.02 08.92 | Obermesser 0360.4400.2 350 x 96/81/60 x 4 | 5 Langlöcher | 0,72 | 014.30/004F236 | * |
| | Obermesser 0360.4401.2 350 x 96/81/60 x 6 | 5 Langlöcher | 1,12 | 014.30/006F236 | * |
| | Obermesser 0360.4402.2 350 x 96/81/60 x 8 | 5 Langlöcher | 1,48 | 014.30/008F236 | * |
| | Obermesser 0360 350 x 96/81/60 x 10 | 5 Langlöcher | 1,86 | 014.30/010F236 | * |
| | Untermesser, links 0890.2644.3E 350 x 58 x 6,0/5,5 | 7/M6 2/7 Ø | 0,75 | 014.61/104F236 | * |
| | Untermesser, rechts 0890.2645.3E 350 x 58 x 6,0/5,5 | 7/M6 2/7 Ø | 0,75 | 014.61/105F236 | * |



MÜLLER-MARTINI (GRAPHA)

| Maschinen-Typ Type/Type/Tipo | Abmessungen in mm Size/Dimension/Tamaño | Löcher/Holes Trous/Huecos |  kg | FASSCO-Id. Qualität/Quality/Calid. | €/Stück Pce./Pce./Pza. |
|---|--|-----------------------------------|---|---------------------------------------|---------------------------|
| DS 360/459 Stanzen V-Fase Punch cut V-Shape Serie: 0360-0401 09.02 02.94 | Obermesser 0360.4415.2 350 x 82,8/60 x 4 | 5 Langlöcher | 0,70 | 014.36/004F236 | 230,00 |
| | Obermesser 0360.4403.2 350 x 82,8/60 x 5 (3/16") | 5 Langlöcher | 0,90 | 014.36/005F236 | 230,00 |
| | Obermesser 0360.4405.2 350 x 82,8/60 x 6 | 5 Langlöcher 4/5-2,5Ø | 1,05 | 014.36/006F236 | 224,00 |
| | Obermesser (1/4") 0360 350 x 82,8/60 x 6,35 | 5 Langlöcher 4/5-2,5Ø | 1,10 | 014.36/064F236 | 242,00 |
| | Obermesser 0360.4409.2 350 x 82,8/60 x 8 | 5 Langlöcher 4/5-2,5Ø | 1,38 | 014.36/008F236 | 260,00 |
| | Obermesser (3/8") 0360 350 x 82,8/60 x 9,52 | 5 Langlöcher 4/5-2,5Ø | 1,62 | 014.36/095F236 | 300,00 |
| | Obermesser 0360.4410.2 350 x 82,8/60 x 10 | 5 Langlöcher 4/5-2,5Ø | 1,70 | 014.36/010F236 | 292,00 |
| | Obermesser 0360 350 x 82,8/60 x 12 | 5 Langlöcher 4/5-2,5Ø | 2,05 | 014.36/012F236 | 360,00 |
| | Obermesser (1/2") 0360 350 x 82,8/60 x 12,7 | 5 Langlöcher 4/5-2,5Ø | 2,15 | 014.36/013F236 | 360,00 |
| | Untermesser, links 0360.4408.2 360 x 32 x 15 | 4 zyl.vers. Langlöcher 2/9Ø | 1,08 | 014.36/145F236 | 196,00 |
| Untermesser, rechts 0360.4408.2 360 x 32 x 15 | 4 zyl.vers. Langlöcher 2/9Ø | 1,08 | 014.36/145F236 | 196,00 | |



MÜLLER-MARTINI (GRAPHA)

| Maschinen-Typ Type/Type/Tipo | Abmessungen in mm Size/Dimension/Tamaño | Löcher/Holes Trous/Huecos |  kg | FASSCO-Id. Qualität/Quality/Calid. | €/Stück Pce./Pce./Pza. |
|---|--|------------------------------------|---|---------------------------------------|---------------------------|
| DS 360 Stanzen V-Fase/mit Nase Punch cut V-Shape/ with leg | Obermesser 0360.4411.2 350 x 98,5/82,8/60 x 6 | 5 Langlöcher 4/5-2,5 Ø | 1,07 | 014.36/206F236 | * |
| | Obermesser 0360.4412.2 350 x 98,5/82,8/60 x 8 | 5 Langlöcher 4/5-2,5 Ø | 1,40 | 014.36/208F236 | * |
| | Obermesser 0360.4413.2 350 x 98,5/82,8/60 x 10 | 5 Langlöcher 4/5-2,5 Ø | 1,73 | 014.36/210F236 | * |
| | Untermesser, links 0360.4408.2 360 x 32 x 15 | 4 zyl.vers. Langlöcher 2/9 Ø | 1,08 | 014.36/145F236 | * |
| | Untermesser, rechts 0360.4408.2 360 x 32 x 15 | 4 zyl.vers. Langlöcher 2/9 Ø | 1,08 | 014.36/145F236 | * |

MÜLLER-MARTINI (GRAPHA)



| Maschinen-Typ Type/Type/Tipo | Abmessungen in mm Size/Dimension/Tamaño | Löcher/Holes Trous/Huecos | ⚖️ kg | FASSCO-Id. Qualität/Quality/Calid. | €/Stück Pce./Pce./Pza. |
|--|---|------------------------------|----------|---------------------------------------|---------------------------|
| 404 OPTIMA Schwingschneider Stanzen V-Fase/mit Nase Punch cut V-Shape/ with leg (Prototyp) | Untermesser 0404.4418.2 370 x 98,5/60 x 8/6 | 5 Langlöcher 4/5-2,5 Ø | 1,35 | 014.36/506F236 | * |
| | Untermesser 0404.4417.2 370 x 98,5/60 x 9/8 | 5 Langlöcher 4/5-2,5 Ø | 1,45 | 014.36/508F236 | * |
| | Untermesser 0404.4416.2 370 x 98,5/60 x 10 | 5 Langlöcher 4/5-2,5 Ø | 1,75 | 014.36/510F236 | * |

| Maschinen-Typ Type/Type/Tipo | Abmessungen in mm Size/Dimension/Tamaño | Löcher/Holes Trous/Huecos | ⚖️ kg | FASSCO-Id. Qualität/Quality/Calid. | €/Stück Pce./Pce./Pza. |
|---|--|------------------------------|----------|---------------------------------------|---------------------------|
| 404 OPTIMA Schwingschnitt Swing cut Stanzen V-Fase/mit Nase Punch cut V-Shape/ with leg (Prototyp) | Untermesser 0135.2756.2 370 x 83,2/57 x 8/6 | 5 Langlöcher 4/5-2,5 Ø | 1,15 | 014.04/506F236 | * |
| | Untermesser 0135.2755.2 370 x 83,8/57 x 9/8 | 5 Langlöcher 4/5-2,5 Ø | 1,44 | 014.04/508F236 | * |
| | Untermesser 0135.2754.2 370 x 84,6/57 x 10 | 5 Langlöcher 4/5-2,5 Ø | 1,62 | 014.04/510F236 | * |
| | Obermesser, links 0404.4419.2 380 x 32 x 15 | 5/M8 2/9 Ø | 1,30 | 014.36/156F236 | * |
| | Obermesser, rechts 0404.4419.2 380 x 32 x 15 | 5/M8 2/9 Ø | 1,30 | 014.36/156F236 | * |

| Maschinen-Typ Type/Type/Tipo | Abmessungen in mm Size/Dimension/Tamaño | Löcher/Holes Trous/Huecos | ⚖️ kg | FASSCO-Id. Qualität/Quality/Calid. | €/Stück Pce./Pce./Pza. |
|---|--|------------------------------|----------|---------------------------------------|---------------------------|
| 404 OPTIMA Schwingschnitt Swing cut Stanzen V-Fase/mit Nase Punch cut V-Shape/ with leg | Untermesser 0404.4428.2 370 x 80,1/57 x 8/6 | 5 Langlöcher 4/5-2,5 Ø | 1,15 | 014.04/606F236 | * |
| | Untermesser 0404.4427.2 370 x 80,7/57 x 9/8 | 5 Langlöcher 4/5-2,5 Ø | 1,44 | 014.04/608F236 | * |
| | Untermesser 0404.4426.2 370 x 81,3/57 x 10 | 5 Langlöcher 4/5-2,5 Ø | 1,62 | 014.04/610F236 | * |
| | Obermesser, links 0404.4419.2 380 x 32 x 15 | 5/M8 2/9 Ø | 1,30 | 014.36/156F236 | * |
| | Obermesser, rechts 0404.4419.2 380 x 32 x 15 | 5/M8 2/9 Ø | 1,30 | 014.36/156F236 | * |



MÜLLER-MARTINI (GRAPHA, VIRGINIA/USA)

| Maschinen-Typ Type/Type/Tipo | Abmessungen in mm Size/Dimension/Tamaño | Löcher/Holes Trous/Huecos | ⚖️ kg | FASSCO-Id. Qualität/Quality/Calid. | €/Stück Pce./Pce./Pza. |
|--|---|------------------------------|----------|---------------------------------------|---------------------------|
| 1542 Trennschnitt Split cut | Obermesser, links 1542.1450.3 340 x 97/78/61,5 x 8 | 18/M6 | 1,25 | 064.64/002F236 | * |
| | Obermesser, rechts 1542.1080.3 340 x 97/78/61,5 x 8 | 18/M6 | 1,25 | 064.64/003F236 | * |
| | Untermesser, links 1542.1452.3 340 x 50 x 10/8 | 12/M6 | 1,10 | 064.64/102F236 | * |
| | Untermesser, rechts 1542.1107.3 340 x 50 x 10/8 | 12/M6 | 1,10 | 064.64/103F236 | * |

| Maschinen-Typ Type/Type/Tipo | Abmessungen in mm Size/Dimension/Tamaño | Löcher/Holes Trous/Huecos | ⚖️ kg | FASSCO-Id. Qualität/Quality/Calid. | €/Stück Pce./Pce./Pza. |
|--|--|------------------------------|----------|---------------------------------------|---------------------------|
| 1542 Stanzen Fase 90° Punch cut Bevel 90° | Obermesser 1542.1335.3 340 x 92/78/61,5 x 4 | 12/M6 | 0,70 | 064.61/004F236 | * |
| | Obermesser 1542.1336.3 340 x 92/78/61,5 x 5 | 12/M6 | 0,90 | 064.61/005F236 | * |
| | Obermesser 1542.1081.3 340 x 92/78/61,5 x 6,35 | 12/M6 | 1,13 | 064.61/064F236 | * |
| | Obermesser 1542.1337.3 340 x 92/78/61,5 x 8 | 12/M6 | 1,45 | 064.61/008F236 | * |
| | Obermesser 1542.1338.3 340 x 92/78/61,5 x 10 | 12/M6 | 1,80 | 064.61/010F236 | * |
| | Untermesser, links 1542.1108.3 340 x 49 x 8/7 | 12/M6 | 0,75 | 064.61/102F236 | * |
| | Untermesser, rechts 1542.1286.3 340 x 49 x 8/7 | 12/M6 | 0,75 | 064.61/103F236 | * |

| Maschinen-Typ Type/Type/Tipo | Abmessungen in mm Size/Dimension/Tamaño | Löcher/Holes Trous/Huecos | ⚖️ kg | FASSCO-Id. Qualität/Quality/Calid. | €/Stück Pce./Pce./Pza. |
|--|--|------------------------------|----------|---------------------------------------|---------------------------|
| 1542 Stanzen V-Fase Punch cut V-Shape | Obermesser (1/4") 1542.1712.2A 340 x 83,94/61,5 x 6,35 | 12/6,4 Ø 4/5-2,5 Ø | 1,13 | 064.60/264F236 | * |
| | Obermesser 1542.1713.2A 340 x 83,94/61,5 x 8 | 12/6,4 Ø 4/5-2,5 Ø | 1,45 | 064.60/208F236 | * |
| | Obermesser 1542.1714.2A 340 x 83,94/61,5 x 10 | 12/6,4 Ø 4/5-2,5 Ø | 1,80 | 064.60/210F236 | * |
| | Untermesser, links 1542.1726.3A 340 x 31 x 15,5 | 5 zyl.vers. Langlöcher | 1,03 | 064.60/145F236 | * |
| | Untermesser, rechts 1542.1726.3A 340 x 31 x 15,5 | 5 zyl.vers. Langlöcher | 1,03 | 064.60/145F236 | * |

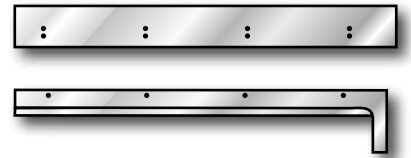

MÜLLER-MARTINI (GAZEMESSER)

| Maschinen-Typ Type/Type/Tipo | Abmessungen in mm Size/Dimension/Tamaño | Löcher/Holes Trous/Huecos | ⚖ kg | FASSCO-Id. Qualität/Quality/Calid. | €/Stück Pce./Pce./Pza. |
|--|--|------------------------------|---------|---------------------------------------|---------------------------|
| Gazestation 3000 | Obermesser 3000.2756.2A 590 x 170/35/24 x 8 | 4/M6 | 1,34 | 014.70F236 | * |
| | Untermesser 3000.2755.3 599 x 65 x 5 | 2/M6 | 1,46 | 014.71F236 | * |
| Gazestation 3002 /NB 4 | Obermesser 3002.2035.3E 3002.3673.3 570 x 95/45 x 8/4 | 4/M6 | 1,50 | 014.72/001F236 | * |
| | Untermesser 3002.2034.3B 580 x 50 x 6 | 8/M6 | 1,33 | 014.73F236 | * |
| Gazestation 3006 | Obermesser 3006.2041.3 524 x 95/45 x 8 | 6/M6 | 1,48 | 014.76F236 | * |
| | Untermesser 3006.2079.3 497 x 50 x 10/4 | 4 zyl.vers. Langlöcher | 1,46 | 014.77F236 | * |
| Gazestation 3009 | Obermesser (3009.2836.3A) 545 x 85/45 x 8 | 4/M6 | 1,54 | 014.80/001F236 | * |
| | Untermesser (3009.4662.3) 544 x 50 x 10/4 | 4/M6 | 1,54 | 014.80/101F236 | * |
| Gazestation 3010 verwendbar/ usable f. 3009 | Obermesser (3010.3852.3A) 550 x 85/45 x 8 | 4/M6 | 1,55 | 014.80/011F236 | * |
| | Untermesser (3010.3851.3A) 554 x 50 x 10/4 | 4/M6 | 1,55 | 014.80/111F236 | * |
| Gazestation 3049 AK/BBA | Obermesser 3049.1102.2 (BBA-2-10102a) 550 x 30 x 23 | 2 zyl.vers Langlöcher | 1,60 | 014.78F236 | * |
| | Untermesser 3049.1101.2 (BBA-2-10101) 460 x 59/50 x 4,4 | 5 Langlöcher | 0,75 | 014.79F236 | * |
| Gazestation 3061 EB | Obermesser 3061.0840.2 (EB2-840) 450 x 88/68/51 x 5 | 4/M6 | 1,10 | 014.49/001F236 | * |
| | Untermesser 3061.0841.2 (EB2-841) 460 x 40 x 4 | 2/M5 | 0,56 | 014.49/101F236 | * |
| RB 5 Rotorbinder | Obermesser 896.1590.3C 460 x 24/12 x 8 | 4/M5 | 0,33 | 014.74F236 | * |
| | Untermesser 896.1597.3B 460 x 75/65 x 6 | 2 Langlöcher | 1,31 | 014.75F236 | * |



NAGAI

(Exporter: UCHIDA YOKO CO.)

| Maschinen-Typ Type/Type/Tipo | Abmessungen in mm Size/Dimension/Tamaño | Löcher/Holes Trous/Huecos | △ kg | FASSCO-Id. Qualität/Quality/Calid. | €/Stück Pce./Pce./Pza. |
|---------------------------------|--|------------------------------|---------|---------------------------------------|---------------------------|
| NC 61 SH | 750 x 110 x 7,95 | 14/M10 | 4,50 | 107.08F220 | * |
| | | | | 107.08F3000 | * |
| NC 77 | 950 x 140 x 11,1 | 18/M10 | 10,20 | 107.09F220 | * |
| | | | | 107.09F3000 | * |
| NC 92 | 1200 x 140 x 11,11 | 8 1/2"W | 12,90 | 107.01F220 | * |
| | | | | 107.01F3000 | * |
| NCW 100 HH | 1200 x 140 x 11,11 | 20/M12 | 12,80 | 107.02F220 | * |
| | | | | 107.02F3000 | * |
| NCW 102 HH | 1200 x 140 x 12,7 | 24/M12 | 14,80 | 107.03F220 | * |
| | | | | 107.03F3000 | * |
| NCW 115 HH | 1388 x 150 x 13,7 | 30/M12 | 19,80 | 107.06F220 | * |
| | | | | 107.06F3000 | * |
| NCW 116 HH | 1390 x 150 x 13,7 | 30/M12 | 19,85 | 107.07F220 | * |
| | | | | 107.07F3000 | * |
| NCW 132 HH | 1530 x 150 x 13,7 | 32/M12 | 21,80 | 107.04F220 | * |
| | | | | 107.04F3000 | * |
| NCW 132 HH | 1560 x 150 x 13,7 | 32/M12 | 22,25 | 107.05F220 | * |
| | | | | 107.05F3000 | * |



NAGEL (FOLDNAK)

| Maschinen-Typ Type/Type/Tipo | Abmessungen in mm Size/Dimension/Tamaño | Löcher/Holes Trous/Huecos | △ kg | FASSCO-Id. Qualität/Quality/Calid. | €/Stück Pce./Pce./Pza. |
|---------------------------------|--|------------------------------|---------|---------------------------------------|---------------------------|
| Foldnak 100 | Obermesser (295 3916) 350 x 75/70/55 x 6 | 5 Langlöcher 2/M6 | 0,88 | 094.90/001F236 | * |
| | Untermesser (295 3997) 358 x 20 x 12 | 5 zyl.vers. Langlöcher | 0,62 | 094.90/101F236 | * |

| Maschinen-Typ Type/Type/Tipo | Abmessungen in mm Size/Dimension/Tamaño | Löcher/Holes Trous/Huecos | △ kg | FASSCO-Id. Qualität/Quality/Calid. | €/Stück Pce./Pce./Pza. |
|---------------------------------|---|------------------------------|---------|---------------------------------------|---------------------------|
| Trimmer | Obermesser (2710105) 392 x 77/72/55 x 6 | 5 Langlöcher 2/M6 | 1,05 | 094.91/001F236 | * |
| | Untermesser (2710103) 400 x 20 x 12 | 5 zyl.vers. Langlöcher | 0,69 | 094.91/101F236 | * |

NATIONAL

| Maschinen-Typ Type/Type/Tipo | Abmessungen in mm Size/Dimension/Tamaño | Löcher/Holes Trous/Huecos | ⚖️ kg | FASSCO-Id. Qualität/Quality/Calid. | €/Stück Pce./Pce./Pza. |
|---------------------------------|--|------------------------------|----------|---------------------------------------|---------------------------|
| 36" | 1117,6 x 127 x 12,45 44x5x.49" | 24 1/2"-12 | 12,00 | 112.01F220 | * |
| | | | | 112.01F3000 | * |
| 44" | 1320,8 x 127 x 12,45 52x5x.49" | 27 1/2"-12 | 14,40 | 112.03F220 | * |
| | | | | 112.03F3000 | * |

NISHIKAWA



| Maschinen-Typ Type/Type/Tipo | Abmessungen in mm Size/Dimension/Tamaño | Löcher/Holes Trous/Huecos | ⚖️ kg | FASSCO-Id. Qualität/Quality/Calid. | €/Stück Pce./Pce./Pza. |
|---------------------------------|--|------------------------------|----------|---------------------------------------|---------------------------|
| NHM-122 NHN-1220 | 1450 x 150 x 13,7 | 32/M12 | 20,70 | 080.01F220 | * |
| | | | | 080.01F3000 | * |

OBSCURE

| Maschinen-Typ Type/Type/Tipo | Abmessungen in mm Size/Dimension/Tamaño | Löcher/Holes Trous/Huecos | ⚖️ kg | FASSCO-Id. Qualität/Quality/Calid. | €/Stück Pce./Pce./Pza. |
|---------------------------------|--|------------------------------|----------|---------------------------------------|---------------------------|
| Linea Maxima | Obermesser 381 x 98/78/49 x 6,5 | 5 Langlö. | 1,10 | 140.90/001F236 | * |
| | Untermesser 390 x 28 x 14 | 5 zyl.vers. Langlöcher | 0,80 | 140.90/101F236 | * |

Für diese Typen ist eine Zeichnung erforderlich.
For these types a drawing is required.



| Maschinen-Typ Type/Type/Tipo | Abmessungen in mm Size/Dimension/Tamaño | Löcher/Holes Trous/Huecos | △ kg | FASSCO-Id. Qualität/Quality/Calid. | €/Stück Pce./Pce./Pza. |
|---|--|------------------------------|---------|---------------------------------------|---------------------------|
| T/C 73/76 TH 76 | 965 x 120 x 10 (76-21) | 30/M10 | 8,00 | 020.01F220 | * |
| | | | | 020.01F3000 | * |
| T/C 82 | 1005 x 101,41 x 8 | 14/M10 | 5,60 | 020.04F220 | * |
| | | | | 020.04F3000 | * |
| TNX 1051f | 1040 x 130 x 11 | 18/M10 | 10,30 | 020.25F220 | * |
| | | | | 020.25F3000 | * |
| TOE 84 | 1053 x 118,76 x 10 | 18/M8 | 8,60 | 020.07F220 | * |
| | | | | 020.07F3000 | * |
| TOE 83 | 1060 x 142,12 x 12 (83-21) | 22/M8 | 12,45 | 020.05F220 | * |
| | | | | 020.05F3000 | * |
| T/N/X 90 T/N/E 90 TNH 91, TOE92 | 1155 x 118,76 x 10 (90-21) | 22/M8 | 9,45 | 020.02F220 | * |
| | | | | 020.02F3000 | * |
| T/H 103, TA103 TOE 103, TA105 TOE 105, TH105 TOE 108 | 1215 x 118,76 x 10 (103-21) | 22/M8 | 9,95 | 020.06F220 | * |
| | | | | 020.06F3000 | * |
| TA105 | 1220 x 118,76 x 10 | 24/M8 | 9,95 | 020.26F220 | * |
| | | | | 020.26F3000 | * |
| T/NH 105 | 1235 x 119,1 x 12 | 24/M8 | 12,20 | 020.03F220 | * |
| | | | | 020.03F3000 | * |
| TOE 110/112 | 1320 x 142,12 x 12 (110-21) | 22/M10 | 15,55 | 020.09F220 | * |
| | | | | 020.09F3000 | * |
| TOE 107 | 1326 x 142,12 x 12 | 26/M8 | 15,50 | 020.24F220 | * |
| | | | | 020.24F3000 | * |
| T/N/H/E 117 TOE 118/120 | 1426 x 142,12 x 12 (117-21) | 28/M8 | 16,85 | 020.11F220 | * |
| | | | | 020.11F3000 | * |
| TOE 131/135 Monoblocco | 1540 x 142,12 x 12 (131-21) | 28/M10 | 18,20 | 020.12F220 | * |
| | | | | 020.12F3000 | * |
| TOE 148 | 1730 x 142,12 x 12 | 45/M10 | 20,30 | 020.14F220 | * |
| | | | | 020.14F3000 | * |
| TOE 148 TOE 155 | 1790 x 142,12 x 12 (S 2-21) | 32/M10 | 21,10 | 020.15F220 | * |
| | | | | 020.15F3000 | * |
| T/O 150 T/O 154 | 1790 x 203,17 x 18 | 51/M12 | 45,40 | 020.23F220 | * |
| | | | | 020.23F3000 | * |
| T/O/E 170/175 | 1950 x 183,17 x 18 (170-21) | 36/M12 | 44,70 | 020.16F220 | * |
| | | | | 020.16F3000 | * |
| T/O 200 | 2250 x 183,17 x 18 | 42/M12 | 51,50 | 020.17F220 | * |
| | | | | 020.17F3000 | * |
| TOE 220 | 2450 x 183,17 x 18 (220-21) | 44/M12 | 56,10 | 020.19F220 | * |
| | | | | 020.19F3000 | * |
| TOE 260 | 2850 x 183,17 x 18 (260-21) | 52/M12 | 65,30 | 020.21F220 | * |
| | | | | 020.21F3000 | * |

OSAKO

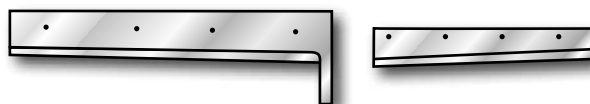

| Maschinen-Typ Type/Type/Tipo | Abmessungen in mm Size/Dimension/Tamaño | Löcher/Holes Trous/Huecos | kg | FASSCO-Id. Qualität/Quality/Calid. | €/Stück Pce./Pce./Pza. |
|---------------------------------|---|------------------------------|------|---------------------------------------|---------------------------|
| 368 OT-3A | Vordermesser, oben 3-TY-2029-2 520 x 145/80/65 x 10 | 4/M8 | 2,55 | 073.90/001F236 | 285,00 |
| | Seitenmesser, oben links 3-TY-2005 355 x 65/55 x 10 | 4/M8 | 1,33 | 073.90/002F236 | 150,00 |
| | Seitenmesser, oben rechts 3-TY-2005 355 x 65/55 x 10 | 4/M8 | 1,33 | 073.90/003F236 | 150,00 |
| | Vordermesser, unten 3-TY-2030 520 x 40 x 15/10 | 5 vers.Lö. | 1,70 | 073.90/101F236 | 155,00 |
| | Seitenmesser, unten links 3-TY-2006 360 x 40 x 15/10 | 3 vers.Lö. | 1,15 | 073.90/102F236 | 121,00 |
| | Seitenmesser, unten rechts 3-TY-2006 360 x 40 x 15/10 | 3 vers.Lö. | 1,15 | 073.90/103F236 | 121,00 |
| €/Satz/Set/Jeu/Juego | | | | | |
| 368 OT-3A | Satz Obermesser Set Upper knives | = 3 Messer = 3 knives | 5,21 | 073.90/300F236 | 585,00 |
| | Satz Untermesser Set Bottom knives | = 3 Messer = 3 knives | 4,00 | 073.90/303F236 | 397,00 |

OSAKO

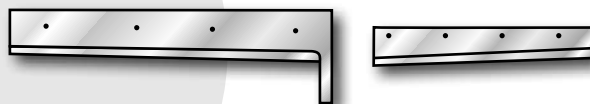

| Maschinen-Typ Type/Type/Tipo | Abmessungen in mm Size/Dimension/Tamaño | Löcher/Holes Trous/Huecos | kg | FASSCO-Id. Qualität/Quality/Calid. | €/Stück Pce./Pce./Pza. |
|---|---|------------------------------|------|---------------------------------------|---------------------------|
| 368 OT-3A Schwingschnitt Swing Cut | Vordermesser, oben 3-TY-2029-2 520 x 145/80/65 x 10 | 4/M8 | 2,55 | 073.90/001F236 | 285,00 |
| | Seitenmesser, oben links 345 x 85/65/55 x 10 | 4/M8 | 1,35 | 073.91/002F236 | 205,00 |
| | Seitenmesser, oben rechts 345 x 85/65/55 x 10 | 4/M8 | 1,35 | 073.91/003F236 | 205,00 |
| | Vordermesser, unten 3-TY-2030 520 x 40 x 15/10 | 5 vers.Lö. | 1,70 | 073.90/101F236 | 155,00 |
| | Seitenmesser, unten links 3-TY-2006 360 x 40 x 15/10 | 3 vers.Lö. | 1,15 | 073.90/102F236 | 121,00 |
| | Seitenmesser, unten rechts 3-TY-2006 360 x 40 x 15/10 | 3 vers. Lö. | 1,15 | 073.90/103F236 | 121,00 |
| €/Satz/Set/Jeu/Juego | | | | | |
| 368 OT-3A Schwingschnitt Swing Cut | Satz Obermesser Set Upper knives | = 3 Messer = 3 knives | 5,25 | 073.91/300F236 | 695,00 |
| | Satz Untermesser Set Bottom knives | = 3 Messer = 3 knives | 4,00 | 073.90/303F236 | 397,00 |

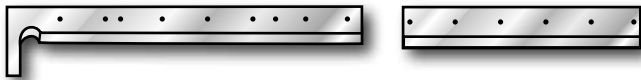

OSAKO

| Maschinen-Typ Type/Type/Tipo | Abmessungen in mm Size/Dimension/Tamaño | Löcher/Holes Trous/Huecos | ⚖ kg | FASSCO-Id. Qualität/Quality/Calid. | €/Stück Pce./Pce./Pza. |
|---------------------------------|---|------------------------------|---------|---------------------------------------|---------------------------|
| 175 OST-Trimmer | Vordermesser, oben 400 x 85/65 x 10 | 4/M8 | 1,98 | 073.92/001F236 | * |
| | Seitenmesser, oben links 330 x 85/65 x 10 | 4/M8 | 1,61 | 073.92/002F236 | * |
| | Seitenmesser, oben rechts 330 x 85/65 x 10 | 4/M8 | 1,61 | 073.92/003F236 | * |
| | Vordermesser, unten 400 x 40 x 15/10 | 4 vers.Lö. | 1,31 | 073.92/101F236 | * |
| | Seitenmesser, unten links 330 x 65 x 10 | 4/M8 | 1,63 | 073.92/123F236 | * |
| | Seitenmesser, unten rechts 330 x 65 x 10 | 4/M8 | 1,63 | 073.92/123F236 | * |
| €/Satz/Set/Jeu/Juego | | | | | |
| 175 OST-Trimmer | Satz Obermesser Set Upper knives | = 3 Messer = 3 knives | 5,20 | 073.92/300F236 | * |
| | Satz Untermesser Set Bottom knives | = 3 Messer = 3 knives | 4,57 | 073.92/303F236 | * |

| Maschinen-Typ Type/Type/Tipo | Abmessungen in mm Size/Dimension/Tamaño | Löcher/Holes Trous/Huecos | ⚖ kg | FASSCO-Id. Qualität/Quality/Calid. | €/Stück Pce./Pce./Pza. |
|---------------------------------|--|------------------------------|---------|---------------------------------------|---------------------------|
| 378 OT-325 | Vordermesser, oben 3-OT-60755 530 x 99/69 x 8 | 7/M6 2/7 Ø | 1,96 | 073.93/001F236 | * |
| | Seitenmesser, oben links 3-OT-60713 365 x 60 x 8 | 6/M6 | 1,10 | 073.93/023F236 | * |
| | Seitenmesser, oben rechts 3-OT-60713 365 x 60 x 8 | 6/M6 | 1,10 | 073.93/023F236 | * |
| | Vordermesser, unten 3-OT-60754 540 x 40 x 15/10 | 5 vers.Lö. 1/9 Ø | 1,77 | 073.93/101F236 | * |
| | Seitenmesser, unten links 3-OT-60710 400 x 40 x 15/10 | 5 vers.Lö. | 1,26 | 073.93/123F236 | * |
| | Seitenmesser, unten rechts 3-OT-60710 400 x 40 x 15/10 | 5 vers.Lö. | 1,26 | 073.93/123F236 | * |
| €/Satz/Set/Jeu/Juego | | | | | |
| 378 OT-325 | Satz Obermesser Set Upper knives | = 3 Messer = 3 knives | 4,16 | 073.93/300F236 | * |
| | Satz Untermesser Set Bottom knives | = 3 Messer = 3 knives | 4,29 | 073.93/303F236 | * |

**N
O
P
R**

OSAKO

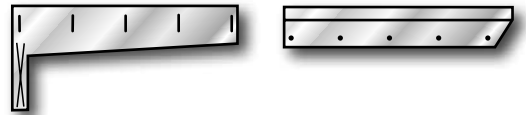

| Maschinen-Typ Type/Type/Tipo | Abmessungen in mm Size/Dimension/Tamaño | Löcher/Holes Trous/Huecos | △ kg | FASSCO-Id. Qualität/Quality/Calid. | €/Stück Pce./Pce./Pza. |
|---------------------------------|---|------------------------------|---------|---------------------------------------|---------------------------|
| 378 altern.Modell | Untermesser 540 x 40 x 18/13 | 5 vers.Lö. 1/9 Ø | 2,25 | 073.93/111F236 | * |
| | Untermesser, links 400 x 40 x 18/13 | 5 vers.Lö. | 1,61 | 073.93/145F236 | * |
| | Untermesser, rechts 400 x 40 x 18/13 | 5 vers.Lö. | 1,61 | 073.93/145F236 | * |
| | Untermesser, links 40131 370 x 25 x 15 | 5 zyl.vers. Langlöcher | 0,97 | 073.94/123F236 | * |
| | Untermesser, rechts 40131 370 x 25 x 15 | 5 zyl.vers. Langlöcher | 0,97 | 073.94/123F236 | * |

| Maschinen-Typ Type/Type/Tipo | Abmessungen in mm Size/Dimension/Tamaño | Löcher/Holes Trous/Huecos | △ kg | FASSCO-Id. Qualität/Quality/Calid. | €/Stück Pce./Pce./Pza. |
|---------------------------------|---|------------------------------------|---------|---------------------------------------|---------------------------|
| OT 2000 | Vordermesser, oben 550 x 95/65 x 10 | 8/M6 2/9 Ø | 2,50 | 073.95/001F236 | 275,00 |
| | Seitenmesser, oben links 320 x 65 x 10 | 6/M6 | 1,45 | 073.95/023F236 | 115,00 |
| | Seitenmesser, oben rechts 320 x 65 x 10 | 6/M6 | 1,45 | 073.95/023F236 | 115,00 |
| | Vordermesser, unten 550 x 40 x 15 | 5 zyl.vers. Langlöcher | 2,05 | 073.95/101F236 | 227,00 |
| | Seitenmesser, unten links 380 x 32 x 14,75/13,7 | 5 zyl.vers. Langlöcher 2/9 Ø | 1,05 | 073.95/145F236 | 185,00 |
| | Seitenmesser, unten rechts 380 x 32 x 14,75/13,7 | 5 zyl.vers. Langlöcher 2/9 Ø | 1,05 | 073.95/145F236 | 185,00 |
| €/Satz/Set/Jeu/Juego | | | | | |
| OT 2000 | Satz Obermesser Set Upper knives | = 3 Messer = 3 knives | 5,40 | 073.95/300F236 | 505,00 |
| | Satz Untermesser Set Bottom knives | = 3 Messer = 3 knives | 4,15 | 073.95/303F236 | 597,00 |

| Maschinen-Typ Type/Type/Tipo | Abmessungen in mm Size/Dimension/Tamaño | Löcher/Holes Trous/Huecos | △ kg | FASSCO-Id. Qualität/Quality/Calid. | €/Stück Pce./Pce./Pza. |
|--|---|------------------------------|---------|---------------------------------------|---------------------------|
| 368/378 OT-3A Trennen Split cut | Obermesser 3-TK-2009 350 x 96/82/60 x 6 | 5 Langlö. | 1,03 | 073.64F236 | * |
| | Untermesser 3-TK-2010 350 x 58 x 10/6 | 5/M6 | 1,06 | 073.65F236 | * |

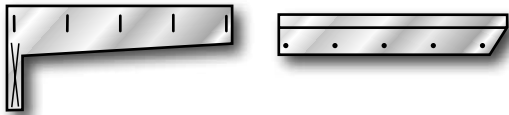

OSAKO

| Maschinen-Typ Type/Type/Tipo | Abmessungen in mm Size/Dimension/Tamaño | Löcher/Holes Trous/Huecos | ⚖ kg | FASSCO-Id. Qualität/Quality/Calid. | €/Stück Pce./Pce./Pza. |
|---|--|------------------------------|---------|---------------------------------------|---------------------------|
| 368/OT-3A Stanzen Fase 90° Punch Cut Bevel 90° | Obermesser (5/32") 3-TK-2005 350 x 165/82/60 x 4 | 5 Langlöcher | 0,79 | 073.60/004F236 | * |
| | Obermesser (3/16") 3-TK-2005 350 x 165/82/60 x 5 | 5 Langlöcher | 0,98 | 073.60/005F236 | * |
| | Obermesser (1/4") 3-TK-2005 350 x 165/82/60 x 6 | 5 Langlöcher | 1,20 | 073.60/006F236 | * |
| | Obermesser (5/16") 3-TK-2005 350 x 165/82/60 x 8 | 5 Langlöcher | 1,58 | 073.60/008F236 | * |
| | Obermesser (3/8") 3-TK-2005 350 x 165/82/60 x 10 | 5 Langlöcher | 1,98 | 073.60/010F236 | * |
| | Untermesser, links 3-TK-2008 350 x 58 x 6,0/5,7 | 5/M6 | 0,76 | 073.61/102F236 | * |
| | Untermesser, rechts 3-TK-2008 350 x 58 x 6,0/5,7 | 5/M6 | 0,76 | 073.61/103F236 | * |

| Maschinen-Typ Type/Type/Tipo | Abmessungen in mm Size/Dimension/Tamaño | Löcher/Holes Trous/Huecos | ⚖ kg | FASSCO-Id. Qualität/Quality/Calid. | €/Stück Pce./Pce./Pza. |
|---|--|------------------------------|---------|---------------------------------------|---------------------------|
| 368/OT-3A Stanzen V-Fase Punch Cut V-Shape | Obermesser (5/32") (3-TK-2005) 350 x 165/82/60 x 4 | 5 Langlöcher | 0,77 | 073.60/204F236 | * |
| | Obermesser (3/16") (3-TK-2005) 350 x 165/82/60 x 5 | 5 Langlöcher | 0,95 | 073.60/205F236 | * |
| | Obermesser (1/4") (3-TK-2005) 350 x 165/82/60 x 6 | 5 Langlöcher | 1,12 | 073.60/206F236 | * |
| | Obermesser (5/16") (3-TK-2005) 350 x 165/82/60 x 8 | 5 Langlöcher | 1,54 | 073.60/208F236 | * |
| | Obermesser (3/8") (3-TK-2005) 350 x 165/82/60 x 10 | 5 Langlöcher | 1,94 | 073.60/210F236 | * |

OSAKO

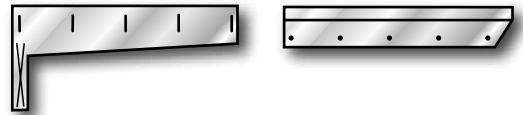

| Maschinen-Typ Type/Type/Tipo | Abmessungen in mm Size/Dimension/Tamaño | Löcher/Holes Trous/Huecos | △ kg | FASSCO-Id. Qualität/Quality/Calid. | €/Stück Pce./Pce./Pza. |
|---|--|------------------------------|---------|---------------------------------------|---------------------------|
| 378 Stanzen Fase 90° Punch Cut Bevel 90° | Obermesser (5/32") 350 x 115/83/63 x 4 | 5 Langlöcher | 0,76 | 073.63/004F236 | * |
| | Obermesser (3/16") 350 x 115/83/63 x 5 | 5 Langlöcher | 0,94 | 073.63/005F236 | * |
| | Obermesser (1/4") 350 x 115/83/63 x 6 | 5 Langlöcher | 1,15 | 073.63/006F236 | * |
| | Obermesser (5/16") 350 x 115/83/63 x 8 | 5 Langlöcher | 1,50 | 073.63/008F236 | * |
| | Obermesser (3/8") 350 x 115/83/63 x 10 | 5 Langlöcher | 1,90 | 073.63/010F236 | * |
| | Untermesser, links 3-TK-2008 350 x 58 x 6,0/5,7 | 5/M6 | 0,76 | 073.61/102F236 | * |
| | Untermesser, rechts 3-TK-2008 350 x 58 x 6,0/5,7 | 5/M6 | 0,76 | 073.61/103F236 | * |

| Maschinen-Typ Type/Type/Tipo | Abmessungen in mm Size/Dimension/Tamaño | Löcher/Holes Trous/Huecos | △ kg | FASSCO-Id. Qualität/Quality/Calid. | €/Stück Pce./Pce./Pza. |
|---|--|------------------------------|---------|---------------------------------------|---------------------------|
| 378 Stanzen V-Fase Punch Cut V-Shape | Obermesser (5/32") 350 x 115/83/63 x 4 | 5 Langlöcher | 0,74 | 073.63/204F236 | * |
| | Obermesser (3/16") 350 x 115/83/63 x 5 | 5 Langlöcher | 0,91 | 073.63/205F236 | * |
| | Obermesser (1/4") 350 x 115/83/63 x 6 | 5 Langlöcher | 1,10 | 073.63/206F236 | * |
| | Obermesser (5/16") 350 x 115/83/63 x 8 | 5 Langlöcher | 1,44 | 073.63/208F236 | * |
| | Obermesser (3/8") 350 x 115/83/63 x 10 | 5 Langlöcher | 1,83 | 073.63/210F236 | * |

OSAKO



| Maschinen-Typ Type/Type/Tipo | Abmessungen in mm Size/Dimension/Tamaño | Löcher/Holes Trous/Huecos | △ kg | FASSCO-Id. Qualität/Quality/Calid. | €/Stück Pce./Pce./Pza. |
|---|--|------------------------------|---------|---------------------------------------|---------------------------|
| Stanzen Sondermodell V-Fase Punch Cut special type V-Shape | Obermesser (5/32") 350 x 83/60 x 18/4 | 5 Langlöcher | 2,15 | 073.67/204F236 | * |
| | Obermesser (3/16") 350 x 83/60 x 18/5 | 5 Langlöcher | 2,25 | 073.67/205F236 | * |
| | Obermesser (1/4") 350 x 83/60 x 18/6 | 5 Langlöcher | 2,35 | 073.67/206F236 | * |
| | Obermesser (5/16") 350 x 83/60 x 18/8 | 5 Langlöcher | 2,50 | 073.67/208F236 | * |
| | Obermesser (3/8") 350 x 83/60 x 18/10 | 5 Langlöcher | 2,65 | 073.67/210F236 | * |

*Preis auf Anfrage / *Price on request

| Maschinen-Typ Type/Type/Tipo | Abmessungen in mm Size/Dimension/Tamaño | Löcher/Holes Trous/Huecos | △ kg | FASSCO-Id. Qualität/Quality/Calid. | €/Stück Pce./Pce./Pza. |
|---|--|------------------------------|---------|---------------------------------------|---------------------------|
| 378 Stanzen V-Fase Punch Cut V-Shape | Obermesser 350 x 82,8/60 x 6 | 5 Langlöcher | 1,05 | 073.62/006F236 | * |



PARAGON

| Maschinen-Typ Type/Type/Tipo | Abmessungen in mm Size/Dimension/Tamaño | Löcher/Holes Trous/Huecos | kg | FASSCO-Id. Qualität/Quality/Calid. | €/Stück Pce./Pce./Pza. |
|---------------------------------|--|------------------------------|------|---------------------------------------|---------------------------|
| | 647,7 x 101.6 x 7.74 25.50"x4.00"x.305" | 8 3/8"-16NC | 3,50 | 128.01F220 | * |
| | | | | 128.01F3000 | * |



PEERLESS GEM

| Maschinen-Typ Type/Type/Tipo | Abmessungen in mm Size/Dimension/Tamaño | Löcher/Holes Trous/Huecos | kg | FASSCO-Id. Qualität/Quality/Calid. | €/Stück Pce./Pce./Pza. |
|---------------------------------|--|--------------------------------|-------|---------------------------------------|---------------------------|
| 23" | 660,4 x 114,3 x 9,52 26"x4.5"x.375" | 8 1/2"-12 (3/8"-5/8") | 5,00 | 057.01F220 | * |
| | | | | 057.01F3000 | * |
| 23" | 660,4 x 114,3 x 9,52 26"x4.5"x.375" | 8 1/2"-13 NC (1/2"-5/8") | 5,00 | 057.03F220 | * |
| | | | | 057.03F3000 | * |
| 25" | 723,9 x 114,3 x 9,50 28.5"x4.5"x.375" | 5 1/2"-13 NC | 5,50 | 057.02F220 | * |
| | | | | 057.02F3000 | * |
| 30" | 863,6 x 127 x 12,57 34" x 5" x .495" | 6 1/2"-12 | 9,50 | 057.06F220 | * |
| | | | | 057.06F3000 | * |
| 34" | 965,2 x 127 x 12,57 38" x 5" x .495" | 7 1/2"-12 | 10,65 | 057.05F220 | * |
| | | | | 057.05F3000 | * |

Für alle PEERLESS GEM-Typen ist eine Zeichnung erforderlich.
For all PEERLESS GEM-types a drawing is required.

PERFECTA



| Maschinen-Typ Type/Type/Tipo | Abmessungen in mm Size/Dimension/Tamaño | Löcher/Holes Trous/Huecos | ⚖️ kg | FASSCO-Id. Qualität/Quality/Calid. | €/Stück Pce./Pce./Pza. |
|---|--|---|----------|---------------------------------------|---------------------------|
| H 72 | 830 x 100 x 8 | 5/M12x1,5 | 4,55 | 005.01F220 | * |
| | | | | 005.01F3000 | * |
| 76 SP/SC 76 UC/HTVC | 935 x 110 x 11,7 48.22.063 3232911 F-8000 s. sep.Tabelle – s. sep. table | 14/M12 +MWE | 8,05 | 005.22F220 | 246,00 |
| | | | | 005.22F3000 | 317,00 |
| Asp 78 Ac 78 | 960 x 128 x 9 | 16/M12x1,5 | 7,60 | 005.03F220 | * |
| | | | | 005.03F3000 | * |
| P78 ECO-Line >2016 | 980 x 127 x 12,7 | 18/M10 +MWE | 10,75 | 005.42F220 | 385,00 |
| | | | | 005.42F3000 | 490,00 |
| Asp/Apv/Acmb Apa/Ac 83 | 995 x 132 x 10 48.22.003 | 18/M12x1,5 | 9,15 | 005.04F220 | * |
| | | | | 005.04F3000 | * |
| P80 >2019 | 996 x 140 x 13 | 24/M12 +MWE | 12,75 | 005.44F220 | 406,00 |
| | | | | 005.44F3000 | 516,00 |
| S 86/87 | 1070 x 140 x 12 48.22.004 | 21/M12x1,5 | 12,40 | 005.07F220 | * |
| | | | | 005.07F3000 | * |
| S /SEY 87 SEYPA 92 Serie >06/73 | 1090 x 140 x 12 48.22.060 | 21/M12x1,5 +MWE | 12,70 | 005.19F220 | 379,00 |
| | | | | 005.19F3000 | 519,00 |
| 92 UC/HTVC Serie >05/95 | 1085 x 140 x 13 48.22.081 3232912 F-8000 s. sep.Tabelle – s. sep. table | 24/M12 +MWE | 13,45 | 005.23F220 | 406,00 |
| | | | | 005.23F3000 | 516,00 |
| Asp 105 Ac 105 | 1260 x 128 x 9 | 22/M12x1,5 | 9,85 | 005.05F220 | * |
| | | | | 005.05F3000 | * |
| Apv/Apa Asp 106 | 1260 x 136 x 11 | 24/M12x1,5 | 13,05 | 005.06F220 | * |
| | | | | 005.06F3000 | * |
| S /SEY 107 SEY PA 107 | 1270 x 140 x 12 48.22.034 | 24/M12x1,5 +MWE | 14,70 | 005.11F220 | * |
| | | | | 005.11F3000 | * |
| S/SEYPA 107 SEYPA 115 P 115 TS Drupa 2012 | 1350 x 140 x 12 48.22.040-1 3232703 F-8000 s. sep.Tabelle – s. sep. table | 30/M12x1,5 +MWE alt&neu old&new qu.change | 15,60 | 005.27F220 | 427,00 |
| | | | | 005.27F3000 | 640,00 |
| P 132 TS/L-TS S/SEYPA 132 132 TS/L-TS Drupa 2012 | 1515 x 140 x 12 48.22.037-1 3232704 F-8000 s. sep.Tabelle – s. sep. table | 30/M12x1,5 +MWE alt&neu old&new qu.change | 17,45 | 005.28F220 | 469,00 |
| | | | | 005.28F3000 | 700,00 |
| P132 ECO-Line >2016 | 1605 x 160 x 13,7 | 30/M12 +MWE | 24,50 | 005.43F220 | 587,00 |
| | | | | 005.43F3000 | 799,00 |
| P 168 TS/L-TS S 167 H/HA SEYPA 168 Drupa 2012 | 1880 x 160 x 14 48.22.011-1 3232705 F-8000 s. sep.Tabelle – s. sep. table | 45/M12 +MWE alt&neu old&new qu.change | 29,20 | 005.33F220 | 820,00 |
| | | | | 005.33F3000 | 1.180,00 |
| S 220/225 SEYPA 225 225 TS/L-TS | 2450 x 160 x 14 48.22.014 3232916 F-8000 s. sep.Tabelle – s. sep. table | 57/M12 +MWE | 38,15 | 005.14F220 | 1.130,00 |
| | | | | 005.14F3000 | 1.620,00 |

| Maschinen-Typ Type/Type/Tipo | Abmessungen in mm Size/Dimension/Tamaño | Löcher/Holes Trous/Huecos | △ kg | FASSCO-Id. Qualität/Quality/Calid. | €/Stück Pce./Pce./Pza. |
|--|--|---|---------|---------------------------------------|---------------------------|
| 76 SP/SC 76 UC/HTVC | 935 x 95 x 11,7 48.22.062 | 7/M12 +MWE | 7,30 | 005.24F8000 | * |
| | | | | 005.24F8020 | * |
| | | | | 005.24F8040 | * |
| 92 UC/HTVC Serie >05.95 | 1085 x 105 x 13 48.22.080 | 8/M12 +MWE | 10,40 | 005.25F8000 | * |
| | | | | 005.25F8020 | * |
| | | | | 005.25F8040 | * |
| S/SEYPA 107 SEYPA 115 Serie >09/69 P 115 TS Drupa 2012 | 1350 x 140 x 12 48.22.041-1 3232773 | 20/M12x1,5 +MWE alt&neu old&new qu.change | 15,60 | 005.29F8000 | * |
| | | | | 005.29F8020 | * |
| | | | | 005.29F8040 | * |
| S 132 TS/L-TS SEYPA 132 P 132 TS/LTS Drupa 2012 | 1515 x 140 x 12 48.22.038-1 3232774 | 20/M12x1,5 +MWE alt&neu old&new qu.change | 17,45 | 005.30F8000 | * |
| | | | | 005.30F8020 | * |
| | | | | 005.30F8040 | * |
| S 167 H/HA SEYPA 168 P 168 TS/L-TS Drupa 2012 | 1880 x 160 x 14 | 30/M12 +MWE alt&neu old&new qu.change | 29,20 | 005.35F8000 | * |
| | | | | 005.35F8020 | * |
| | | | | 005.35F8040 | * |
| S 220/225 SEYPA 225 225 TS/L-TS | 2450 x 160 x 14 | 38/M12 +MWE | 38,15 | 005.39F8000 | * |
| | | | | 005.39F8020 | * |
| | | | | 005.39F8040 | * |

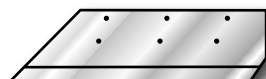

PERFECTA

| Maschinen-Typ Type/Type/Tipo | Abmessungen in mm Size/Dimension/Tamaño | Löcher/Holes Trous/Huecos | △ kg | FASSCO-Id. Qualität/Quality/Calid. | €/Stück Pce./Pce./Pza. |
|----------------------------------|---|------------------------------|---------|---------------------------------------|---------------------------|
| SDY-2 SDY-1 Format 300x420 | Vordermesser 570 x 115 x 10 (48.22.027) | 8/M12x1,5 | 4,55 | 005.96/001F220 | 195,00 |
| | | | | 005.96/001F3000 | 245,00 |
| | Seitenmesser, links 500 x 115 x 10 (48.22.027) | 6/M12x1,5 | 3,25 | 005.96/002F220 | 172,00 |
| | | | | 005.96/002F3000 | 215,00 |
| | Seitenmesser, rechts 500 x 115 x 10 (48.22.027) | 6/M12x1,5 | 3,25 | 005.96/003F220 | 172,00 |
| | | | | 005.96/003F3000 | 215,00 |
| €/Satz/Set/Jeu/Juego | | | | | |
| SDY-1 SDY-2 Format 300x420 | kompletter Satz complete set | = 3 Messer = 3 knives | 11,05 | 005.96/300F220 | 539,00 |
| | | | | 005.96/300F3000 | 675,00 |

PERFECTA

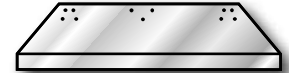

| Maschinen-Typ Type/Type/Tipo | Abmessungen in mm Size/Dimension/Tamaño | Löcher/Holes Trous/Huecos | kg | FASSCO-Id. Qualität/Quality/Calid. | €/Stück Pce./Pce./Pza. |
|-----------------------------------|---|------------------------------|-------|---------------------------------------|---------------------------|
| Trim Star 80/110 SDF 75/100 | Vordermesser 580 x 115 x 10 (48.22.031) | 8/M12x1,5 | 4,70 | 005.99/001F220 | 204,00 |
| | | | | 005.99/001F3000 | 253,00 |
| | Seitenmesser, links 450 x 115 x 10 (48.22.031) | 11/M12x1,5 | 2,85 | 005.99/023F220 | 183,00 |
| | | | | 005.99/023F3000 | 227,00 |
| | Seitenmesser, rechts 450 x 115 x 10 (48.22.031) | 11/M12x1,5 | 2,85 | 005.99/023F220 | 183,00 |
| | | | | 005.99/023F3000 | 227,00 |
| €/Satz/Set/Jeu/Juego | | | | | |
| Trim Star 80/110 SDF 75/100 | kompletter Satz complete set | = 3 Messer = 3 knives | 10,40 | 005.99/300F220 | 570,00 |
| | | | | 005.99/300F3000 | 707,00 |

| Maschinen-Typ Type/Type/Tipo | Abmessungen in mm Size/Dimension/Tamaño | Löcher/Holes Trous/Huecos | kg | FASSCO-Id. Qualität/Quality/Calid. | €/Stück Pce./Pce./Pza. |
|--|--|------------------------------|------|---------------------------------------|---------------------------|
| Trim Star 80/110 SDF 75/100 Hartmetall TCT | Vordermesser 580 x 95 x 10 (48.22.019) | 4/M12x1,5 | 4,00 | 005.89/001F8000 | * |
| | Seitenmesser, links 430 x 95 x 10 (48.22.019) | 4/M12x1,5 | 2,35 | 005.89/023F8000 | * |
| | Seitenmesser, rechts 430 x 95 x 10 (48.22.019) | 4/M12x1,5 | 2,35 | 005.89/023F8000 | * |
| €/Satz/Set/Jeu/Juego | | | | | |
| Trim Star 80/110 SDF 75/100 Hartmetall | kompletter Satz complete set | = 3 Messer = 3 knives | 8,70 | 005.89/300F8000 | * |

PERFECTA

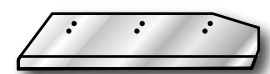

| Maschinen-Typ Type/Type/Tipo | Abmessungen in mm Size/Dimension/Tamaño | Löcher/Holes Trous/Huecos | kg | FASSCO-Id. Qualität/Quality/Calid. | €/Stück Pce./Pce./Pza. |
|---------------------------------|---|------------------------------|------|---------------------------------------|---------------------------|
| Circuit 40 F BoD/ Bod-F | Vordermesser 580 x 115 x 10 (48.22.104-1) | 8/M12x1,5 | 4,70 | 005.88/001F220 | * |
| | | | | 005.88/001F3000 | * |
| | Seitenmesser, links 417 x 115 x 10 (48.22.104-1) | 6/M12x1,5 | 2,60 | 005.88/002F220 | * |
| | | | | 005.88/002F3000 | * |
| | Seitenmesser, rechts 417 x 115 x 10 (48.22.104-1) | 6/M12x1,5 | 2,60 | 005.88/003F220 | * |
| | | | | 005.88/003F3000 | * |
| €/Satz/Set/Jeu/Juego | | | | | |
| Circuit 40 F BoD/ Bod-F | kompletter Satz complete set | = 3 Messer = 3 knives | 9,90 | 005.88/300F220 | * |
| | | | | 005.88/300F3000 | * |

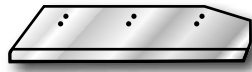

PERFECTA

| Maschinen-Typ Type/Type/Tipo | Abmessungen in mm Size/Dimension/Tamaño | Löcher/Holes Trous/Huecos | △ kg | FASSCO-Id. Qualität/Quality/Calid. | €/Stück Pce./Pce./Pza. |
|-----------------------------------|--|------------------------------|---------|---------------------------------------|---------------------------|
| Circuit 40 F Hartmetall TCT | Vordermesser 580 x 95 x 10 | 4/M12x1,5 | 4,00 | 005.87/001F8000 | * |
| | Seitenmesser, links 417 x 95 x 10 | 3/M12x1,5 | 2,18 | 005.87/002F8000 | * |
| | Seitenmesser, rechts 417 x 95 x 10 | 3/M12x1,5 | 2,18 | 005.87/003F8000 | * |
| €/Satz/Set/Jeu/Juego | | | | | |
| Circuit 40 F Hartmetall TCT | kompletter Satz complete set | = 3 Messer = 3 knives | 8,36 | 005.87/300F8000 | * |

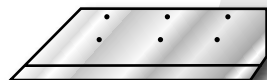

PERFECTA

| Maschinen-Typ Type/Type/Tipo | Abmessungen in mm Size/Dimension/Tamaño | Löcher/Holes Trous/Huecos | △ kg | FASSCO-Id. Qualität/Quality/Calid. | €/Stück Pce./Pce./Pza. |
|---|--|------------------------------|---------|---------------------------------------|---------------------------|
| Circuit 40 Trennschnitt Split cut | Vordermesser 465 x 115 x 10 (48.22.110) | 6/M12x1,5 | 3,50 | 005.86/001F220 | * |
| | | | | 005.86/001F3000 | * |
| | Seitenmesser, links 417 x 115 x 10 (48.22.104-1) (48.22.110) | 6/M12x1,5 | 2,60 | 005.88/002F220 | * |
| | | | | 005.88/002F3000 | * |
| | Seitenmesser, rechts 417 x 115 x 10 (48.22.104-1) (48.22.110) | 6/M12x1,5 | 2,60 | 005.88/003F220 | * |
| | | | | 005.88/003F3000 | * |
| €/Satz/Set/Jeu/Juego | | | | | |
| Circuit 40 Trennschnitt Split cut | kompletter Satz complete set | = 3 Messer = 3 knives | 8,70 | 005.86/300F220 | * |
| | | | | 005.86/300F3000 | * |

| Maschinen-Typ Type/Type/Tipo | Abmessungen in mm Size/Dimension/Tamaño | Löcher/Holes Trous/Huecos | △ kg | FASSCO-Id. Qualität/Quality/Calid. | €/Stück Pce./Pce./Pza. |
|---------------------------------|---|------------------------------|---------|---------------------------------------|---------------------------|
| SDY-EZ SDY-EZ-1 | Vordermesser 540 x 115 x 10 (48.22.024) | 8/M12x1,5 | 4,25 | 005.95/001F220 | 172,00 |
| | | | | 005.95/001F3000 | 224,00 |
| | Seitenmesser, links 420 x 115 x 10 (48.22.024) | 6/M12x1,5 | 2,85 | 005.95/002F220 | 139,00 |
| | | | | 005.95/002F3000 | 181,00 |
| | Seitenmesser, rechts 420 x 115 x 10 (48.22.024) | 6/M12x1,5 | 2,85 | 005.95/003F220 | 139,00 |
| | | | | 005.95/003F3000 | 181,00 |
| €/Satz/Set/Jeu/Juego | | | | | |
| SDY-EZ SDY-EZ-1 | kompletter Satz complete set | = 3 Messer = 3 knives | 9,95 | 005.95/300F220 | 450,00 |
| | | | | 005.95/300F3000 | 586,00 |

PERFECTA

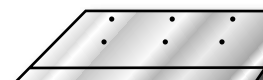
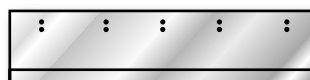

| Maschinen-Type Type/Type/Tipo | Abmessungen in mm Size/Dimension/Tamaño | Löcher/Holes Trous/Huecos | kg | FASSCO-Id. Qualität/Quality/Calid. | €/Stück Pce./Pce./Pza. |
|----------------------------------|---|------------------------------|-------|---------------------------------------|---------------------------|
| SDY Format 350x500 | Vordermesser 660 x 115 x 10 (48.22.029) | 8/M12x1,5 | 5,25 | 005.97/001F220 | * |
| | | | | 005.97/001F3000 | * |
| | Seitenmesser, links 500 x 115 x 10 (48.22.029) | 6/M12x1,5 | 3,50 | 005.97/002F220 | * |
| | | | | 005.97/002F3000 | * |
| | Seitenmesser, rechts 500 x 115 x 10 (48.22.029) | 6/M12x1,5 | 3,50 | 005.97/003F220 | * |
| | | | | 005.97/003F3000 | * |
| €/Satz/Set/Jeu/Juego | | | | | |
| SDY Format 350x500 | kompletter Satz complete set | = 3 Messer = 3 knives | 12,25 | 005.97/300F220 | * |
| | | | | 005.97/300F3000 | * |

| Maschinen-Type Type/Type/Tipo | Abmessungen in mm Size/Dimension/Tamaño | Löcher/Holes Trous/Huecos | kg | FASSCO-Id. Qualität/Quality/Calid. | €/Stück Pce./Pce./Pza. |
|--|--|------------------------------|-------|---------------------------------------|---------------------------|
| SDY Formathöhe 250mm und für Trennschnitt Cutting height 250mm and for Split cut | Vordermesser 660 x 115 x 10 | 8/M12x1,5 | 5,25 | 005.97/001F220 | * |
| | | | | 005.97/001F3000 | * |
| | Seitenmesser, links 500 x 115 x 10 | 6/M12x1,5 | 3,55 | 005.98/002F220 | * |
| | | | | 005.98/002F3000 | * |
| | Seitenmesser, rechts 500 x 115 x 10 | 6/M12x1,5 | 3,55 | 005.98/003F220 | * |
| | | | | 005.98/003F3000 | * |
| €/Satz/Set/Jeu/Juego | | | | | |
| SDY | kompletter Satz complete set | = 3 Messer = 3 knives | 12,35 | 005.98/300F220 | * |
| | | | | 005.98/300F3000 | * |

PERFECTA



| Maschinen-Type Type/Type/Tipo | Abmessungen in mm Size/Dimension/Tamaño | Löcher/Holes Trous/Huecos | kg | FASSCO-Id. Qualität/Quality/Calid. | €/Stück Pce./Pce./Pza. |
|----------------------------------|---|------------------------------|-------|---------------------------------------|---------------------------|
| ADN 30/42 D 30/42 | Vordermesser 560 x 132 x 10 (48.22.021) | 10/M12x1,5 | 5,05 | 005.90/001F220 | * |
| | | | | 005.90/001F3000 | * |
| | Seitenmesser, links 452 x 132 x 10 (48.22.021) | 8/M12x1,5 | 3,60 | 005.90/002F220 | * |
| | | | | 005.90/002F3000 | * |
| | Seitenmesser, rechts 452 x 132 x 10 (48.22.021) | 8/M12x1,5 | 3,60 | 005.90/003F220 | * |
| | | | | 005.90/003F3000 | * |
| €/Satz/Set/Jeu/Juego | | | | | |
| ADN 30/42 D 30/42 | kompletter Satz complete set | = 3 Messer = 3 knives | 12,25 | 005.90/300F220 | * |
| | | | | 005.90/300F3000 | * |

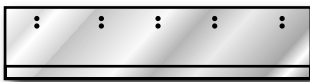

PERFECTA

| Maschinen-Type Type/Type/Tipo | Abmessungen in mm Size/Dimension/Tamaño | Löcher/Holes Trous/Huecos | ⚖ kg | FASSCO-Id. Qualität/Quality/Calid. | €/Stück Pce./Pce./Pza. |
|---|---|------------------------------|---------|---------------------------------------|---------------------------|
| D 30/42 vergrößertes Format enlarged size | Vordermesser 640 x 132 x 10 (48.22.022) | 10/M12x1,5 | 5,75 | 005.94/001F220 | * |
| | | | | 005.94/001F3000 | * |
| | Seitenmesser, links 492 x 132 x 10 (48.22.022) | 8/M12x1,5 | 3,95 | 005.94/002F220 | * |
| | | | | 005.94/002F3000 | * |
| | Seitenmesser, rechts 492 x 132 x 10 (48.22.022) | 8/M12x1,5 | 3,95 | 005.94/003F220 | * |
| | | | | 005.94/003F3000 | * |
| €/Satz/Set/Jeu/Juego | | | | | |
| D 30/42 vergrößertes Format enlarged size | kompletter Satz complete set | = 3 Messer = 3 knives | 13,65 | 005.94/300F220 | * |
| | | | | 005.94/300F3000 | * |

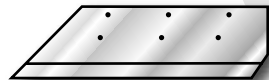

PERFECTA

| Maschinen-Type Type/Type/Tipo | Abmessungen in mm Size/Dimension/Tamaño | Löcher/Holes Trous/Huecos | ⚖ kg | FASSCO-Id. Qualität/Quality/Calid. | €/Stück Pce./Pce./Pza. |
|----------------------------------|--|------------------------------|---------|---------------------------------------|---------------------------|
| ADF 25/35 JOHNE | Vordermesser 475 x 128 x 8 | 8/M12x1,5 | 3,35 | 005.91/001F220 | * |
| | | | | 005.91/001F3000 | * |
| | Seitenmesser, links 400 x 128 x 8 | 6/M12x1,5 | 2,45 | 005.91/002F220 | * |
| | | | | 005.91/002F3000 | * |
| | Seitenmesser, rechts 400 x 128 x 8 | 6/M12x1,5 | 2,45 | 005.91/003F220 | * |
| | | | | 005.91/003F3000 | * |
| €/Satz/Set/Jeu/Juego | | | | | |
| ADF 25/35 JOHNE | kompletter Satz complete set | = 3 Messer = 3 knives | 8,25 | 005.91/300F220 | * |
| | | | | 005.91/300F3000 | * |

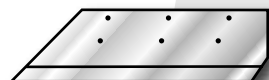

PERFECTA

| Maschinen-Type Type/Type/Tipo | Abmessungen in mm Size/Dimension/Tamaño | Löcher/Holes Trous/Huecos | ⚖ kg | FASSCO-Id. Qualität/Quality/Calid. | €/Stück Pce./Pce./Pza. |
|----------------------------------|--|------------------------------|---------|---------------------------------------|---------------------------|
| ADF 30x42,5 JOHNE | Vordermesser 560 x 128 x 8 | 10/M12x1,5 | 3,95 | 005.93/001F220 | * |
| | | | | 005.93/001F3000 | * |
| | Seitenmesser, links 450 x 128 x 8 | 6/M12x1,5 | 2,76 | 005.93/002F220 | * |
| | | | | 005.93/002F3000 | * |
| | Seitenmesser, rechts 450 x 128 x 8 | 6/M12x1,5 | 2,76 | 005.93/003F220 | * |
| | | | | 005.93/003F3000 | * |
| €/Satz/Set/Jeu/Juego | | | | | |
| ADF 30x42,5 JOHNE | kompletter Satz complete set | = 3 Messer = 3 knives | 9,47 | 005.93/300F220 | * |
| | | | | 005.93/300F3000 | * |

PERFECTA

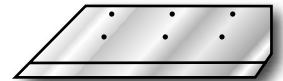
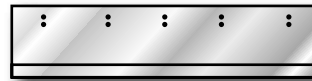

| Maschinen-Type Type/Type/Tipo | Abmessungen in mm Size/Dimension/Tamaño | Löcher/Holes Trous/Huecos | kg | FASSCO-Id. Qualität/Quality/Calid. | €/Stück Pce./Pce./Pza. |
|----------------------------------|---|------------------------------|-------|---------------------------------------|---------------------------|
| ADF 25/35 | Vordermesser 475 x 128 x 10 (48.22.020) | 8/M12x1,5 | 4,15 | 005.92/001F220 | * |
| | | | | 005.92/001F3000 | * |
| | Seitenmesser, links 400 x 128 x 10 (48.22.020) | 6/M12x1,5 | 3,05 | 005.92/002F220 | * |
| | | | | 005.92/002F3000 | * |
| | Seitenmesser, rechts 400 x 128 x 10 (48.22.020) | 6/M12x1,5 | 3,05 | 005.92/003F220 | * |
| | | | | 005.92/003F3000 | * |
| €/Satz/Set/Jeu/Juego | | | | | |
| ADF 25/35 | kompletter Satz complete set | = 3 Messer = 3 knives | 10,25 | 005.92/300F220 | * |
| | | | | 005.92/300F3000 | * |





| Maschinen-Typ Type/Type/Tipo | Abmessungen in mm Size/Dimension/Tamaño | Löcher/Holes Trous/Huecos | kg | FASSCO-Id. Qualität/Quality/Calid. | €/Stück Pce./Pce./Pza. |
|---------------------------------|--|------------------------------|-------|---------------------------------------|---------------------------|
| FG 52 | 680 x 123 x 8 (10009) | 10/M12x1,5 | 4,65 | 006.01F220 | * |
| | | | | 006.01F3000 | * |
| FG 78 | 965 x 125 x 9 | 16/M12x1,5 | 7,50 | 006.02F220 | * |
| | | | | 006.02F3000 | * |
| FG 76 | 1005 x 120 x 10 (18081) | 14/M12x1,5 | 8,35 | 006.16F220 | * |
| | | | | 006.16F3000 | * |
| FG 82S | 1025 x 128 x 9 (2192) | 16/M12x1,5 | 8,20 | 006.03F220 | * |
| | | | | 006.03F3000 | * |
| FG 82A | 1045 x 125 x 9 | 18/M12x1,5 | 8,15 | 006.04F220 | * |
| | | | | 006.04F3000 | * |
| FG 82 SRHE 82R/ 82H | 1070 x 129 x 10 | 18/M12x1,5 | 9,55 | 006.05F220 | * |
| | | | | 006.05F3000 | * |
| FG 92 | 1185 x 145 x 11 | 27/M12x1,5 | 13,10 | 006.20F220 | * |
| | | | | 006.20F3000 | * |
| 92 | 1275 x 145 x 12 | 30/M12x1,5 | 15,30 | 006.21F220 | * |
| | | | | 006.21F3000 | * |
| FG 105 | 1280 x 125 x 9 | 22/M12x1,5 | 9,95 | 006.06F220 | * |
| | | | | 006.06F3000 | * |
| FG 103S/N | 1317 x 145 x 12 | 30/M12x1,5 | 15,90 | 006.13F220 | * |
| | | | | 006.13F3000 | * |
| FG 107 | 1364 x 140 x 10 (12012) | 24/M12x1,5 | 13,25 | 006.07F220 | * |
| | | | | 006.07F3000 | * |
| FG 108 | 1395 x 145 x 12 | 33/M12x1,5 | 16,85 | 006.18F220 | * |
| | | | | 006.18F3000 | * |
| FG 107H | 1400 x 145 x 10 | 36/M12x1,5 | 14,05 | 006.12F220 | * |
| | | | | 006.12F3000 | * |
| FG 113 | 1400 x 130 x 9 (0287) | 24/M12x1,5 | 11,30 | 006.08F220 | * |
| | | | | 006.08F3000 | * |
| FG 112H | 1412 x 143 x 10 | 24/M12x1,5 | 13,95 | 006.14F220 | * |
| | | | | 006.14F3000 | * |
| FG 130 | 1578 x 140 x 11 (1097) | 28/M12x1,5 | 16,85 | 006.09F220 | * |
| | | | | 006.09F3000 | * |
| FG 118H FG 125 | 1587 x 145 x 13 (15081/1) | 36/M12x1,5 | 20,75 | 006.15F220 | * |
| | | | | 006.15F3000 | * |
| FG 129 | 1590 x 140 x 12 | 36/M12x1,5 | 18,55 | 006.17F220 | * |
| | | | | 006.17F3000 | * |
| FG 135H | 1670 x 155 x 13 (13009) | 28/M12x1,5 | 23,35 | 006.10F220 | * |
| | | | | 006.10F3000 | * |
| FG 170H/M | 1957 x 180 x 18 (8501/1) | 34/M12x1,5 | 44,10 | 006.19F220 | * |
| | | | | 006.19F3000 | * |
| FG 170 | 2012 x 180 x 18 (8501) | 34/M12x1,5 | 45,30 | 006.11F220 | * |
| | | | | 006.11F3000 | * |

PIVANO

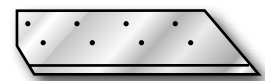
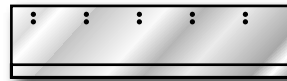

| Maschinen-Typ Type/Type/Tipo | Abmessungen in mm Size/Dimension/Tamaño | Löcher/Holes Trous/Huecos | △ kg | FASSCO-Id. Qualität/Quality/Calid. | €/Stück Pce./Pce./Pza. |
|---------------------------------|---|------------------------------|---------|---------------------------------------|---------------------------|
| TRIS 30/40 | Vordermesser 538 x 128 x 8 (5501) | 10/M12x1,5 | 3,80 | 006.90/001F220 | * |
| | | | | 006.90/001F3000 | * |
| | Seitenmesser, links 458 x 128 x 8 (5403) | 8/M12x1,5 | 2,75 | 006.90/002F220 | * |
| | | | | 006.90/002F3000 | * |
| | Seitenmesser, rechts 458 x 128 x 8 (5402) | 8/M12x1,5 | 2,75 | 006.90/003F220 | * |
| | | | | 006.90/003F3000 | * |
| €/Satz/Set/Jeu/Juego | | | | | |
| TRIS 30/40 | kompletter Satz complete set | = 3 Messer = 3 knives | 9,30 | 006.90/300F220 | * |
| | | | | 006.90/300F3000 | * |



| Maschinen-Typ Type/Type/Tipo | Abmessungen in mm Size/Dimension/Tamaño | Löcher/Holes Trous/Huecos | △ kg | FASSCO-Id. Qualität/Quality/Calid. | €/Stück Pce./Pce./Pza. |
|---------------------------------|--|------------------------------|---------|---------------------------------------|---------------------------|
| TRIS 31x45 | Vordermesser 588 x 128 x 8 (A5501) | 10/M12x1,5 | 4,15 | 006.91/001F220 | * |
| | | | | 006.91/001F3000 | * |
| | Seitenmesser, links 468 x 128 x 8 (A5403) | 8/M12x1,5 | 2,80 | 006.91/002F220 | * |
| | | | | 006.91/002F3000 | * |
| | Seitenmesser, rechts 468 x 128 x 8 (A5402) | 8/M12x1,5 | 2,80 | 006.91/003F220 | * |
| | | | | 006.91/003F3000 | * |
| €/Satz/Set/Jeu/Juego | | | | | |
| TRIS 31x45 | kompletter Satz complete set | = 3 Messer = 3 knives | 9,75 | 006.91/300F220 | * |
| | | | | 006.91/300F3000 | * |

| Maschinen-Typ Type/Type/Tipo | Abmessungen in mm Size/Dimension/Tamaño | Löcher/Holes Trous/Huecos | △ kg | FASSCO-Id. Qualität/Quality/Calid. | €/Stück Pce./Pce./Pza. |
|---------------------------------|---|------------------------------|---------|---------------------------------------|---------------------------|
| 31-45 RT | Vordermesser 570 x 115 x 10 (16616/1) | 10/M12x1,5 | 4,55 | 006.92/001F220 | * |
| | | | | 006.92/001F3000 | * |
| | Seitenmesser, links 457 x 115 x 10 (16523/1) | 8/M12x1,5 | 3,15 | 006.92/002F220 | * |
| | | | | 006.92/002F3000 | * |
| | Seitenmesser, rechts 457 x 115 x 10 (16521/1) | 8/M12x1,5 | 3,15 | 006.92/003F220 | * |
| | | | | 006.92/003F3000 | * |
| €/Satz/Set/Jeu/Juego | | | | | |
| 31-45 RT | kompletter Satz complete set | = 3 Messer = 3 knives | 10,85 | 006.92/300F220 | * |
| | | | | 006.92/300F3000 | * |

Stahlmesser / Steel knives

Qualität / Quality:

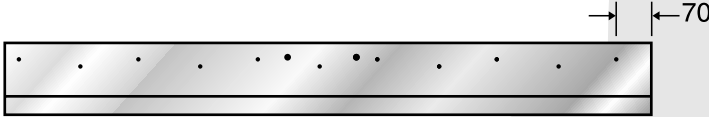
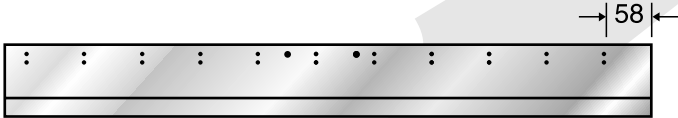
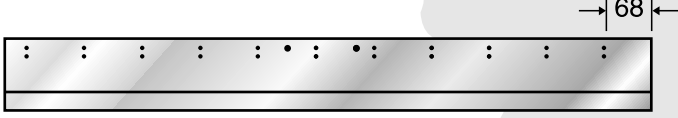
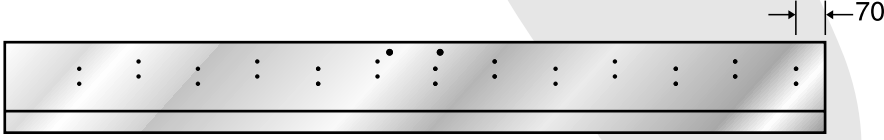
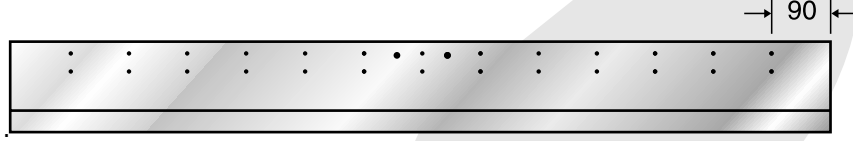
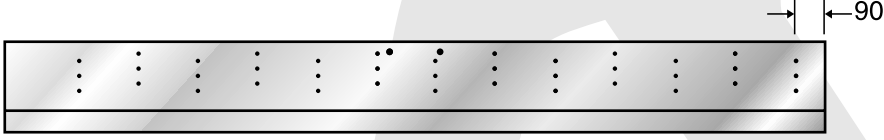
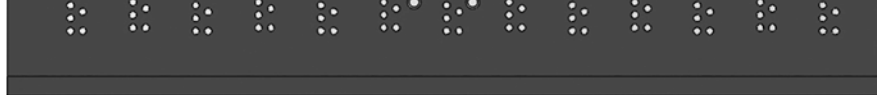
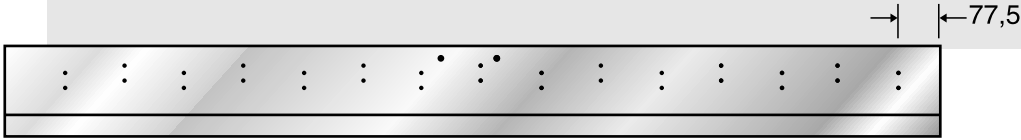
FASSCO F-220 · FASSCO F-3000

| Polar | |
|-----------|---|
| Modell 1 | <p>POLAR 92 FASSCO-Nr. 007.26 Messer kann ab 86 EL Masch.Nr. 69001 verwendet werden.</p>  |
| Modell 2 | <p>POLAR 92 FASSCO-Nr. 007.34</p>  |
| Modell 12 | <p>POLAR 92 FASSCO-Nr. 007.40</p>  |
| Modell 3 | <p>POLAR 115 FASSCO-Nr. 007.24 Messer kann ab 107 Masch.Nr. 57601 verwendet werden.</p>  |
| Modell 4 | <p>POLAR 115 FASSCO-Nr. 007.31</p>  |
| Modell 14 | <p>POLAR 115 FASSCO-Nr. 007.41</p>  |
| | <p>FASSCO-Nr. 007.57</p>  |
| Modell 5 | <p>POLAR 137 FASSCO-Nr. 007.27</p>  |
| | <p>FASSCO-Nr. 007.12 FASSCO-Nr. 007.20</p>  |

Stahlmesser/Steel knives

Qualität / Quality:

FASSCO F-220 · FASSCO F-3000

| Polar | |
|-----------|---|
| Modell 6 | <p>POLAR 137 FASSCO-Nr. 007.32</p> <p>→ 88 ←</p> |
| Modell 15 | <p>POLAR 137 FASSCO-Nr. 007.42</p> <p>→ 88 ←</p> |
| Modell 7 | <p>POLAR 155 FASSCO-Nr. 007.25 Messer kann ab 145 Masch.Nr. 58974 verwendet werden.</p> <p>→ 145 ←</p> |
| Modell 8 | <p>POLAR 155 FASSCO-Nr. 007.33</p> <p>→ 160 ←</p> |
| Modell 17 | <p>POLAR 155 FASSCO-Nr. 007.43</p> <p>→ 160 ←</p> |
| Modell 9 | <p>POLAR 176 FASSCO-Nr. 007.45</p> <p>→ 150 ←</p> |
| Modell 10 | <p>POLAR 176 FASSCO-Nr. 007.35</p> <p>→ 160 ←</p> |
| Modell 19 | <p>POLAR 176 FASSCO-Nr. 007.44</p> <p>→ 160 ←</p> |

| Maschinen-Typ Type/Type/Tipo | Abmessungen in mm Size/Dimension/Tamaño | Löcher/Holes Trous/Huecos |  kg | FASSCO-Id. Qualität/Quality/Calid. | €/Stück Pce./Pce./Pza. |
|--|--|---------------------------------|---|---------------------------------------|---------------------------|
| 25 Autocut | 410 x 165 x 9,75 | 4/M12 2/M10 | 4,40 | 007.51F8000 | * |
| 55 | 685 x 95 x 9,7 | 14/M10 | 4,20 | 007.29F220 | 156,00 |
| | 241580 (F2) | | | 007.29F3000 | 219,00 |
| | 245196 (F3) | | | | |
| P56 N | 241787 (F8) | 12/M10 | 4,35 | 007.59F220 | 156,00 |
| | 695 x 95 x 9,7 | | | 007.59F3000 | 219,00 |
| | 462655 (F3) | | | | |
| 58 EL | 464304 (F8) | 12/M10 | 4,50 | 007.30F220 | 156,00 |
| | 715 x 95 x 9,7 | | | 007.30F3000 | 219,00 |
| | 248356 (F2) | | | | |
| 66 | 248875 (F3) | 14/M10 | 5,00 | 007.46F220 | 167,00 |
| | 248876 (F8) | | | 007.46F3000 | 233,00 |
| | 805 x 95 x 9,7 | | | | |
| 71 72 | 279034 (F2) | 12/M10 | 6,00 | 007.09F220 | 175,00 |
| | 280403 (F3) | | | 007.09F3000 | 254,00 |
| | 868 x 104 x 9,7 | | | | |
| 76 EL | 207766 (F2) | 14/M10 | 6,85 | 007.28F220 | 200,00 |
| | 215223 (F3) | | | 007.28F3000 | 280,00 |
| | 218622 (F8) | | | | |
| 78 JUNIOR 80 bis Masch.-Nr. 57560 | 925 x 110 x 9,7 | 6/M10 | 6,95 | 007.01F220 | * |
| | 233231 (F2) | | | 007.01F3000 | * |
| | 245197 (F3) | | | | |
| 78EL neu 78 S/E/ED Serie 1/95 78 X/XS/XT | 233232 (F8) | 18/M10 + MWE | 8,30 | 007.39F220 | 220,00 |
| | 960 x 107 x 9,7 | | | 007.39F3000 | 325,00 |
| | 208864 (F2) | | | | |
| 80 ab Masch.- Nr. 58001 82 EL ab Serie 1/63 | 208865 (F3) | 10/M10 | 7,15 | 007.03F220 | 205,00 |
| | 990 x 107 x 9,7 | | | 007.03F3000 | 285,00 |
| | 208867 (F2) | | | | |
| 82 EL/ET 82 ST/HY Serie 1/67 | 218623 (F8) | 10/M10 | 8,35 | 007.04F220 | 240,00 |
| | 990 x 107 x 11,7 | | | 007.04F3000 | 327,00 |
| | 208870 (F2) | | | | |
| 86/88 EL/ST 90 EL/ST | 208871 (F3) | 10/M10 | 8,65 | 007.05F220 | 285,00 |
| | 218618 (F8) | | | 007.05F3000 | 370,00 |
| | 1030 x 107 x 11,7 | | | | |
| 86 EL Serie 3/69 90 EL | 208874 (F3) | 11/M10 | 10,00 | 007.06F220 | 285,00 |
| | 1080 x 115 x 11,7 | | | 007.06F3000 | 370,00 |
| | 206003 (F2) | | | | |
| 92 EL/EM/EMC 90 CE 92 CE | 206004 (F2) | 11/M10 | 10,15 | 007.26F220 | 260,00 |
| | 1095 x 115 x 11,7 | | | 007.26F3000 | 360,00 |
| | 219615-6/222750 (F2) | | | | |
| | 245184 (F3) | versetzt + MWE s.Modell 1 | | | |
| | 219617/222752 (F8) | | | | |
| | Messer kann ab 86EL Masch.Nr. 69001 verw. werden. Knife can be used from 86EL machine-no. 69001 | | | | |



| Maschinen-Typ Type/Type/Tipo | Abmessungen in mm Size/Dimension/Tamaño | Löcher/Holes Trous/Huecos | △ kg | FASSCO-Id. Qualität/Quality/Calid. | €/Stück Pce./Pce./Pza. |
|--|--|---|---------|---------------------------------------|---------------------------|
| 92 Autocut | 1095 x 115 x 11,7 248308 (F8) | 22/M10 + MWE | 10,15 | 007.36F3000 | 360,00 |
| 92 EM/EMC 92 SD/MON Serie 9/90 | 1095 x 115 x 11,7 258046 (F3) 258048 (F8) | 22/M10 gerade + MWE s.Modell 2 | 10,05 | 007.34F220 | 260,00 |
| | | | | 007.34F3000 | 360,00 |
| 92 S/E/ED NMW/S/E/ED Serie 1/95 92 X/XT | 1095 x 115 x 11,7 270671 (F3) 270672 (F8) | 22/M10 gerade + MWE s.Modell 12 | 10,05 | 007.40F220 | 260,00 |
| | | | | 007.40F3000 | 360,00 |
| 92 | 1095 x 115 x 11,7 Universal alle Typen/all types | 22/M10 +MWE | 10,05 | 007.58F220 | * |
| | | | | 007.58F3000 | 340,00 |
| 107 HY | 1300 x 116 x 8 (208896) 1 Schneide / 1 bevel | 36/M10 | 8,40 | 007.37F220 | * |
| | | | | 007.37F3000 | * |
| 105/107 Masch.-Nr. 301-56873 | 1325 x 120 x 11,95 (208878) | 22/M12 | 12,90 | 007.07F220 | * |
| | | | | 007.07F3000 | * |
| 107 HY/EL ab Masch.-Nr. 57601 110/112 Serie 3/66 | 1390 x 160 x 13,75 | 26/M12 | 21,35 | 007.08F220 | * |
| | | | | 007.08F3000 | * |
| 110/112 EL/ST ab Serie 3/67 115 EL/CE/EMC ab Serie 3/78 X/XT ab Masch.- Nr. 7431001 | 1390 x 160 x 13,75 222061-2 (F2) 245182 (F3) 222063 (F8) Messer kann ab 107 Masch.Nr. 57601 verw. werden. Knife can be used from 107 machine-no. 57601 F-8000 s. sep. Tabelle für Universal-Lochung F-8000 see sep. table for universal perforation | 26/M12 versetzt + MWE s.Modell 3 | 21,35 | 007.24F220 | 480,00 |
| | | | | 007.24F3000 | 695,00 |
| 115 NMW Serie 7/90 115 X/XT Autotrim | 1390 x 160 x 13,75 256491 (F2) 256492 (F3) 256493 (F8) F-8000 s. sep. Tabelle für Universal-Lochung F-8000 see sep. table for universal perforation | 26/M12 gerade + MWE s.Modell 4 | 21,35 | 007.31F220 | 480,00 |
| | | | | 007.31F3000 | 695,00 |
| 115 S/E/ED Serie 5/95 | 1390 x 160 x 13,75 274921 (F3) 274922 (F8) F-8000 s. sep. Tabelle für Universal-Lochung F-8000 see sep. table for universal perforation | 39/M12 (3 Reihen) 4/M5, +MWE s.Modell 14 | 21,25 | 007.41F220 | 510,00 |
| | | | | 007.41F3000 | 695,00 |
| 115 | 1390 x 160 x 13,75 Universal alle Typen/all types | 65/M12 4/M5, +MWE | 21,00 | 007.57F3000 | 670,00 |
| 132 HY Masch.-Nr. 4101 – 57933 | 1525 x 160 x 13,75 (208881) | 22/M12 | 23,30 | 007.11F220 | * |
| | | | | 007.11F3000 | * |
| 137 EL/EMC | 1605 x 160 x 13,75 231126-7 (F2) 245198 (F3) 241350 (F8) F-8000 s. sep. Tabelle für Universal-Lochung F-8000 see sep. table for universal perforation | 30/M12 versetzt + MWE s.Modell 5 | 24,50 | 007.27F220 | 560,00 |
| | | | | 007.27F3000 | 835,00 |

| Maschinen-Typ Type/Type/Tipo | Abmessungen in mm Size/Dimension/Tamaño | Löcher/Holes Trous/Huecos | △ kg | FASSCO-Id. Qualität/Quality/Calid. | €/Stück Pce./Pce./Pza. |
|--|---|---|---------|---------------------------------------|---------------------------|
| 137 NMW Serie 6/90 137 X/XT Autotrim | 1605 x 160 x 13,75 256495 (F3) 256496 (F8) F-8000 s. sep. Tabelle für Universal-Lochung F-8000 see sep. table for universal perforation | 30/M12 gerade + MWE s.Modell 6 | 24,50 | 007.32F220 | 560,00 |
| | | | | 007.32F3000 | 835,00 |
| 137 S/E/ED Serie 4/95 | 1605 x 160 x 13,75 274923 (F3) 274924 (F8) F-8000 s. sep. Tabelle für Universal-Lochung F-8000 see sep. table for universal perforation | 45/M12 (3 Reihen) 4/M5, +MWE s.Modell 15 | 24,35 | 007.42F220 | 590,00 |
| | | | | 007.42F3000 | 835,00 |
| 137 | 1610 x 160 x 13,75 Universal alle Typen/all types | 75/M12 4/M5, +MWE | 24,30 | 007.70F3000 | 810,00 |
| 145 HY | 1660 x 160 x 13,75 | 32/M12 | 25,40 | 007.19F220 | * |
| | | | | 007.19F3000 | * |
| 145 HY Masch.-Nr. 57934 – 58973 | 1680 x 160 x 13,75 208884 (F3) 208885 (F8) | 32/M12 | 25,65 | 007.12F220 | * |
| | | | | 007.12F3000 | * |
| 145 HY ab Masch.-Nr. 58974 | 1680 x 160 x 13,75 | 32/M12 | 25,65 | 007.20F220 | * |
| | | | | 007.20F3000 | * |
| 145 HY | 1700 x 116 x 8 1 Schneide / 1 bevel | 48/M10 | 10,95 | 007.38F220 | * |
| | | | | 007.38F3000 | * |
| 150 HY | 1720 x 160 x 13,75 | 32/M12 | 26,30 | 007.13F220 | * |
| | | | | 007.13F3000 | * |
| 150 EL Serie 1/70 | 1735 x 160 x 13,75 206672 (F3) 206686 (F8) | 32/M12 | 26,55 | 007.14F220 | * |
| | | | | 007.14F3000 | * |
| 145/150 HY 150 ST/EL 150/155 EL CE/CS/EMC | 1785 x 160 x 13,75 221903-4 (F2) 245174 (F3) 222060 (F8) Messer kann ab 145 Masch.Nr.58974 verw. werden. Knife can be used from 145 machine-no. 58974 F-8000 s. sep. Tabelle für Universal-Lochung F-8000 see sep. table for universal perforation | 32/M12 versetzt + MWE s.Modell 7 | 27,30 | 007.25F220 | 640,00 |
| | | | | 007.25F3000 | 985,00 |
| 155 NMW Serie 8/90 155 X/XT Autotrim | 1785 x 160 x 13,75 256498 (F3) 256499 (F8) F-8000 s. sep. Tabelle für Universal-Lochung F-8000 see sep. table for universal perforation | 32/M12 gerade + MWE s.Modell 8 | 27,30 | 007.33F220 | 640,00 |
| | | | | 007.33F3000 | 985,00 |
| 155 S/E/ED Serie 95 | 1785 x 160 x 13,75 274925 (F3) 274926 (F8) F-8000 s. sep. Tabelle für Universal-Lochung F-8000 see sep. table for universal perforation | 48/M12 (3 Reihen) 4/M5, +MWE s.Modell 17 | 27,20 | 007.43F220 | 660,00 |
| | | | | 007.43F3000 | 985,00 |
| 155 | 1790 x 160 x 13,75 Universal alle Typen/all types | 80/M12 4/M5, +MWE | 27,00 | 007.72F3000 | 970,00 |

POLAR



| Maschinen-Typ Type/Type/Tipo | Abmessungen in mm Size/Dimension/Tamaño | Löcher/Holes Trous/Huecos | △ kg | FASSCO-Id. Qualität/Quality/Calid. | €/Stück Pce./Pce./Pza. |
|---------------------------------|---|--|---------|---------------------------------------|---------------------------|
| 176 Serie 6/94 AMW | 1995 x 160 x 13,75 272451 (F3) 272452 (F8) F-8000 s. sep. Tabelle für Universal-Lochung F-8000 see sep. table for universal perforation | 36/M12 versetzt + MWE s.Modell 9 | 30,50 | 007.45F220 | 690,00 |
| | | | | 007.45F3000 | 1.045,00 |
| 176 EMC NMW 176 X/XT | 1995 x 160 x 13,75 259276 (F3) 279275 (F8) F-8000 s. sep. Tabelle für Universal-Lochung F-8000 see sep. table for universal perforation | 36/M12 gerade + MWE s.Modell 10 | 30,50 | 007.35F220 | 690,00 |
| | | | | 007.35F3000 | 1.045,00 |
| 176 S/E/ED Serie 95 | 1995 x 160 x 13,75 274927 (F3) 274928 (F8) F-8000 s. sep. Tabelle für Universal-Lochung F-8000 see sep. table for universal perforation | 54/M12 (3 Reihen) 4/M5 + MWE s.Modell 19 | 30,35 | 007.44F220 | 720,00 |
| | | | | 007.44F3000 | 1.045,00 |
| 176 | 2000 x 160 x 13,75 Universal alle Typen/all types | 90/M12 4/M5 + MWE | 30,00 | 007.73F3000 | 1.030,00 |

HARTMETALL – TUNGSTEN CARBIDE (TCT)– CARBURE – METAL DURO

Universal-Lochung für alle Typen - mit altem und neuem Messerwechsel
Universal perforation for all types - incl. old and new quick change

| Maschinen-Typ Type/Type/Tipo | Abmessungen in mm Size/Dimension/Tamaño | Löcher/Holes Trous/Huecos | △ kg | FASSCO-Id. Qualität/Quality/Calid. | €/Stück Pce./Pce./Pza. |
|---------------------------------|--|------------------------------|---------|---------------------------------------|---------------------------|
| 115 107/110/112 | 1390 x 160 x 13,75 420232 | 26/M12 + MWE | 21,35 | 007.61F8000 | * |
| | | | | 007.61F8020 | * |
| | | | | 007.61F8040 | * |
| 137 | 1605 x 160 x 13,75 439003 | 30/M12 + MWE | 24,50 | 007.54F8000 | * |
| | | | | 007.54F8020 | * |
| | | | | 007.54F8040 | * |
| 155 | 1785 x 160 x 13,75 457500 | 32/M12 + MWE | 27,30 | 007.55F8000 | * |
| | | | | 007.55F8020 | * |
| | | | | 007.55F8040 | * |
| 176 | 1995 x 160 x 13,75 457509 | 36/M12 + MWE | 30,50 | 007.56F8000 | * |
| | | | | 007.56F8020 | * |
| | | | | 007.56F8040 | * |

PRESTO



| Maschinen-Typ Type/Type/Tipo | Abmessungen in mm Size/Dimension/Tamaño | Löcher/Holes Trous/Huecos | △ kg | FASSCO-Id. Qualität/Quality/Calid. | €/Stück Pce./Pce./Pza. |
|---------------------------------|--|------------------------------|---------|---------------------------------------|---------------------------|
| 82 | 1000 x 110 x 10 | 7/M10 | 7,65 | 060.01F220 | * |
| | | | | 060.01F3000 | * |
| 82 neu | 1000 x 110 x 10 | 24/M10 | 7,55 | 060.02F220 | * |
| | | | | 060.02F3000 | * |

PRINTECH

| Maschinen-Typ Type/Type/Tipo | Abmessungen in mm Size/Dimension/Tamaño | Löcher/Holes Trous/Huecos | △ kg | FASSCO-Id. Qualität/Quality/Calid. | €/Stück Pce./Pce./Pza. |
|---------------------------------|--|------------------------------|---------|---------------------------------------|---------------------------|
| 780 30/31" | 960 x 127 x 12,7 | 16/M12 4/M6 +MWE | 10,55 | 148.03F220 | * |
| | | | | 148.03F3000 | * |
| 920 36" | 1100 x 127 x 12,7 (SQZ92.01-16) | 18/M12 4/M6 +MWE | 12,30 | 148.01F220 | * |
| | | | | 148.01F3000 | * |
| 115 45" | 1390 x 160 x 13,75 (SQZ115.01-12) | 24/M12 4/M6 +MWE | 21,35 | 148.02F220 | * |
| | | | | 148.02F3000 | * |
| 137 54" | 1605 x 160 x 13,75 | 30/M12 4/M6 +MWE | 24,50 | 148.04F220 | * |
| | | | | 148.04F3000 | * |

PRISM

| Maschinen-Typ Type/Type/Tipo | Abmessungen in mm Size/Dimension/Tamaño | Löcher/Holes Trous/Huecos | △ kg | FASSCO-Id. Qualität/Quality/Calid. | €/Stück Pce./Pce./Pza. |
|---------------------------------|--|------------------------------|---------|---------------------------------------|---------------------------|
| P 78 30.75" | 970 x 127 x 12,7 | 16/M12 +MWE | 10,80 | 013.06F220 | * |
| | | | | 013.06F3000 | * |
| P 92 36" | 1080 x 127 x 12,7 | 18/M12 +MWE | 12,05 | 013.02F220 | * |
| | | | | 013.02F3000 | * |
| P 115 45" | 1390 x 160 x 12,7 | 22/M12 +MWE | 19,60 | 013.03F220 | * |
| | | | | 013.03F3000 | * |
| P 137 54" | 1605 x 160 x 12,7 | 26/M12 +MWE | 22,65 | 013.04F220 | * |
| | | | | 013.04F3000 | * |

Bei Auftragserteilung aller PRISM-Typen bitte Zeichnung vergleichen.
When placing orders for all PRISM -types please check drawings.

PROTECK

| Maschinen-Typ Type/Type/Tipo | Abmessungen in mm Size/Dimension/Tamaño | Löcher/Holes Trous/Huecos | △ kg | FASSCO-Id. Qualität/Quality/Calid. | €/Stück Pce./Pce./Pza. |
|---------------------------------|--|------------------------------|---------|---------------------------------------|---------------------------|
| CM 920 | 1220 x 130 x 12,7 | 28/M12 6/M6 | 14,10 | 152.03F220 | * |
| | | | | 152.03F3000 | * |
| XC 116 | 1388 x 158 x 13,7 | 26/M12 +MWE | 20,90 | 152.01F220 | * |
| | | | | 152.01F3000 | * |
| XC 137 | 1564 x 158 x 13,7 | 30/M12 +MWE | 23,40 | 152.02F220 | * |
| | | | | 152.02F3000 | * |

Bei Auftragserteilung aller PROTECK-Typen bitte Zeichnung vergleichen.
When placing orders for all PROTECK -types please check drawings.

PURLUX-EUROPA

(PAPYRUS)



| Maschinen-Type Type/Type/Tipo | Abmessungen in mm Size/Dimension/Tamaño | Löcher/Holes Trous/Huecos | kg | FASSCO-Id. Qualität/Quality/Calid. | €/Stück Pce./Pce./Pza. |
|----------------------------------|--|------------------------------|------|---------------------------------------|---------------------------|
| EUROPA | Vordermesser, oben QS8A-3-18 480 x 140/77/65 x 8 | 6/M8 | 1,97 | 099.90/001F236 | * |
| | Seitenmesser, oben links QS8A-3-46 335 x 64/54 x 8 | 8/M8 | 1,08 | 099.90/002F236 | * |
| | Seitenmesser, oben rechts QS8A-3-4 335 x 64/54 x 8 | 8/M8 | 1,08 | 099.90/003F236 | * |
| | Vordermesser, unten QS8A-3-19 480 x 40 x 16/12 | 6 zyl.vers. | 1,92 | 099.90/101F236 | * |
| | Seitenmesser, unten links QS8A-3-47 350 x 40 x 16/12 | 4 zyl.vers. | 1,40 | 099.90/102F236 | * |
| | Seitenmesser, unten rechts QS8A-3-3 350 x 40 x 16/12 | 4 zyl.vers. | 1,40 | 099.90/103F236 | * |
| €/Satz/Set/Jeu/Juego | | | | | |
| EUROPA | Satz Obermesser Set Upper knives | = 3 Messer = 3 knives | 4,13 | 099.90/300F236 | * |
| | Satz Untermesser Set Bottom knives | = 3 Messer = 3 knives | 4,72 | 099.90/303F236 | * |

| Maschinen-Type Type/Type/Tipo | Abmessungen in mm Size/Dimension/Tamaño | Löcher/Holes Trous/Huecos | kg | FASSCO-Id. Qualität/Quality/Calid. | €/Stück Pce./Pce./Pza. |
|---|---|------------------------------------|----------------|---------------------------------------|---------------------------|
| NOVA 10 | Vordermesser, oben QSD10-4-30 550 x 65 x 8 | 8/M8 | 1,85 | 099.91/001F236 | * |
| | | 2/9 Ø 2/M6 | | 099.91/001F3000 | * |
| | Seitenmesser, oben links QSD10-4-94 320 x 65 x 8 | 6/M8 | 1,10 | 099.91/023F236 | * |
| | | 2/9 Ø 2/M6 | | 099.91/023F3000 | * |
| | Seitenmesser, oben rechts QSD10-4-94 320 x 65 x 8 | 6/M6 | 1,10 | 099.91/023F236 | * |
| | | 2/9 Ø 2/M6 | | 099.91/023F3000 | * |
| | Vordermesser, unten QSD10-4-29 550 x 40 x 15 | 8 zyl.vers. Langlöcher 2/9 Ø | 2,05 | 099.91/101F236 | * |
| Seitenmesser, unten links QSD-4-119 380 x 32 x 15/13,8 | 5 zyl.vers. Langlöcher 2/9 Ø | 1,05 | 099.91/123F236 | * | |
| Seitenmesser, unten rechts QSD-4-119 380 x 32 x 15/13,8 | 5 zyl.vers. Langlöcher 2/9 Ø | 1,05 | 099.91/123F236 | * | |
| €/Satz/Set/Jeu/Juego | | | | | |
| NOVA 10 | Satz Obermesser Set Upper knives | = 3 Messer = 3 knives | 4,05 | 099.91/300F236 | * |
| | Satz Obermesser Set Upper knives | = 3 Messer = 3 knives | 4,05 | 099.91/300F3000 | * |
| | Satz Untermesser Set Bottom knives | = 3 Messer = 3 knives | 4,15 | 099.91/303F236 | * |



PURLUX-EUROPA

(PAPYRUS)

| Maschinen-Type Type/Type/Tipo | Abmessungen in mm Size/Dimension/Tamaño | Löcher/Holes Trous/Huecos | ⚖️ kg | FASSCO-Id. Qualität/Quality/Calid. | €/Stück Pce./Pce./Pza. |
|--|--|------------------------------|----------|---------------------------------------|---------------------------|
| EUROPA Stanzen Fase 90° Punch Cut Bevel 90° | Obermesser 360 x 142/74/54 x 4 | 5 Langlöcher | 0,72 | 099.60/004F236 | * |
| | Obermesser 360 x 142/74/54 x 5 | 5 Langlöcher | 0,90 | 099.60/005F236 | * |
| | Obermesser QS8A-3-30 360 x 142/74/54 x 6 | 5 Langlöcher | 1,10 | 099.60/006F236 | * |
| | Obermesser 360 x 142/74/54 x 8 | 5 Langlöcher | 1,45 | 099.60/008F236 | * |
| | Obermesser 360 x 142/74/54 x 10 | 5 Langlöcher | 1,83 | 099.60/010F236 | * |
| | Untermesser, links QS8A-3-50 360 x 48,5 x 9,0/7,0 | 5/M8 | 0,85 | 099.61/123F236 | * |
| | Untermesser, rechts QS8A-3-50 360 x 48,5 x 9,0/7,0 | 5/M8 | 0,85 | 099.61/123F236 | * |

| Maschinen-Type Type/Type/Tipo | Abmessungen in mm Size/Dimension/Tamaño | Löcher/Holes Trous/Huecos | ⚖️ kg | FASSCO-Id. Qualität/Quality/Calid. | €/Stück Pce./Pce./Pza. |
|--|--|------------------------------|----------|---------------------------------------|---------------------------|
| EUROPA Stanzen V-Fase Punch Cut V-Shape | Obermesser 360 x 142/74/54 x 4 | 5 Langlöcher | 0,70 | 099.60/204F236 | * |
| | Obermesser 360 x 142/74/54 x 5 | 5 Langlöcher | 0,87 | 099.60/205F236 | * |
| | Obermesser 360 x 142/74/54 x 6 | 5 Langlöcher | 1,03 | 099.60/206F236 | * |
| | Obermesser 360 x 142/74/54 x 8 | 5 Langlöcher | 1,38 | 099.60/208F236 | * |
| | Obermesser 360 x 142/74/54 x 10 | 5 Langlöcher | 1,75 | 099.60/210F236 | * |

| Maschinen-Type Type/Type/Tipo | Abmessungen in mm Size/Dimension/Tamaño | Löcher/Holes Trous/Huecos | ⚖️ kg | FASSCO-Id. Qualität/Quality/Calid. | €/Stück Pce./Pce./Pza. |
|--|---|------------------------------------|----------|---------------------------------------|---------------------------|
| NOVA 10 Stanzen Punch cut | Obermesser QSD10-4-87 350 x 83,5/60,5 x 6 | 5 + 2 Langlö. 5/ 7-3 2/M6 | 1,10 | 099.62/006F236 | * |
| | Untermesser, links QSD-4-122 360 x 32 x 15 | 4 zyl.vers. Langlöcher 2/9 Ø | 1,08 | 099.63/123F236 | * |
| | Untermesser, rechts QSD-4-122 360 x 32 x 15 | 4 zyl.vers. Langlöcher 2/9 Ø | 1,08 | 099.63/123F236 | * |

**N
O
P
R**

PURPLE MAGNA

| Maschinen-Type Type/Type/Tipo | Abmessungen in mm Size/Dimension/Tamaño | Löcher/Holes Trous/Huecos | △ kg | FASSCO-Id. Qualität/Quality/Calid. | €/Stück Pce./Pce./Pza. |
|----------------------------------|--|------------------------------|---------|---------------------------------------|---------------------------|
| QS-70 | Vordermesser 560 x 82 x 12 | 12/M10 | 3,40 | 143.91/001F3000 | * |
| | Seitenmesser, links 370 x 82 x 14 | 8/M10 | 2,45 | 143.91/023F3000 | * |
| | Seitenmesser, rechts 370 x 82 x 14 | 8/M10 | 2,45 | 143.91/023F3000 | * |
| €/Satz/Set/Jeu/Juego | | | | | |
| QS-70 | kompletter Satz complete set | = 3 Messer = 3 knives | 8,30 | 143.91/300F3000 | * |

| Maschinen-Type Type/Type/Tipo | Abmessungen in mm Size/Dimension/Tamaño | Löcher/Holes Trous/Huecos | △ kg | FASSCO-Id. Qualität/Quality/Calid. | €/Stück Pce./Pce./Pza. |
|----------------------------------|--|------------------------------|---------|---------------------------------------|---------------------------|
| QS-80 | Vordermesser 560 x 110 x 10 | 14/M10 | 4,00 | 143.90/001F220 | * |
| | | | | 143.90/001F3000 | * |
| | Seitenmesser, links 423 x 110 x 10 | 12/M10 | 2,95 | 143.90/023F220 | * |
| | | | | 143.90/023F3000 | * |
| | Seitenmesser, rechts 423 x 110 x 10 | 12/M10 | 2,95 | 143.90/023F220 | * |
| | | | | 143.90/023F3000 | * |
| €/Satz/Set/Jeu/Juego | | | | | |
| QS-80 | kompletter Satz complete set | = 3 Messer = 3 knives | 9,90 | 143.90/300F220 | * |
| | | | | 143.90/300F3000 | * |

| Maschinen-Type Type/Type/Tipo | Abmessungen in mm Size/Dimension/Tamaño | Löcher/Holes Trous/Huecos | △ kg | FASSCO-Id. Qualität/Quality/Calid. | €/Stück Pce./Pce./Pza. |
|----------------------------------|--|------------------------------|---------|---------------------------------------|---------------------------|
| ZK320A | Obermesser 400 x 100 x 12 | 5/M10 | 2,85 | 143.89/001F3000 | * |
| | Untermesser 400 x 55 x 20 | 3/M10 2/9Ø | 3,30 | 143.89/101F236 | * |

RADOR

| Maschinen-Type Type/Type/Tipo | Abmessungen in mm Size/Dimension/Tamaño | Löcher/Holes Trous/Huecos | △ kg | FASSCO-Id. Qualität/Quality/Calid. | €/Stück Pce./Pce./Pza. |
|----------------------------------|--|------------------------------|---------|---------------------------------------|---------------------------|
| Rador-Simplex | 980 x 107 x 10 | 6/M10 | 7,25 | 042.01F220 | * |
| | | | | 042.01F3000 | * |
| Auto-Rador | 1040 x 115 x 10 | 9/M12 oder 1/2"W | 8,25 | 042.02F220 | * |
| | | | | 042.02F3000 | * |

RAPIER MATIC

| Maschinen-Type Type/Type/Tipo | Abmessungen in mm Size/Dimension/Tamaño | Löcher/Holes Trous/Huecos | △ kg | FASSCO-Id. Qualität/Quality/Calid. | €/Stück Pce./Pce./Pza. |
|----------------------------------|--|------------------------------|---------|---------------------------------------|---------------------------|
| RP 67 | 795 x 90 x 9 | 6/M10 | 4,45 | 029.10F220 | * |
| | | | | 029.10F3000 | * |
| RP 72 | 845 x 90 x 9 | 6/M10 | 4,80 | 029.11F220 | * |
| | | | | 029.11F3000 | * |
| RP 78 | 900 x 90 x 9 | 6/M10 | 5,04 | 029.12F220 | * |
| | | | | 029.12F3000 | * |

RC SYSTEMS

| Maschinen-Type Type/Type/Tipo | Abmessungen in mm Size/Dimension/Tamaño | Löcher/Holes Trous/Huecos | △ kg | FASSCO-Id. Qualität/Quality/Calid. | €/Stück Pce./Pce./Pza. |
|----------------------------------|--|------------------------------|---------|---------------------------------------|---------------------------|
| RC 464 M | 525 x 50 x 6 | 7/M6 | 0,99 | 154.01F220 | * |



ROBUST (HEUSER)

| Maschinen-Type Type/Type/Tipo | Abmessungen in mm Size/Dimension/Tamaño | Löcher/Holes Trous/Huecos | △ kg | FASSCO-Id. Qualität/Quality/Calid. | €/Stück Pce./Pce./Pza. |
|----------------------------------|--|------------------------------|---------|---------------------------------------|---------------------------|
| 45 | 568 x 80 x 7 | 5/M8 | 2,20 | 054.01F220 | * |
| | | | | 054.01F3000 | * |
| 83 | 1035 x 90 x 9 | 8/M10 | 5,70 | 002.05F220 | * |
| | | | | 002.05F3000 | * |

weitere Messertypen auf Anfrage



ROSBACK

(CAMCO)

| Maschinen-Typ Type/Type/Tipo | Abmessungen in mm Size/Dimension/Tamaño | Löcher/Holes Trous/Huecos | △ kg | FASSCO-Id. Qualität/Quality/Calid. | €/Stück Pce./Pce./Pza. |
|--|---|------------------------------|----------------|---------------------------------------|---------------------------|
| CB 250/251 Big 3 Reliant 318/203 | Vordermesser, oben 412,75 x 76,2 x 12,6 16.1/4" x 3" x .496" (250-78) | 5 3/8" 2 1/4" | 2,40 | 053.90/001F236 | * |
| | | | | 053.90/001F3000 | * |
| | Seitenmesser, oben links 317,50 x 76,2 x 12,6 12.1/2" x 3" x .496" (250-77) | 5 3/8" 2 1/4" | 1,80 | 053.90/023F236 | * |
| | | | | 053.90/023F3000 | * |
| | Seitenmesser, oben rechts 317,50 x 76,2 x 12,6 12.1/2" x 3" x .496" (250-77) | 5 3/8" 2 1/4" | 1,80 | 053.90/023F236 | * |
| | | | | 053.90/023F3000 | * |
| Vordermesser, unten 431,80 x 38,1 x 12,7 17" x 1.1/2" x .500" (250-76) | 4 vers.Lö. | 1,45 | 053.90/101F236 | * | |
| Seitenmesser, unten links 339,73 x 38,1 x 12,7 13.3/8" x 1.1/2" x .500" (250-75) | 4 vers.Lö. | 1,10 | 053.90/123F236 | * | |
| Seitenmesser, unten rechts 339,73 x 38,1 x 12,7 13.3/8" x 1.1/2" x .500" (250-75) | 4 vers.Lö. | 1,10 | 053.90/123F236 | * | |
| €/Satz/Set/Jeu/Juego | | | | | |
| CB 250/251 Big 3 Reliant 318/203 | Satz Obermesser Set Upper knives | = 3 Messer = 3 knives | 6,00 | 053.90/300F236 | * |
| | Satz Obermesser Set Upper knives | = 3 Messer = 3 knives | 6,00 | 053.90/300F3000 | * |
| | Satz Untermesser Set Bottom knives | = 3 Messer = 3 knives | 3,65 | 053.90/303F236 | * |

* Preis auf Anfrage / Price on request

R.P.M.



| Maschinen-Type Type/Type/Tipo | Abmessungen in mm Size/Dimension/Tamaño | Löcher/Holes Trous/Huecos | △ kg | FASSCO-Id. Qualität/Quality/Calid. | €/Stück Pce./Pce./Pza. |
|----------------------------------|--|------------------------------|---------|---------------------------------------|---------------------------|
| RPM 80 RPM 82 | 960 x 107 x 10 | 6/M10 | 7,10 | 009.09F220 | * |
| | | | | 009.09F3000 | * |
| RPM 82 | 960 x 107 x 10 | 9/M10 | 7,05 | 009.10F220 | * |
| | | | | 009.10F3000 | * |
| RSS 105 | 1225 x 155 x 12,8 (KSS 189) | 18/M12 | 16,80 | 009.01F220 | * |
| | | | | 009.01F3000 | * |
| RSS 107 Rapid | 1245 x 155 x 13,8 | 20/M12 | 18,40 | 009.02F220 | * |
| | | | | 009.02F3000 | * |
| RPM 105 RPM 107 | 1300 x 155 x 12,8 | 20/M12 | 17,80 | 009.03F220 | * |
| | | | | 009.03F3000 | * |
| RSS 115 | 1325 x 155 x 12,8 | 20/M12 | 18,20 | 009.04F220 | * |
| | | | | 009.04F3000 | * |
| RSS 130 | 1475 x 155 x 12,8 (RSS 130/189) | 22/M12 | 20,30 | 009.05F220 | * |
| | | | | 009.05F3000 | * |
| RPM 130 RPM 132 | 1550 x 155 x 12,8 (130-5-01) | 24/M12 | 21,30 | 009.06F220 | * |
| | | | | 009.06F3000 | * |
| RPM 153 | 1745 x 155 x 14,8 (153-5-01) | 30/M12 | 27,80 | 009.07F220 | * |
| | | | | 009.07F3000 | * |
| RPM 165 | 1875 x 155 x 14,8 (165-5-01) | 30/M12 | 29,85 | 009.08F220 | * |
| | | | | 009.08F3000 | * |

SAITO



| Maschinen-Type Type/Type/Tipo | Abmessungen in mm Size/Dimension/Tamaño | Löcher/Holes Trous/Huecos | △ kg | FASSCO-Id. Qualität/Quality/Calid. | €/Stück Pce./Pce./Pza. |
|----------------------------------|--|------------------------------|---------|---------------------------------------|---------------------------|
| HC-71 alt | 850 x 125 x 9,3 | 7/M10 | 6,80 | 087.02F220 | * |
| | | | | 087.02F3000 | * |
| HC-71 neu | 850 x 130 x 9,5 | 14/M10 | 7,25 | 087.10F220 | * |
| | | | | 087.10F3000 | * |
| KS-87 alt | 1070 x 125 x 9,3 | 9 7/16"W | 8,60 | 087.03F220 | * |
| | | | | 087.03F3000 | * |
| KS-87 neu | 1070 x 130 x 9,5 | 18 7/16"W | 9,10 | 087.11F220 | * |
| | | | | 087.11F3000 | * |
| HC-87 alt | 1070 x 125 x 10,9 | 9 7/16"W | 10,10 | 087.04F220 | * |
| | | | | 087.04F3000 | * |
| HC-87 neu | 1070 x 130 x 11,1 | 18 7/16"W | 10,70 | 087.12F220 | * |
| | | | | 087.12F3000 | * |
| KS alt | 1200 x 135 x 10,9 | 10 7/16"W | 12,25 | 087.05F220 | * |
| | | | | 087.05F3000 | * |
| KS neu | 1200 x 140 x 11,1 | 20 7/16"W | 12,90 | 087.13F220 | * |
| | | | | 087.13F3000 | * |

Bei Auftragserteilung aller SAITO-Typen bitte Zeichnung vergleichen.
When placing orders for SAITO -types please check drawings.



SAITO

| Maschinen-Type Type/Type/Tipo | Abmessungen in mm Size/Dimension/Tamaño | Löcher/Holes Trous/Huecos | kg | FASSCO-Id. Qualität/Quality/Calid. | €/Stück Pce./Pce./Pza. |
|----------------------------------|--|------------------------------|-------|---------------------------------------|---------------------------|
| KS-102 alt | 1200 x 135 x 10,9 | 10 7/16"W | 12,20 | 087.06F220 | * |
| | | | | 087.06F3000 | * |
| KS-102 neu | 1200 x 140 x 11,1 | 20 7/16"W | 12,85 | 087.14F220 | * |
| | | | | 087.14F3000 | * |
| H-116 alt | 1350 x 145 x 12,5 | 11 7/16"W | 16,95 | 087.07F220 | * |
| | | | | 087.07F3000 | * |
| H-116 neu | 1350 x 150 x 12,7 | 22 7/16"W | 17,80 | 087.15F220 | * |
| | | | | 087.15F3000 | * |
| H-120 | 1370 x 152,4 x 12,7 | 11 7/16"W | 18,10 | 087.01F220 | * |
| | | | | 087.01F3000 | * |
| H-132 HC/SC-132 | 1530 x 145 x 12,5 | 12 7/16"W | 19,20 | 087.08F220 | * |
| | | | | 087.08F3000 | * |
| H-132 HC/SC-132 | 1530 x 150 x 12,7 | 24 7/16"W | 20,20 | 087.16F220 | * |
| | | | | 087.16F3000 | * |
| | 1905 x 152,4 x 12,7 | 30 7/16"W | 25,50 | 087.09F220 | * |
| | | | | 087.09F3000 | * |

Bei Auftragserteilung aller SAITO-Typen bitte Zeichnung vergleichen.
When placing orders for SAITO -types please check drawings.



SAROGLIA

| Maschinen-Type Type/Type/Tipo | Abmessungen in mm Size/Dimension/Tamaño | Löcher/Holes Trous/Huecos | kg | FASSCO-Id. Qualität/Quality/Calid. | €/Stück Pce./Pce./Pza. |
|----------------------------------|--|------------------------------|-------|---------------------------------------|---------------------------|
| 72 Tornado | 912 x 115 x 10 | 24/M14x1,5 | 7,25 | 033.01F220 | * |
| | | | | 033.01F3000 | * |
| TC 83 | 1030 x 115 x 10 | 24/M14x1,5 | 8,20 | 033.02F220 | * |
| | | | | 033.02F3000 | * |
| 105 *) | 1280 x 125 x 10 | | 11,10 | 033.03F220 | * |
| | | | | 033.03F3000 | * |
| 106 *) Caesar | 1275 x 125 x 10 | 33/M14x1,5 | 11,00 | 033.04F220 | * |
| | | | | 033.04F3000 | * |

*) Für diese SAROGLIA-Typen ist eine Zeichnung erforderlich.

*) For these SAROGLIA-types a drawing is required.

SCHIMANEK

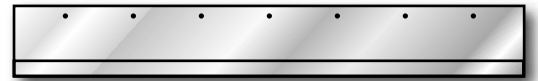

| Maschinen-Type Type/Type/Tipo | Abmessungen in mm Size/Dimension/Tamaño | Löcher/Holes Trous/Huecos | ⚖️ kg | FASSCO-Id. Qualität/Quality/Calid. | €/Stück Pce./Pce./Pza. |
|----------------------------------|--|------------------------------|----------|---------------------------------------|---------------------------|
| HS 46 | 600 x 60 x 5 | 6 vers. | 1,25 | 025.01F220 | * |
| | | | | 025.01F3000 | * |
| SH 46 | 650 x 60 x 7 | 6/M6 | 1,88 | 025.13F220 | * |
| | | | | 025.13F3000 | * |
| SH 52 | 725 x 75 x 8 | 5/M8 | 2,98 | 025.14F220 | * |
| | | | | 025.14F3000 | * |
| HS 64 HS 66 | 800 x 75 x 6 | 5 vers. | 2,45 | 025.02F220 | * |
| | | | | 025.02F3000 | * |
| SH 66 | 840 x 75 x 8 | 6/M8 | 3,50 | 025.12F220 | * |
| | | | | 025.12F3000 | * |
| SH 66 SSH 66 | 860 x 75 x 8 | 6/M8 | 3,55 | 025.03F220 | * |
| | | | | 025.03F3000 | * |
| SSH 72 | 950 x 115 x 9 | 7/M10 | 6,80 | 025.10F220 | * |
| | | | | 025.10F3000 | * |
| SH 80 | 970 x 115 x 9 | 8/M10 | 6,95 | 025.04F220 | * |
| | | | | 025.04F3000 | * |
| SH 81 | 1000 x 115 x 9 | 8/M10 | 7,15 | 025.05F220 | * |
| | | | | 025.05F3000 | * |
| SSH 81 SSH 82 | 1030 x 115 x 9 | 8/M10 | 7,40 | 025.11F220 | * |
| | | | | 025.11F3000 | * |
| SSH 86/87 SSH 92 | 1100 x 115 x 9 | 9/M10 | 7,90 | 025.06F220 | * |
| | | | | 025.06F3000 | * |
| SH 90 | 1180 x 115 x 9 | 9/M10 | 8,45 | 025.07F220 | * |
| | | | | 025.07F3000 | * |
| SSH 106 | 1300 x 140 x 12 | 20/M12 | 15,15 | 025.08F220 | * |
| | | | | 025.08F3000 | * |

Für alle SCHIMANEK-Typen ist ein Muster oder eine Zeichnung erforderlich.
For all SCHIMANEK-types a sample or a drawing is necessary.

SCHIMANEK-UNIVERSAL

(American Projection)

| Maschinen-Type Type/Type/Tipo | Abmessungen in mm Size/Dimension/Tamaño | Löcher/Holes Trous/Huecos |  kg | FASSCO-Id. Qualität/Quality/Calid. | €/Stück Pce./Pce./Pza. |
|----------------------------------|--|------------------------------|---|---------------------------------------|---------------------------|
| 21" | 651 x 90 x 6,9 | 6/M8 | 2,80 | 025.51F220 | * |
| | | | | 025.51F3000 | * |
| 28" | 950 x 110 x 9,98 | 7/M10 | 7,25 | 025.52F220 | * |
| | | | | 025.52F3000 | * |
| 30-1/2" 32-1/2" | 1035 x 115 x 9,98 | 7/M10 | 8,25 | 025.53F220 | * |
| | | | | 025.53F3000 | * |
| 32-1/2" | 1040 x 115 x 9,98 | 7/M10 | 8,30 | 025.60F220 | * |
| | | | | 025.60F3000 | * |
| 33" HS 83 | 1100 x 120 x 9,98 | 8/M10 | 9,15 | 025.54F220 | * |
| | | | | 025.54F3000 | * |
| 35-1/2" SH 90 | 1180 x 115 x 9,98 | 9/M10 | 9,40 | 025.55F220 | * |
| | | | | 025.55F3000 | * |
| 39" HS 99 | 1250 x 125 x 12,68 | 9/M10 | 13,80 | 025.56F220 | * |
| | | | | 025.56F3000 | * |
| 42" HS 107 | 1360 x 140 x 12,68 | 10/M12 | 16,75 | 025.57F220 | * |
| | | | | 025.57F3000 | * |
| 47" SH 120 | 1513 x 140 x 11,98 | 10/M12 | 17,65 | 025.58F220 | * |
| | | | | 025.58F3000 | * |
| 57" SH 145 | 1727 x 140 x 11,98 | 11/M12 | 20,15 | 025.59F220 | * |
| | | | | 025.59F3000 | * |

Für alle SCHIMANEK-Typen ist ein Muster oder eine Zeichnung erforderlich.
For all SCHIMANEK-types a sample or a drawing is necessary.



SCHNEIDER ENGINEERING

KS-Master

| Maschinen-Type Type/Type/Tipo | Abmessungen in mm Size/Dimension/Tamaño | Löcher/Holes Trous/Huecos |  kg | FASSCO-Id. Qualität/Quality/Calid. | €/Stück Pce./Pce./Pza. |
|----------------------------------|--|------------------------------|---|---------------------------------------|---------------------------|
| S 115 | 1390 x 160 x 13,75 | 26/M12 +MWE | 21,35 | 007.24F220 | 480,00 |
| | | | | 007.24F3000 | 695,00 |
| S 137 | 1605 x 160 x 13,75 | 30/M12 +MWE | 24,50 | 007.27F220 | 560,00 |
| | | | | 007.27F3000 | 835,00 |
| S 155 | 1785 x 160 x 13,75 | 32/M12 +MWE | 27,30 | 007.25F220 | 640,00 |
| | | | | 007.25F3000 | 985,00 |
| S 185 | 2080 x 160 x 13,75 | 40/M12 | 31,80 | 088.01F220 | 776,00 |
| | | | | 088.01F3000 | 1.110,00 |
| S 220 | 2430 x 160 x 13,75 | 48/M12 | 37,15 | 088.02F220 | 917,00 |
| | | | | 088.02F3000 | 1.294,00 |
| S 320 | 3430 x 160 x 13,75 | 68/M12 | 52,00 | 088.06F220 | 1.248,00 |
| | | | | 088.06F3000 | 1.759,00 |

SCHNEIDER-SENATOR



| Maschinen-Typ Type/Type/Tipo | Abmessungen in mm Size/Dimension/Tamaño | Löcher/Holes Trous/Huecos | kg | FASSCO-Id. Qualität/Quality/Calid. | €/Stück Pce./Pce./Pza. |
|---|---|------------------------------|-------|---------------------------------------|---------------------------|
| SENATOR 78 E-Line >98 | 884 x 129 x 12,1 | 18/M12 | 9,15 | 010.17F220 | 270,00 |
| | | | | 010.17F3000 | 374,00 |
| SENATOR 76 E-Line >96 | 900 x 100 x 10 | 12/M12 | 6,05 | 004.20F220 | 213,00 |
| | | | | 004.20F3000 | 295,00 |
| SENATOR 76 | 910 x 105 x 9,95 | 12/M10 | 6,55 | 010.14F220 | 204,00 |
| | | | | 010.14F3000 | 290,00 |
| SENATOR 78 E-Line | 935 x 129 x 12,1 (900782360300 F2) (900782360310 F3) (900782360320 F8) | 18/M12 | 10,20 | 010.20F220 | 281,00 |
| | | | | 010.20F3000 | 393,00 |
| KONSUL 78 | 945 x 110 x 8 | 24/M10 | 5,75 | 010.09F220 | * |
| | | | | 010.09F3000 | * |
| SHE 78 | 960 x 107 x 9,7 | 16/M10 | 6,90 | 010.01F220 | * |
| | | | | 010.01F3000 | * |
| SENATOR 78 | 980 x 133 x 9,95 | 24/M10 | 9,00 | 010.02F220 | * |
| | | | | 010.02F3000 | * |
| KONSUL 85/86 SENATOR 85/86 | 990 x 120 x 8 | 24/M10 | 6,55 | 010.11F220 | * |
| | | | | 010.11F3000 | * |
| SENATOR 82 | 1020 x 133 x 9,95 | 24/M10 | 9,35 | 010.03F220 | * |
| | | | | 010.03F3000 | * |
| SENATOR 92H E-Line >99 | 1050 x 129 x 12,1 (900922350300 F2) | 20/M12 | 11,10 | 010.18F220 | 317,00 |
| | | | | 010.18F3000 | 427,00 |
| SENATOR 92 E-Line >96 | 1060 x 125 x 12 | 18/M12 | 11,05 | 030.13F220 | 337,00 |
| | | | | 030.13F3000 | 478,00 |
| SENATOR 92 (alt) | 1090 x 132 x 9,95 | 27/M10 | 10,00 | 010.10F220 | * |
| | | | | 010.10F3000 | * |
| SENATOR 106 110/112 | 1280 x 144 x 9,95 | 33/M12 | 12,80 | 010.04F220 | * |
| | | | | 010.04F3000 | * |
| SENATOR 115 (alt) | 1330 x 144 x 9,95 | 36/M12 | 13,30 | 010.08F220 | * |
| | | | | 010.08F3000 | * |
| SENATOR 115 >11/81 | 1350 x 144 x 9,95 | 36/M12 | 13,40 | 010.13F220 | 384,00 |
| | | | | 010.13F3000 | 566,00 |
| SENATOR 115H S-Line / 115 MST 115 TSC >05/95 | 1360 x 144 x 12,1 (901152350310) 12.20.001 (F2) 12.20.015 (F3) 12.20.016 (F8) | 36/M12 | 16,00 | 010.15F220 | 426,00 |
| | | | | 010.15F3000 | 638,00 |
| SENATOR 115-S 13,75 >01/14 SERVO | 1360 x 149 x 13,75 (901172350311) | 36/M12 | 19,20 | 010.21F220 | * |
| | | | | 010.21F3000 | * |
| SENATOR 132 | 1566 x 144 x 11,95 | 39/M12 | 18,50 | 010.05F220 | 473,00 |
| | | | | 010.05F3000 | 710,00 |



SCHNEIDER-SENATOR

| Maschinen-Typ Type/Type/Tipo | Abmessungen in mm Size/Dimension/Tamaño | Löcher/Holes Trous/Huecos | kg | FASSCO-Id. Qualität/Quality/Calid. | €/Stück Pce./Pce./Pza. |
|---------------------------------|--|------------------------------|-------|---------------------------------------|---------------------------|
| SENATOR 137H S-Line >98 | 1580 x 144 x 12,1 (9003212350110) 14.20.001 (F2) 14.20.015 (F3) 14.20.016 (F8) | 45/M12 | 18,75 | 010.16F220 | * |
| | | | | 010.16F3000 | * |
| SENATOR 155H S-Line >99 | 1760 x 144 x 12,1 (900552350021) 16.20.001 (F2) 16.20.015 (F3) 16.20.016 (F8) | 51/M12 | 19,90 | 010.19F220 | * |
| | | | | 010.19F3000 | * |
| SENATOR 155/157 | 1880 x 149 x 11,95 | 45/M12 | 23,30 | 010.06F220 | 611,00 |
| | | | | 010.06F3000 | 898,00 |
| SENATOR 185 | 2190 x 149 x 11,95 | 54/M12 | 27,05 | 010.07F220 | 741,00 |
| | | | | 010.07F3000 | 1.059,00 |
| SENATOR 260 | 2950 x 149 x 11,95 (901472010440 F3) | 75/M12 | 36,50 | 010.12F220 | 1.012,00 |
| | | | | 010.12F3000 | 1.422,00 |



SEYBOLD

SEYBOLD-DAYTON CUTTER MODELL 10Z + 6Z

| Maschinen-Typ Type/Type/Tipo | Abmessungen in mm Size/Dimension/Tamaño | Löcher/Holes Trous/Huecos | kg | FASSCO-Id. Qualität/Quality/Calid. | €/Stück Pce./Pce./Pza. |
|---------------------------------|---|------------------------------|-------|---------------------------------------|---------------------------|
| 35" | 1168,4 x 127 x 12,6 46" x 5" x .496" (6ZA 278B) | 21 1/2"-12 | 12,90 | 052.01F220 | * |
| | | | | 052.01F3000 | * |
| 40" | 1295,4 x 127 x 12,6 51" x 5" x .496" (6ZB 278B) | 24 1/2"-12 | 14,30 | 052.02F220 | * |
| | | | | 052.02F3000 | * |
| 44" | 1397 x 127 x 12,6 55" x 5" x .496" (6ZC 278B) | 27 1/2"-12 | 15,50 | 052.03F220 | * |
| | | | | 052.03F3000 | * |
| 50" | 1549,4 x 127 x 12,6 61" x 5" x .496" (6ZD 278B) | 30 1/2"-12 | 17,10 | 052.04F220 | * |
| | | | | 052.04F3000 | * |
| 56" | 1701,8 x 127 x 12,6 67" x 5" x .496" (6ZE 278B) | 33 1/2"-12 | 18,80 | 052.05F220 | * |
| | | | | 052.05F3000 | * |
| 64" | 1905 x 127 x 12,6 75" x 5" x .496" (6ZF 278B) | 36 1/2"-12 | 21,10 | 052.06F220 | * |
| | | | | 052.06F3000 | * |
| 67" | 1981,2 x 127 x 12,6 78" x 5" x .496" | 39 1/2"-12 | 21,90 | 052.45F220 | * |
| | | | | 052.45F3000 | * |
| 74" | 2159 x 127 x 12,6 85" x 5" x .496" (6ZG 278B) | 42 1/2"-12 | 23,90 | 052.07F220 | * |
| | | | | 052.07F3000 | * |
| 84" | 2413 x 127 x 12,6 95" x 5" x .496" (6ZH 278B) | 45 1/2"-12 | 26,70 | 052.08F220 | * |
| | | | | 052.08F3000 | * |
| 94" | 2667 x 127 x 12,6 105" x 5" x .496" (15ZJ 278A) | 51 1/2"-12 | 29,50 | 052.09F220 | * |
| | | | | 052.09F3000 | * |

* Preis auf Anfrage / Price on request

SEYBOLD

2Y + 4Y

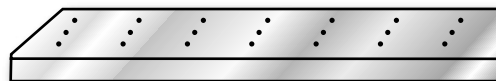

| Maschinen-Type Type/Type/Tipo | Abmessungen in mm Size/Dimension/Tamaño | Löcher/Holes Trous/Huecos | ⚖️ kg | FASSCO-Id. Qualität/Quality/Calid. | €/Stück Pce./Pce./Pza. |
|----------------------------------|--|------------------------------|----------|---------------------------------------|---------------------------|
| 32" | 990,6 x 127 x 12,6 39" x 5" x .496" (2YA 109) | 14 1/2"-12 | 10,90 | 052.20F220 | * |
| | | | | 052.20F3000 | * |
| 34" | 1041,4 x 127 x 12,4 41" x 5" x .489" (4YAA 109B) | 21 1/2"-12 2 Ø7,94 | 11,50 | 052.47F220 | * |
| | | | | 052.47F3000 | * |
| 36" | 1092,2 x 127 x 12,6 43" x 5" x .496" (2YB 109A) | 14 1/2"-12 | 12,10 | 052.21F220 | * |
| | | | | 052.21F3000 | * |

20th CENTURY CUTTER MODELL 4 Z

| Maschinen-Type Type/Type/Tipo | Abmessungen in mm Size/Dimension/Tamaño | Löcher/Holes Trous/Huecos | ⚖️ kg | FASSCO-Id. Qualität/Quality/Calid. | €/Stück Pce./Pce./Pza. |
|----------------------------------|--|------------------------------|----------|---------------------------------------|---------------------------|
| 38" | 1143,0 x 127 x 12,6 45" x 5" x .496" (4ZB 278A) | 16 1/2"-12 | 12,60 | 052.22F220 | * |
| | | | | 052.22F3000 | * |
| 44" | 1295,4 x 127 x 12,6 51" x 5" x .496" (4ZC 278A) | 18 1/2"-12 | 14,30 | 052.23F220 | * |
| | | | | 052.23F3000 | * |
| 50" | 1447,8 x 127 x 12,6 57" x 5" x .496" (4ZD 278A) | 20 1/2"-12 | 16,00 | 052.24F220 | * |
| | | | | 052.24F3000 | * |
| 54" | 1549,4 x 127 x 12,6 61" x 5" x .496" (4ZE 278A) | 20 1/2"-12 | 17,10 | 052.25F220 | * |
| | | | | 052.25F3000 | * |
| 60" | 1701,8 x 127 x 12,6 67" x 5" x .496" (4ZEE 278A) | 22 1/2"-12 | 18,80 | 052.26F220 | * |
| | | | | 052.26F3000 | * |
| 64" | 1803,4 x 127 x 12,6 71" x 5" x .496" (4ZF 278A) | 24 1/2"-12 | 20,00 | 052.27F220 | * |
| | | | | 052.27F3000 | * |
| 74" | 2057,4 x 127 x 12,6 81" x 5" x .496" (4ZG 278A) | 28 1/2"-12 | 22,80 | 052.28F220 | * |
| | | | | 052.28F3000 | * |
| 84" | 2311,4 x 127 x 12,6 91" x 5" x .496" (4ZH 278A) | 30 1/2"-12 | 25,60 | 052.29F220 | * |
| | | | | 052.29F3000 | * |

S



| Maschinen-Type Type/Type/Tipo | Abmessungen in mm Size/Dimension/Tamaño | Löcher/Holes Trous/Huecos | kg | FASSCO-Id. Qualität/Quality/Calid. | €/Stück Pce./Pce./Pza. |
|----------------------------------|--|------------------------------|-------|---------------------------------------|---------------------------|
| 40" 41" | 1346,2 x 127 x 12,6 53" x 5" x .496" (CFB-8) | 24 1/2"-12 | 14,90 | 052.30F220 | * |
| | | | | 052.30F3000 | * |
| 44" | 1447,8 x 127 x 12,6 57" x 5" x .496" (CFC-8) | 27 1/2"-12 | 16,00 | 052.31F220 | * |
| | | | | 052.31F3000 | * |
| 50" | 1600,2 x 127 x 12,6 63" x 5" x .496" (CFD-8) | 30 1/2"-12 | 17,70 | 052.32F220 | * |
| | | | | 052.32F3000 | * |
| 64" 65" | 1974,85 x 127 x 12,6 77.3/4" x 5" x .496" (CFF-8A) | 36 1/2"-12 | 21,80 | 052.33F220 | * |
| | | | | 052.33F3000 | * |
| 84" | 2482,85 x 127 x 12,6 97.3/4" x 5" x .496" (CFH-8A) | 45 1/2"-12 | 27,50 | 052.34F220 | * |
| | | | | 052.34F3000 | * |

SABER – HYDRAULIC CLAMP

| Maschinen-Type Type/Type/Tipo | Abmessungen in mm Size/Dimension/Tamaño | Löcher/Holes Trous/Huecos | kg | FASSCO-Id. Qualität/Quality/Calid. | €/Stück Pce./Pce./Pza. |
|----------------------------------|--|------------------------------|-------|---------------------------------------|---------------------------|
| 40" 41" | 1346,2 x 127 x 12,6 53" x 5" x .496" (CKB-8/CFB-8) | 24 1/2"-12 | 14,90 | 052.30F220 | * |
| | | | | 052.30F3000 | * |
| 47" | 1498,6 x 127 x 12,6 59" x 5" x .496" (CKC-220) | 27 1/2"-12 | 16,60 | 052.36F220 | * |
| | | | | 052.36F3000 | * |
| 54" | 1676,4 x 127 x 12,6 66" x 5" x .496" (CKD-220) | 30 1/2"-12 | 18,50 | 052.37F220 | * |
| | | | | 052.37F3000 | * |
| 58" | 1778 x 127 x 12,6 70" x 5" x .496" (CKE-220) | 33 1/2"-12 | 19,70 | 052.38F220 | * |
| | | | | 052.38F3000 | * |
| 64" 65" | 1974,85 x 127 x 12,6 77.3/4" x 5" x .496" (CFF-8A) | 36 1/2"-12 | 21,80 | 052.33F220 | * |
| | | | | 052.33F3000 | * |

„CJ“ MILL CUTTER ALLHYDRAULIC

| Maschinen-Type Type/Type/Tipo | Abmessungen in mm Size/Dimension/Tamaño | Löcher/Holes Trous/Huecos | kg | FASSCO-Id. Qualität/Quality/Calid. | €/Stück Pce./Pce./Pza. |
|----------------------------------|---|------------------------------|-------|---------------------------------------|---------------------------|
| 64" 65" | 1974,85 x 127 x 12,6 77.3/4" x 5" x .496" (CJK/ CFF-8A) | 36 1/2"-12 | 21,80 | 052.33F220 | * |
| | | | | 052.33F3000 | * |
| 84" 85" | 2482,85 x 127 x 12,6 97.3/4" x 5" x .496" (CJH/ CFH-8A) | 45 1/2"-12 | 27,50 | 052.34F220 | * |
| | | | | 052.34F3000 | * |
| 90" | 2578,1 x 139,7 x 12,6 101.1/2" x 5.5" x .496" (CMH-8) | 51 1/2"-12 | 31,40 | 052.42F220 | * |
| | | | | 052.42F3000 | * |
| 100" | 2838,45 x 127 x 12,6 111.3/4" x 5" x .496" (CJL-8) | 54 1/2"-12 | 31,40 | 052.43F220 | * |
| | | | | 052.43F3000 | * |
| 112" | 3136,9 x 139,7 x 12,6 123.1/2" x 5.5" x .496" (CML-8) | 60 1/2"-12 | 38,30 | 052.44F220 | * |
| | | | | 052.44F3000 | * |

SEYBOLD

DYNA CLAMP 34 CHB

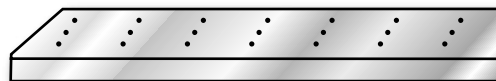

| Maschinen-Type Type/Type/Tipo | Abmessungen in mm Size/Dimension/Tamaño | Löcher/Holes Trous/Huecos | △ kg | FASSCO-Id. Qualität/Quality/Calid. | €/Stück Pce./Pce./Pza. |
|----------------------------------|--|------------------------------|---------|---------------------------------------|---------------------------|
| 34" | 1143 x 127 x 12,6 45" x 5" x .496" (CHB-157) | 21 1/2"-12 | 12,60 | 052.10F220 | * |
| | | | | 052.10F3000 | * |

36" AUTO CLAMP

| Maschinen-Type Type/Type/Tipo | Abmessungen in mm Size/Dimension/Tamaño | Löcher/Holes Trous/Huecos | △ kg | FASSCO-Id. Qualität/Quality/Calid. | €/Stück Pce./Pce./Pza. |
|----------------------------------|--|------------------------------|---------|---------------------------------------|---------------------------|
| 36" | 1168,4 x 127 x 12,6 46" x 5" x .496" (CBA-331) | 24 1/2"-12 | 12,90 | 052.11F220 | * |
| | | | | 052.11F3000 | * |

MAGNETRONIC CUTTER

| Maschinen-Type Type/Type/Tipo | Abmessungen in mm Size/Dimension/Tamaño | Löcher/Holes Trous/Huecos | △ kg | FASSCO-Id. Qualität/Quality/Calid. | €/Stück Pce./Pce./Pza. |
|----------------------------------|---|------------------------------|---------|---------------------------------------|---------------------------|
| 46" | 1447,8 x 140 x 12,6 57" x 5.512" x .496" (CLC 25) | 27/M12x1,5 | 17,50 | 052.46F220 | * |
| | | | | 052.46F3000 | * |

HOLYOKE

| Maschinen-Type Type/Type/Tipo | Abmessungen in mm Size/Dimension/Tamaño | Löcher/Holes Trous/Huecos | △ kg | FASSCO-Id. Qualität/Quality/Calid. | €/Stück Pce./Pce./Pza. |
|----------------------------------|--|------------------------------|---------|---------------------------------------|---------------------------|
| 34" | 1041,4 x 127 x 12,6 41" x 5" x .496" (ZA 278B) | 1/2"-12 | 11,50 | 052.12F220 | * |
| | | | | 052.12F3000 | * |
| 38" | 1143 x 127 x 12,6 45" x 5" x .496" (ZB 278A) | 1/2"-12 | 12,60 | 052.13F220 | * |
| | | | | 052.13F3000 | * |
| 44" | 1295,4 x 127 x 12,6 51" x 5" x .496" (ZC 278A) | 1/2"-12 | 14,30 | 052.14F220 | * |
| | | | | 052.14F3000 | * |
| 48" | 1397 x 127 x 12,6 55" x 5" x .496" (ZD 278A) | 27 1/2"-12 | 15,50 | 052.15F220 | * |
| | | | | 052.15F3000 | * |
| 54" | 1549,4 x 127 x 12,6 61" x 5" x .496" (ZE 278A) | 20 1/2"-12 | 17,10 | 052.16F220 | * |
| | | | | 052.16F3000 | * |
| 64" | 1803,4 x 127 x 12,6 71" x 5" x .496" (ZF 278A) | 1/2"-12 | 20,00 | 052.17F220 | * |
| | | | | 052.17F3000 | * |

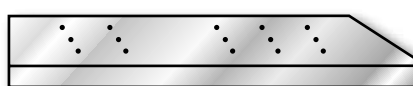

SEYBOLD

| Maschinen-Type Type/Type/Tipo | Abmessungen in mm Size/Dimension/Tamaño | Löcher/Holes Trous/Huecos | kg | FASSCO-Id. Qualität/Quality/Calid. | €/Stück Pce./Pce./Pza. |
|----------------------------------|---|------------------------------|-------|---------------------------------------|---------------------------|
| 3VA | Vordermesser 3VA208 838,2 x 127 x 12,6 33" x 5" x .496" | 15 1/2"-12 3 .253" Ø | 9,30 | 052.90/001F220 | * |
| | | | | 052.90/001F3000 | * |
| | Seitenmesser, links 3VA210D 635 x 139,7 x 12,6 25" x 5.1/2" x .496" | 15 1/2"-12 2 5/16" Ø | 6,80 | 052.90/002F220 | * |
| | | | | 052.90/002F3000 | * |
| | Seitenmesser, rechts 3VA209D 635 x 139,7 x 12,6 25" x 5.1/2" x .496" | 15 1/2"-12 2 5/16" Ø | 6,80 | 052.90/003F220 | * |
| | | | | 052.90/003F3000 | * |
| €/Satz/Set/Jeu/Juego | | | | | |
| 3VA | kompletter Satz complete set | = 3 Messer = 3 knives | 22,90 | 052.90/300F220 | * |
| | | | | 052.90/300F3000 | * |

| Maschinen-Type Type/Type/Tipo | Abmessungen in mm Size/Dimension/Tamaño | Löcher/Holes Trous/Huecos | kg | FASSCO-Id. Qualität/Quality/Calid. | €/Stück Pce./Pce./Pza. |
|----------------------------------|--|------------------------------|-------|---------------------------------------|---------------------------|
| 4VA | Vordermesser 609,6 x 127 x 12,6 24" x 5" x .496" | 18 1/2"-12 2 5/16" Ø | 6,70 | 052.91/001F220 | * |
| | | | | 052.91/001F3000 | * |
| | Seitenmesser, links 482,6 x 127 x 12,6 19" x 5" x .496" | 15 1/2"-12 4 5/16" Ø | 5,15 | 052.91/023F220 | * |
| | | | | 052.91/023F3000 | * |
| | Seitenmesser, rechts 482,6 x 127 x 12,6 19" x 5" x .496" | 15 1/2"-12 4 5/16" Ø | 5,15 | 052.91/023F220 | * |
| | | | | 052.91/023F3000 | * |
| €/Satz/Set/Jeu/Juego | | | | | |
| 4VA | kompletter Satz complete set | = 3 Messer = 3 knives | 17,00 | 052.91/300F220 | * |
| | | | | 052.91/300F3000 | * |

SHENJIAN



| Maschinen-Type Type/Type/Tipo | Abmessungen in mm Size/Dimension/Tamaño | Löcher/Holes Trous/Huecos | ⚖ kg | FASSCO-Id. Qualität/Quality/Calid. | €/Stück Pce./Pce./Pza. |
|----------------------------------|---|------------------------------|---------|---------------------------------------|---------------------------|
| QS-02 | Vordermesser QS-0409 494 x 127 x 12,7 | 2/M10 | 5,50 | 065.90/001F220 | * |
| | | | | 065.90/001F3000 | * |
| | Seitenmesser, links QS-0507 372 x 127 x 12,7 | 2/M10 | 3,80 | 065.90/002F220 | * |
| | | | | 065.90/002F3000 | * |
| | Seitenmesser, rechts QS-0511 372 x 127 x 12,7 | 2/M10 | 3,80 | 065.90/003F220 | * |
| | | | | 065.90/003F3000 | * |
| €/Satz/Set/Jeu/Juego | | | | | |
| QS-02 | kompletter Satz complete set | = 3 Messer = 3 knives | 13,10 | 065.90/300F220 | * |
| | | | | 065.90/300F3000 | * |

SHEN WEI DA (124)

Shanghai Shen Wei Da Machinery



| Maschinen-Type Type/Type/Tipo | Abmessungen in mm Size/Dimension/Tamaño | Löcher/Holes Trous/Huecos | ⚖ kg | FASSCO-Id. Qualität/Quality/Calid. | €/Stück Pce./Pce./Pza. |
|--|--|------------------------------|---------|---------------------------------------|---------------------------|
| SWD/FD 780 SQZK 780 30" (ident. FEIDA) | 970 x 127 x 12,7 | 16/M12 +MWE | 10,80 | 013.06F220 | * |
| | | | | 013.06F3000 | * |
| SWD/FD 920 SQZK 920 36" (ident. FEIDA) | 1080 x 127 x 12,7 | 18/M12 +MWE | 12,05 | 013.02F220 | * |
| | | | | 013.02F3000 | * |
| SWD 1150 SQZK 1150 45" (ident. POLAR) | 1390 x 160 x 13,75 | 26/M12 +MWE | 21,35 | 007.24F220 | * |
| | | | | 007.24F3000 | * |
| SWD 1370 SQZK 1370 54" (ident. POLAR) | 1605 x 160 x 13,75 | 30/M12 +MWE | 24,50 | 007.27F220 | * |
| | | | | 007.27F3000 | * |



SHERIDAN

(AM GRAPHICS)

| Maschinen-Type Type/Type/Tipo | Abmessungen in mm Size/Dimension/Tamaño | Löcher/Holes Trous/Huecos | △ kg | FASSCO-Id. Qualität/Quality/Calid. | €/Stück Pce./Pce./Pza. |
|----------------------------------|---|------------------------------|---------|---------------------------------------|---------------------------|
| | 1066,8 x 127 x 12,32 42" x 5" x .485" | 12 1/2"-12 | 11,50 | 047.01F220 | * |
| | | | | 047.01F3000 | * |
| | 1168,4 x 139,7 x 13,97 46" x 5.50" x .557" | 12 5/8"-11 | 15,75 | 047.02F220 | * |
| | | | | 047.02F3000 | * |

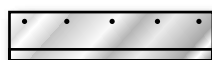

SHERIDAN

(AM GRAPHICS)

| Maschinen-Type Type/Type/Tipo | Abmessungen in mm Size/Dimension/Tamaño | Löcher/Holes Trous/Huecos | △ kg | FASSCO-Id. Qualität/Quality/Calid. | €/Stück Pce./Pce./Pza. |
|---|---|------------------------------|----------------|---------------------------------------|---------------------------|
| AT-Trimmer | Vordermesser, oben AT-50 457,2 x 76,2 x 12,7 18" x 3" x .500" | 5 1/2"-13 2 3/8"-24 | 2,75 | 047.96/001F236 | * |
| | | | | 047.96/001F3000 | * |
| | Seitenmesser, oben links AT-59 330,2 x 76,2 x 12,7 13" x 3" x .500" | 4 1/2"-13 2 3/8"-24 | 1,95 | 047.96/023F236 | * |
| | | | | 047.96/023F3000 | * |
| | Seitenmesser, oben rechts AT-59 330,2 x 76,2 x 12,7 13" x 3" x .500" | 4 1/2"-13 2 3/8"-24 | 1,95 | 047.96/023F236 | * |
| | | | | 047.96/023F3000 | * |
| | Vordermesser, unten AT-47 457,2 x 31,75 x 12,7 18" x 1.250" x .500" | 5 vers.Lö. 2 1/4"-20 | 1,25 | 047.96/101F236 | * |
| | | | | | |
| Seitenmesser, unten links AT-66 330,2 x 31,75 x 12,7 13" x 1.250" x .500" | 4 vers. Lö. 2 1/4"-20 | 0,93 | 047.96/123F236 | * | |
| | | | | | |
| Seitenmesser, unten rechts AT-66 330,2 x 31,75 x 12,7 13" x 1.250" x .500" | 4 vers. Lö. 2 1/4"-20 | 0,93 | 047.96/123F236 | * | |
| | | | | | |
| €/Satz/Set/Jeu/Juego | | | | | |
| AT-Trimmer | Satz Obermesser Set Upper knives | = 3 Messer = 3 knives | 6,65 | 047.96/300F236 | * |
| | Satz Obermesser Set Upper knives | = 3 Messer = 3 knives | 6,65 | 047.96/300F3000 | * |
| | Satz Untermesser Set Bottom knives | = 3 Messer = 3 knives | 3,11 | 047.96/303F236 | * |

SHERIDAN

(AM GRAPHICS)



| Maschinen-Type Type/Type/Tipo | Abmessungen in mm Size/Dimension/Tamaño | Löcher/Holes Trous/Huecos | ⚖️ kg | FASSCO-Id. Qualität/Quality/Calid. | €/Stück Pce./Pce./Pza. |
|---|---|------------------------------|----------------|---------------------------------------|---------------------------|
| BT-Trimmer | Vordermesser, oben BT-441 558,8 x 76,2 x 12,7 22" x 3" x .500" | 6 1/2"-13 2 1/4"-20 | 3,30 | 047.94/001F236 | * |
| | | | | 047.94/001F3000 | * |
| | Seitenmesser, oben links AT-59 330,2 x 76,2 x 12,7 13" x 3" x .500" | 4 1/2"-13 2 3/8"-24 | 1,95 | 047.96/023F236 | * |
| | | | | 047.96/023F3000 | * |
| | Seitenmesser, oben rechts AT-59 330,2 x 76,2 x 12,7 13" x 3" x .500" | 4 1/2"-13 2 3/8"-24 | 1,95 | 047.96/023F236 | * |
| | | | | 047.96/023F3000 | * |
| | Vordermesser, unten BT-440 558,8 x 31,75 x 12,7 22" x 1.250" x .500" | 4 vers.Lö. 2 1/4"-20 | 1,41 | 047.94/101F236 | * |
| Seitenmesser, unten links AT-66 330,2 x 31,75 x 12,7 13" x 1.250" x .500" | 4 vers. Lö. 2 1/4"-20 | 0,93 | 047.96/123F236 | * | |
| Seitenmesser, unten rechts AT-66 330,2 x 31,75 x 12,7 13" x 1.250" x .500" | 4 vers.Lö. 2 1/4"-20 | 0,93 | 047.96/123F236 | * | |
| €/Satz/Set/Jeu/Juego | | | | | |
| BT-Trimmer | Satz Obermesser Set Upper knives | = 3 Messer = 3 knives | 7,20 | 047.94/300F236 | * |
| | Satz Obermesser Set Upper knives | = 3 Messer = 3 knives | 7,20 | 047.94/300F3000 | * |
| | Satz Untermesser Set Bottom knives | = 3 Messer = 3 knives | 3,27 | 047.94/303F236 | * |

S



| Maschinen-Type Type/Type/Tipo | Abmessungen in mm Size/Dimension/Tamaño | Löcher/Holes Trous/Huecos | △ kg | FASSCO-Id. Qualität/Quality/Calid. | €/Stück Pce./Pce./Pza. |
|---|--|------------------------------|----------------|---------------------------------------|---------------------------|
| FT-Trimmer | Vordermesser, oben FT-11A-105 558,8 x 88,9 x 12,7 22" x 3.1/2" x .500" | | 3,90 | 047.95/001F236 | * |
| | | | | 047.95/001F3000 | * |
| | Seitenmesser, oben links BT-552/ FT-24A-135 330,2 x 88,9 x 12,7 13" x 3.1/2" x .500" | | 2,30 | 047.95/023F236 | * |
| | | | | 047.95/023F3000 | * |
| | Seitenmesser, oben rechts BT-552/ FT-24A-135 330,2 x 88,9 x 12,7 13" x 3.1/2" x .500" | | 2,30 | 047.95/023F236 | * |
| | | | | 047.95/023F3000 | * |
| | Vordermesser, unten FT-11A-111 558,8 x 31,75 x 12,7 22" x 1.250" x .500" | | | 1,41 | 047.95/101F236 |
| Seitenmesser, unten links AT-66 330,2 x 31,75 x 12,7 13" x 1.250" x .500" | 4 vers.Lö 2 1/4"-20 | 0,93 | 047.96/123F236 | * | |
| Seitenmesser, unten rechts AT-66 330,2 x 31,75 x 12,7 13" x 1.250" x .500" | 4 vers.Lö. 2 1/4"-20 | 0,93 | 047.96/123F236 | * | |
| €/Satz/Set/Jeu/Juego | | | | | |
| FT-Trimmer | Satz Obermesser Set Upper knives | = 3 Messer = 3 knives | 8,50 | 047.95/300F236 | * |
| | Satz Obermesser Set Upper knives | = 3 Messer = 3 knives | 8,50 | 047.95/300F3000 | * |
| | Satz Untermesser Set Bottom knives | = 3 Messer = 3 knives | 3,27 | 047.95/303F236 | * |



SHERIDAN

(AM GRAPHICS)



| Maschinen-Type Type/Type/Tipo | Abmessungen in mm Size/Dimension/Tamaño | Löcher/Holes Trous/Huecos | ⚖️ kg | FASSCO-Id. Qualität/Quality/Calid. | €/Stück Pce./Pce./Pza. |
|---|--|------------------------------|----------------|---------------------------------------|---------------------------|
| CT-Trimmer Standard | Vordermesser, oben CT-14B-218 546,1 x 127 x 12,7 21.1/2" x 5" x .500" | 10 1/2"-13 6 1/4"-20 | 5,95 | 047.90/001F220 | * |
| | | | | 047.90/001F3000 | * |
| | Seitenmesser, oben links CT-555-1 355,6 x 127 x 12,7 14" x 5" x .500" | 8 1/2"-13 2 1/4"-20 | 3,80 | 047.90/023F220 | * |
| | | | | 047.90/023F3000 | * |
| | Seitenmesser, oben rechts CT-555-1 355,6 x 127 x 12,7 14" x 5" x .500" | 8 1/2"-13 2 1/4"-20 | 3,80 | 047.90/023F220 | * |
| | | | | 047.90/023F3000 | * |
| | Vordermesser, unten CT-453-2 501,65 x 44,45 x 12,7 19.3/4" x 1.750" x .500" | 5 vers.Lö. 2 1/4"-20 | 2,00 | 047.90/101F236 | * |
| Seitenmesser, unten links CT-551-11X2 330,2 x 31,75 x 12,7 13" x 1.250" x .500" | 4 vers.Lö. 2 1/4"-20 | 0,93 | 047.90/123F236 | * | |
| Seitenmesser, unten rechts CT-551-11X2 330,2 x 31,75 x 12,7 13" x 1.250" x .500" | 4 vers.Lö. 2 1/4"-20 | 0,93 | 047.90/123F236 | * | |
| €/Satz/Set/Jeu/Juego | | | | | |
| CT-Trimmer Standard | Satz Obermesser Set Upper knives | = 3 Messer = 3 knives | 13,55 | 047.90/300F220 | * |
| | Satz Obermesser Set Upper knives | = 3 Messer = 3 knives | 13,55 | 047.90/300F3000 | * |
| | Satz Untermesser Set Bottom knives | = 3 Messer = 3 knives | 3,86 | 047.90/303F236 | * |

S



| Maschinen-Type Type/Type/Tipo | Abmessungen in mm Size/Dimension/Tamaño | Löcher/Holes Trous/Huecos | △ kg | FASSCO-Id. Qualität/Quality/Calid. | €/Stück Pce./Pce./Pza. |
|--|--|------------------------------|---------|---------------------------------------|---------------------------|
| CT-Trimmer Spezial Modell Special Model | Vordermesser, oben CT-14B-218 546,1 x 127 x 12,7 21.1/2" x 5" x .500" | 10 1/2"-13 6 1/4"-20 | 5,95 | 047.90/001F220 | * |
| | | | | 047.90/001F3000 | * |
| | Seitenmesser, oben links CT-551-45/ CT-15B-345 368,3 x 127 x 12,7 14.1/2" x 5" x .500" | 8 1/2"-13 2 1/4"-20 | 3,95 | 047.91/002F220 | * |
| | | | | 047.91/002F3000 | * |
| | Seitenmesser, oben rechts CT-553-23/ CT-15B-346 368,3 x 127 x 12,7 14.1/2" x 5" x .500" | 8 1/2"-13 2 1/4"-20 | 3,95 | 047.91/003F220 | * |
| | | | | 047.91/003F3000 | * |
| | Vordermesser, unten CT-453-2 501,65 x 44,45 x 12,7 19.3/4" x 1.750" x .500" | 5 vers.Lö. 2 1/4"-20 | 2,00 | 047.90/101F236 | * |
| | Seitenmesser, unten links CT-551-11X2 330,2 x 31,75 x 12,7 13" x 1.250" x .500" | 4 vers.Lö. 2 1/4"-20 | 0,93 | 047.90/123F236 | * |
| | Seitenmesser, unten rechts CT-551-11X2 330,2 x 31,75 x 12,7 13" x 1.250" x .500" | 4 vers.Lö. 2 1/4"-20 | 0,93 | 047.90/123F236 | * |
| €/Satz/Set/Jeu/Juego | | | | | |
| CT-Trimmer Spezial Modell Special Model | Satz Obermesser Set Upper knives | = 3 Messer = 3 knives | 13,85 | 047.91/300F220 | * |
| | Satz Obermesser Set Upper knives | = 3 Messer = 3 knives | 13,85 | 047.91/300F3000 | * |
| | Satz Untermesser Set Bottom knives | = 3 Messer = 3 knives | 3,86 | 047.90/303F236 | * |

SHERIDAN

(AM GRAPHICS)



| Maschinen-Type Type/Type/Tipo | Abmessungen in mm Size/Dimension/Tamaño | Löcher/Holes Trous/Huecos | ⚖️ kg | FASSCO-Id. Qualität/Quality/Calid. | €/Stück Pce./Pce./Pza. |
|---|---|------------------------------|----------------|---------------------------------------|---------------------------|
| CT-Trimmer Modell CT-325 Model CT-325 | Vordermesser, oben CT-14B-218 546,1 x 127 x 12,7 21.1/2" x 5" x .500" | 10 1/2"-13 6 1/4"-20 | 5,95 | 047.90/001F220 | * |
| | | | | 047.90/001F3000 | * |
| | Seitenmesser, oben links CT-15C-354 368,3 x 127 x 12,7 14.1/2" x 5" x .500" | 8 1/2"-13 2 1/4"-20 | 3,80 | 047.92/023F220 | * |
| | | | | 047.92/023F3000 | * |
| | Seitenmesser, oben rechts CT-15C-354 368,3 x 127 x 12,7 14.1/2" x 5" x .500" | 8 1/2"-13 2 1/4"-20 | 3,80 | 047.92/023F220 | * |
| | | | | 047.92/023F3000 | * |
| | Vordermesser, unten CT-453-2 501,65 x 44,45 x 12,7 19.3/4" x 1.750" x .500" | 5 vers.Lö. 2 1/4"-20 | 2,00 | 047.90/101F236 | * |
| Seitenmesser, unten links CT-551-11X2 330,2 x 31,75 x 12,7 13" x 1.250" x .500" | 4 vers.Lö. 2 1/4"-20 | 0,93 | 047.90/123F236 | * | |
| Seitenmesser, unten rechts CT-551-11X2 330,2 x 31,75 x 12,7 13" x 1.250" x .500" | 4 vers.Lö. 2 1/4"-20 | 0,93 | 047.90/123F236 | * | |
| €/Satz/Set/Jeu/Juego | | | | | |
| CT-Trimmer Modell CT-325 Model CT-325 | Satz Obermesser Set Upper knives | = 3 Messer = 3 knives | 13,55 | 047.92/300F220 | * |
| | Satz Obermesser Set Upper knives | = 3 Messer = 3 knives | 13,55 | 047.92/300F3000 | * |
| | Satz Untermesser Set Bottom knives | = 3 Messer = 3 knives | 3,86 | 047.90/303F236 | * |

| Maschinen-Type Type/Type/Tipo | Abmessungen in mm Size/Dimension/Tamaño | Löcher/Holes Trous/Huecos | ⚖️ kg | FASSCO-Id. Qualität/Quality/Calid. | €/Stück Pce./Pce./Pza. |
|---|--|------------------------------|----------|---------------------------------------|---------------------------|
| CT-Trimmer andere Modelle other Models | Seitenmesser, unten CT-551-11X1 330 x 31,75 x 12,7 13" x 1.250" x .500" | 4 vers.Lö. 2 3/8"-24NF | 0,90 | 047.90/134F236 | * |
| | Seitenmesser, unten CT-551-11 330 x 38,1 x 12,7 13" x 1.500" x .500" | 4 vers.Lö. 2 3/8"-24NF | 1,08 | 047.90/145F236 | * |



SHERIDAN

(AM GRAPHICS)

| Maschinen-Type Type/Type/Tipo | Abmessungen in mm Size/Dimension/Tamaño | Löcher/Holes Trous/Huecos | △ kg | FASSCO-Id. Qualität/Quality/Calid. | €/Stück Pce./Pce./Pza. |
|---|---|------------------------------|---------|---------------------------------------|---------------------------|
| HT-Trimmer Standard SP 855 | Vordermesser, oben HT-11B-103G 514,35 x 114,3 x 6,35 20.250" x 4.500" x .250" | 5 Langlöcher | 2,60 | 047.93/021F3000 | * |
| | Seitenmesser, oben links HT-12C-105 323,85 x 101,6 x 6,35 12.3/4" x 4" x .250" | 5 Langlöcher | 1,43 | 047.93/023F3000 | * |
| | Seitenmesser, oben rechts HT-12C-105 323,85 x 101,6 x 6,35 12.3/4" x 4" x .250" | 5 Langlöcher | 1,43 | 047.93/023F3000 | * |
| | Vordermesser, unten HT-11B-104A 533,4 x 31,75 x 12,7 21" x 1.250" x .500" | 5 vers.Lö. 4 1/4"-28 | 1,50 | 047.93/101F236 | * |
| | Seitenmesser, unten links HT-12B-107A 317,5 x 31,75 x 12,7 12.500" x 1.250" x .500" | 4 vers.Lö. 3 1/4"-28 | 0,87 | 047.93/123F236 | * |
| | Seitenmesser, unten rechts HT-12B-107A 317,5 x 31,75 x 12,7 12.500" x 1.250" x .500" | 4 vers.Lö. 3 1/4"-28 | 0,87 | 047.93/123F236 | * |
| €/Satz/Set/Jeu/Juego | | | | | |
| HT-Trimmer Standard SP 855 | Satz Obermesser Set Upper knives | = 3 Messer = 3 knives | 5,46 | 047.93/300F3000 | * |
| | Satz Untermesser Set Bottom knives | = 3 Messer = 3 knives | 3,24 | 047.93/303F236 | * |

S

SHERIDAN

(AM GRAPHICS)



| Maschinen-Type Type/Type/Tipo | Abmessungen in mm Size/Dimension/Tamaño | Löcher/Holes Trous/Huecos | ⚖ kg | FASSCO-Id. Qualität/Quality/Calid. | €/Stück Pce./Pce./Pza. |
|--|---|------------------------------|---------|---------------------------------------|---------------------------|
| HT-Trimmer Modell HT-18 Model HT-18 | Vordermesser, oben HT-31C-122 355,6 x 114,3 x 6,35 14" x 4.1/2" x .250" | 4 Langlöcher | 1,80 | 047.93/024F3000 | * |
| | Seitenmesser, oben links HT-32C-103 269,87 x 101,6 x 6,35 10.625" x 4" x .250" | 5 Langlöcher | 1,15 | 047.93/025F3000 | * |
| | Seitenmesser, oben rechts HT-32C-103 269,87 x 101,6 x 6,35 10.625" x 4" x .250" | 5 Langlöcher | 1,15 | 047.93/025F3000 | * |
| | Vordermesser, unten HT-31C-121 381 x 31,75 x 12,7 15" x 1.250" x .500" | 4 vers.Lö. 4 1/4"-28 | 1,05 | 047.93/124F236 | * |
| | Seitenmesser, unten links HT-12B-107A 317,5 x 31,75 x 12,7 12.500" x 1.250" x .500" | 4 vers.Lö. 3 1/4"-28 | 0,87 | 047.93/123F236 | * |
| | Seitenmesser, unten rechts HT-12B-107A 317,5 x 31,75 x 12,7 12.500" x 1.250" x .500" | 4 vers.Lö. 3 1/4"-28 | 0,87 | 047.93/123F236 | * |
| €/Satz/Set/Jeu/Juego | | | | | |
| HT-Trimmer Modell HT-18 Model HT-18 | Satz Obermesser Set Upper knives | = 3 Messer = 3 knives | 4,10 | 047.98/300F3000 | * |
| | Satz Untermesser Set Bottom knives | = 3 Messer = 3 knives | 2,79 | 047.98/303F236 | * |

S

**SHERIDAN**

(AM GRAPHICS)

| Maschinen-Type Type/Type/Tipo | Abmessungen in mm Size/Dimension/Tamaño | Löcher/Holes Trous/Huecos |  kg | FASSCO-Id. Qualität/Quality/Calid. | €/Stück Pce./Pce./Pza. |
|--|--|------------------------------|---|---------------------------------------|---------------------------|
| HT-Trimmer Modell HT 151 Model HT 151 | Vordermesser, oben HT-52-162 381 x 114,3 x 6,35 15" x 4.500" x .250" | 4 Langlöcher | 1,95 | 047.93/027F3000 | * |
| | Seitenmesser, oben links HT-52-212 311,15 x 107,95 x 12,7 12.250" x 4.250" x .500" | 12 3/8"-16 | 2,95 | 047.93/028F3000 | * |
| | Seitenmesser, oben rechts HT-52-212 311,15 x 107,95 x 12,7 12.250" x 4.250" x .500" | 12 3/8"-16 | 2,95 | 047.93/028F3000 | * |
| | Vordermesser, unten HT-52-202 463,55 x 31,75 x 12,7 18.250" x 1.250" x .500" | 5 vers.Lö. 4 1/4"-28 | 1,27 | 047.93/125F236 | * |
| | Seitenmesser, unten links HT-31C-121 381 x 31,75 x 12,7 15" x 1.250" x .500" | 4 vers.Lö. 4 1/4"-28 | 1,05 | 047.93/124F236 | * |
| | Seitenmesser, unten rechts HT-31C-121 381 x 31,75 x 12,7 15" x 1.250" x .500" | 4 vers.Lö. 4 1/4"-28 | 1,05 | 047.93/124F236 | * |
| €/Satz/Set/Jeu/Juego | | | | | |
| HT-Trimmer Modell HT 151 Model HT 151 | Satz Obermesser Set Upper knives | = 3 Messer = 3 knives | 7,85 | 047.93A /300F3000 | * |
| | Satz Untermesser Set Bottom knives | = 3 Messer = 3 knives | 3,37 | 047.98A/303F236 | * |

SHERIDAN

(AM GRAPHICS)



| Maschinen-Type Type/Type/Tipo | Abmessungen in mm Size/Dimension/Tamaño | Löcher/Holes Trous/Huecos | kg | FASSCO-Id. Qualität/Quality/Calid. | €/Stück Pce./Pce./Pza. |
|--|---|------------------------------|------|---------------------------------------|---------------------------|
| HT-Trimmer andere Modelle other Models | Vordermesser, oben HT-11B-103E 457,2 x 114,3 x 6,35 18" x 4.500" x .250" | 5 Langlöcher | 2,30 | 047.93/011F3000 | * |
| | Vordermesser, oben HT-11B-103 584,2 x 114,3 x 6,35 23" x 4.500" x .250" | 7 Langlöcher | 2,95 | 047.93/001F3000 | * |
| | Vordermesser, oben HT-11B-103D 609,6 x 114,3 x 6,35 24" x 4.500" x .250" | 7 Langlöcher | 3,10 | 047.93/041F3000 | * |
| | Seitenmesser, oben HT-32C-100 285,37 x 101,6 x 6,35 11.235" x 4.000" x .250" | 5 Langlöcher | 1,26 | 047.93/026F3000 | * |
| | Seitenmesser, oben links HT-22 285,75 x 101,6 x 6,35 11.250" x 4.000" x .250" | 5 Langlöcher | 1,26 | 047.93/030F3000 | * |
| | Seitenmesser, oben rechts HT-22 285,75 x 101,6 x 6,35 11.250" x 4.000" x .250" | 5 Langlöcher | 1,26 | 047.93/029F3000 | * |
| | Seitenmesser, oben HT-52-220 311,15 x 76,2 x 9,52 12.250" x 3.000" x .375" | 5 Langlöcher 2 1/4"-20NC | 1,60 | 047.93/031F3000 | * |
| | Vordermesser, unten HT-11B-104B 615,95 x 31,75 x 12,7 24.250" x 1.250" x .500" | 6 vers.Lö. 5 1/4"-28 | 1,70 | 047.93/141F236 | * |
| | Seitenmesser, unten HT-21B-105 317,5 x 25,4 x 12,7 12.500" x 1.000" x .500" | 4 vers.Lö. 3 1/4"-28 | 0,72 | 047.93/145F236 | * |

S

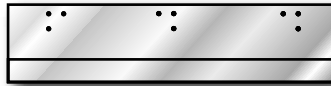
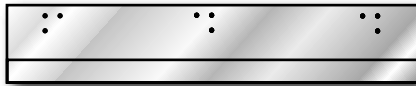

SHERIDAN

(AM GRAPHICS)

| Maschinen-Type Type/Type/Tipo | Abmessungen in mm Size/Dimension/Tamaño | Löcher/Holes Trous/Huecos | △ kg | FASSCO-Id. Qualität/Quality/Calid. | €/Stück Pce./Pce./Pza. |
|----------------------------------|--|------------------------------|---------|---------------------------------------|---------------------------|
| HARRIS 500 | Vordermesser, oben 514,35 x 101,6 x 6,35 20.250" x 4" x .250" | 5 Langlöcher | 2,25 | 047.97/001F3000 | * |
| | Seitenmesser, oben links 323,85 x 101,6 x 6,35 12.3/4" x 4" x .250" | 5 Langlöcher | 1,43 | 047.97/023F3000 | * |
| | Seitenmesser, oben rechts 323,85 x 101,6 x 6,35 12.3/4" x 4" x .250" | 5 Langlöcher | 1,43 | 047.97/023F3000 | * |
| | Vordermesser, unten 533,4 x 25,4 x 12,7 21" x 1" x .500" | 5 vers.Lö. 4 1/4"-20 | 1,20 | 047.97/101F236 | * |
| | Seitenmesser, unten links 317,5 x 25,4 x 12,7 12.500" x 1" x .500" | 4 vers.Lö. 3 1/4"-20 | 0,73 | 047.97/123F236 | * |
| | Seitenmesser, unten rechts 317,5 x 25,4 x 12,7 12.500" x 1" x .500" | 4 vers.Lö. 3 1/4"-20 | 0,73 | 047.97/123F236 | * |
| €/Satz/Set/Jeu/Juego | | | | | |
| HARRIS 500 | Satz Obermesser Set Upper knives | = 3 Messer = 3 knives | 5,11 | 047.97/300F3000 | * |
| | Satz Untermesser Set Bottom knives | = 3 Messer = 3 knives | 2,66 | 047.97/303F236 | * |

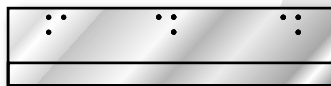

SHERIDAN

(AM GRAPHICS)

| Maschinen-Type Type/Type/Tipo | Abmessungen in mm Size/Dimension/Tamaño | Löcher/Holes Trous/Huecos | △ kg | FASSCO-Id. Qualität/Quality/Calid. | €/Stück Pce./Pce./Pza. |
|----------------------------------|---|------------------------------|---------|---------------------------------------|---------------------------|
| VT-I SL-Trimmer | Vordermesser 14658-2 635 x 139,7 x 12,7 25" x 5.1/2" x .500" | 6 1/2"-12 3 1/4"-20 | 7,95 | 047.89/001F220 | * |
| | | | | 047.89/001F3000 | * |
| | Seitenmesser, links 14389-1 508 x 139,7 x 12,7 20" x 5.1/2" x .500" | 6 1/2"-12 3 1/4"-20 | 6,30 | 047.89/023F220 | * |
| | | | | 047.89/023F3000 | * |
| | Seitenmesser, rechts 14389-1 508 x 139,7 x 12,7 20" x 5.1/2" x .500" | 6 1/2"-12 3 1/4"-20 | 6,30 | 047.89/023F220 | * |
| | | | | 047.89/023F3000 | * |
| €/Satz/Set/Jeu/Juego | | | | | |
| VT-I SL-Trimmer | kompletter Satz complete set | = 3 Messer = 3 knives | 20,55 | 047.89/300F220 | * |
| | | | | 047.89/300F3000 | * |

S

SHERIDAN

(AM GRAPHICS)

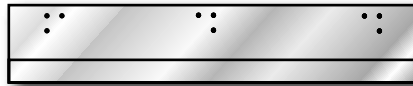

| Maschinen-Type Type/Type/Tipo | Abmessungen in mm Size/Dimension/Tamaño | Löcher/Holes Trous/Huecos | kg | FASSCO-Id. Qualität/Quality/Calid. | €/Stück Pce./Pce./Pza. |
|----------------------------------|---|------------------------------|-------|---------------------------------------|---------------------------|
| VT II | Vordermesser VT II B 108 711,2 x 139,7 x 12,7 28" x 5.1/2" x .500" | 8 1/2"-12 3 1/4"-20 | 8,90 | 047.88/001F220 | * |
| | | | | 047.88/001F3000 | * |
| | Seitenmesser, links 14389-1 508 x 139,7 x 12,7 20" x 5.1/2" x .500" | 6 1/2"-12 3 1/4"-20 | 6,30 | 047.89/023F220 | * |
| | | | | 047.89/023F3000 | * |
| | Seitenmesser, rechts 14389-1 508 x 139,7 x 12,7 20" x 5.1/2" x .500" | 6 1/2"-12 3 1/4"-20 | 6,30 | 047.89/023F220 | * |
| | | | | 047.89/023F3000 | * |
| €/Satz/Set/Jeu/Juego | | | | | |
| VT II | kompletter Satz complete set | = 3 Messer = 3 knives | 21,50 | 047.88/300F220 | * |
| | | | | 047.88/300F3000 | * |

SHERIDAN

(AM GRAPHICS)

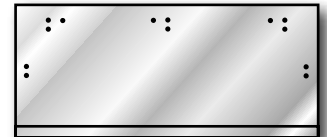

| Maschinen-Type Type/Type/Tipo | Abmessungen in mm Size/Dimension/Tamaño | Löcher/Holes Trous/Huecos | kg | FASSCO-Id. Qualität/Quality/Calid. | €/Stück Pce./Pce./Pza. | | | |
|-------------------------------------|--|-------------------------------------|------|--|-------------------------------------|------|---|-------------------------------------|
| VT 200 Trennschnitt Split cut | Trennmesser B 116925 508 x 215,9 x 6,35 20" x 8.50" x .250" | 6 1/2"-20 3 1/4"-20 6 3/8"-16 | 4,90 | 047.87/045F236 | * | | | |
| | | | | Trennmesser (B 116925) 508 x 215,9 x 6,35 20" x 8.50" x .250" | 9 1/2"-20 8 1/4"-20 6 3/8"-16 | 4,90 | 047.87/046F236 | * |
| | | | | | | | Trennmesser (kurz) 304,8 x 215,9 x 6,35 12" x 8.50" x .250" | 4 1/2"-20 2 1/4"-20 4 3/8"-16 |



SHORT RUN ENGINEERING

(Paltec)

| Maschinen-Type Type/Type/Tipo | Abmessungen in mm Size/Dimension/Tamaño | Löcher/Holes Trous/Huecos | ⚖ kg | FASSCO-Id. Qualität/Quality/Calid. | €/Stück Pce./Pce./Pza. |
|---|---|------------------------------|---------|---------------------------------------|---------------------------|
| Short Cut Trim Dreischneider Three knife trim. | Vordermesser 470 x 107 x 12 (0321-03.001 02) (0321-10.001) | 4/M10 2/M6 | 3,80 | 117.91/001F220 | * |
| | | | | 117.91/001F3000 | * |
| | Seitenmesser, links 400 x 107 x 12 (0319-07.001 02) (0319-15.001) | 4/M10 2/M6 | 3,50 | 117.91/023F220 | * |
| | | | | 117.91/023F3000 | * |
| | Seitenmesser, rechts 400 x 107 x 12 (0319-07.001 02) (0319-15.001) | 4/M10 2/M6 | 3,50 | 117.91/023F220 | * |
| | | | | 117.91/023F3000 | * |
| €/Satz/Set/Jeu/Juego | | | | | |
| Short Cut Trim Dreischneider | kompletter Satz complete set | = 3 Messer = 3 knives | 10,80 | 117.91/300F220 | * |
| | | | | 117.91/300F3000 | * |

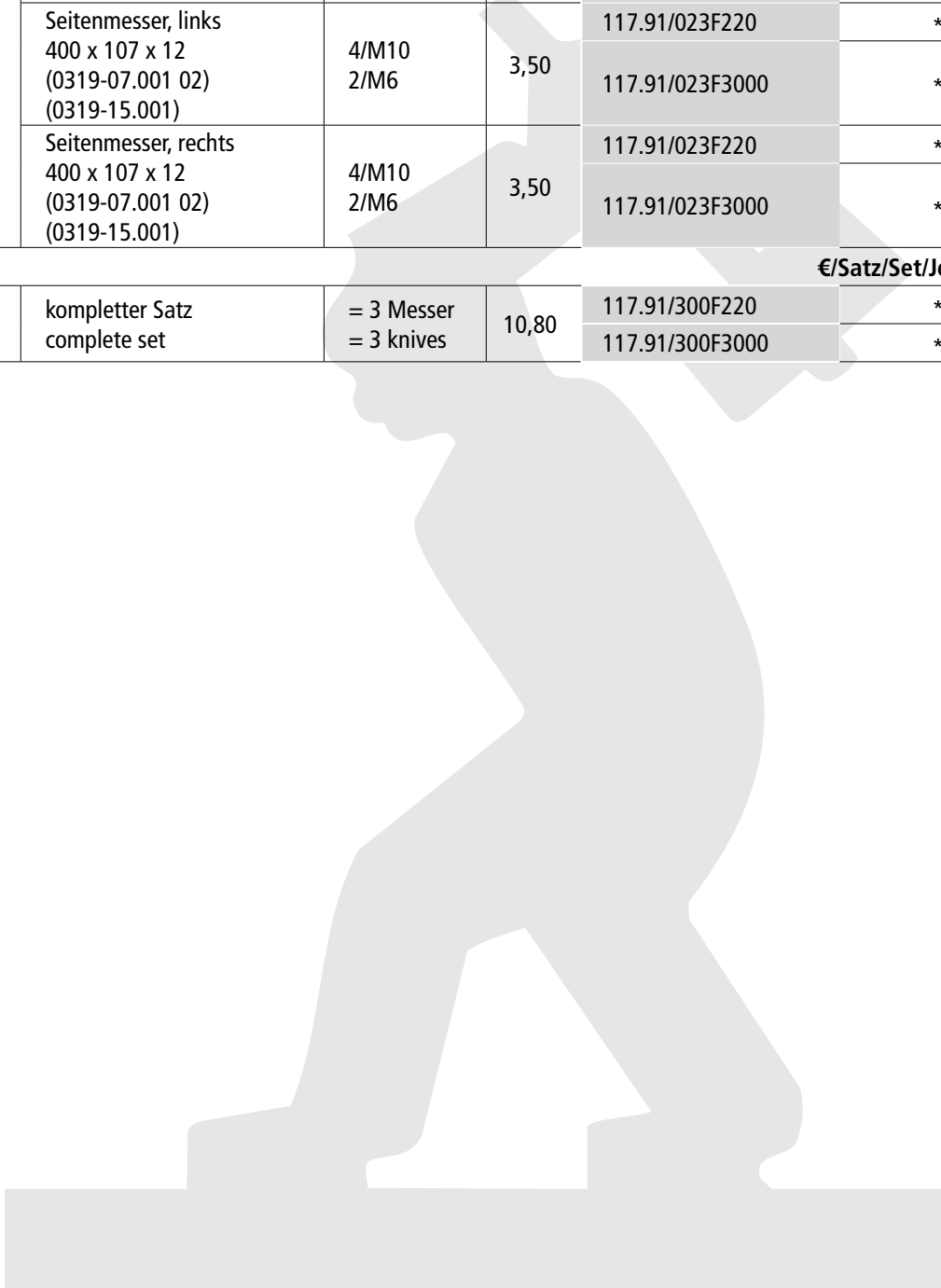

SPERR & LECHNER

(SPLEK, MATIGRAFICA)



| Maschinen-Typ Type/Type/Tipo | Abmessungen in mm Size/Dimension/Tamaño | Löcher/Holes Trous/Huecos | ⚖️ kg | FASSCO-Id. Qualität/Quality/Calid. | €/Stück Pce./Pce./Pza. |
|---------------------------------|--|------------------------------|----------|---------------------------------------|---------------------------|
| HYDROMAT SL III M >1964 | Vordermesser 900-ZB-4/1 580 x 120 x 10 | 10/M12 4/M8 | 4,75 | 011.91/001F220 | * |
| | | | | 011.91/001F3000 | * |
| | Seitenmesser, links 900-ZB-5 510 x 120 x 10 | 8/M12 4/M8 | 3,90 | 011.91/023F220 | * |
| | | | | 011.91/023F3000 | * |
| | Seitenmesser, rechts 900-ZB-5 510 x 120 x 10 | 8/M12 4/M8 | 3,90 | 011.91/023F220 | * |
| | | | | 011.91/023F3000 | * |
| €/Satz/Set/Jeu/Juego | | | | | |
| HYDROMAT SL III M >1964 | kompletter Satz complete set | = 3 Messer = 3 knives | 12,55 | 011.91/300F220 | * |
| | | | | 011.91/300F3000 | * |

| Maschinen-Typ Type/Type/Tipo | Abmessungen in mm Size/Dimension/Tamaño | Löcher/Holes Trous/Huecos | ⚖️ kg | FASSCO-Id. Qualität/Quality/Calid. | €/Stück Pce./Pce./Pza. |
|---------------------------------|--|------------------------------|----------|---------------------------------------|---------------------------|
| SL III M alt/old | Vordermesser 900-01-II 560 x 120 x 10 | 5/M12 2/14,5 Ø | 4,65 | 011.90/001F220 | * |
| | | | | 011.90/001F3000 | * |
| | Seitenmesser, links 900-01-I 510 x 120 x 10 | 4/M12 2/14,5 Ø | 3,90 | 011.90/023F220 | * |
| | | | | 011.90/023F3000 | * |
| | Seitenmesser, rechts 900-01-I 510 x 120 x 10 | 4/M12 2/14,5 Ø | 3,90 | 011.90/023F220 | * |
| | | | | 011.90/023F3000 | * |
| €/Satz/Set/Jeu/Juego | | | | | |
| SL III M alt/old | kompletter Satz complete set | = 3 Messer = 3 knives | 12,45 | 011.90/300F220 | * |
| | | | | 011.90/300F3000 | * |

| Maschinen-Typ Type/Type/Tipo | Abmessungen in mm Size/Dimension/Tamaño | Löcher/Holes Trous/Huecos | ⚖️ kg | FASSCO-Id. Qualität/Quality/Calid. | €/Stück Pce./Pce./Pza. |
|---|--|------------------------------|----------|---------------------------------------|---------------------------|
| SL 900 Tapeten- Dreischneider Wall-paper Three k.trim | Vordermesser 900-ZB-4/3 630 x 120 x 10 | 10/M12 4/M8 | 5,25 | 011.97/001F220 | * |
| | | | | 011.97/001F3000 | * |
| | Seitenmesser, links 900-ZB-8 700 x 120 x 12 | 10/M12 4/M8 | 6,15 | 011.97/002F220 | * |
| | | | | 011.97/002F3000 | * |
| | Seitenmesser, rechts 900-ZB-8 700 x 120 x 12 | 10/M12 4/M8 | 6,15 | 011.97/003F220 | * |
| | | | | 011.97/003F3000 | * |
| €/Satz/Set/Jeu/Juego | | | | | |
| SL 900 Tapeten- Dreischneider | kompletter Satz complete set | = 3 Messer = 3 knives | 17,55 | 011.97/300F220 | * |
| | | | | 011.97/300F3000 | * |



STAHL

| Maschinen-Type Type/Type/Tipo | Abmessungen in mm Size/Dimension/Tamaño | Löcher/Holes Trous/Huecos | ⚖ kg | FASSCO-Id. Qualität/Quality/Calid. | €/Stück Pce./Pce./Pza. |
|----------------------------------|---|------------------------------|---------|---------------------------------------|---------------------------|
| ST 200 (Prototyp) | Vordermesser, oben F241-502-00-11 02 F241-502-00-01-00 580 x 85 x 10 | 7/M8 | 3,30 | 083.90/001F236 | * |
| | | | | 083.90/001F3000 | * |
| | Seitenmesser, oben links F241-503-00-11 02 F241-503-00-01-00 360 x 65 x 10 | 6/M8 | 1,46 | 083.90/023F236 | * |
| | | | | 083.90/023F3000 | * |
| | Seitenmesser, oben rechts F241-503-00-11 02 F241-503-00-01-00 360 x 65 x 10 | 6/M8 | 1,46 | 083.90/023F236 | * |
| | | | | 083.90/023F3000 | * |
| | Vordermesser, unten F241-501-00-11 02 F241-501-00-02 00 600 x 25 x 15 | 6 zyl.vers. Löcher | 1,58 | 083.90/101F236 | * |
| | Seitenmesser, unten links F241-501-00-11 02 F241-501-00-01 00 380 x 25 x 15 | 5 zyl.vers. Löcher | 0,98 | 083.90/123F236 | * |
| | Seitenmesser, unten rechts F241-501-00-11 02 F241-501-00-01 00 380 x 25 x 15 | 5 zyl.vers. Löcher | 0,98 | 083.90/123F236 | * |
| €/Satz/Set/Jeu/Juego | | | | | |
| ST 200 (Prototyp) | Satz Obermesser Set Upper knives | = 3 Messer = 3 knives | 6,22 | 083.90/300F236 | * |
| | Satz Obermesser Set Upper knives | = 3 Messer = 3 knives | 6,22 | 083.90/300F3000 | * |
| | Satz Untermesser Set Bottom knives | = 3 Messer = 3 knives | 3,54 | 083.90/303F236 | * |

| Maschinen-Type Type/Type/Tipo | Abmessungen in mm Size/Dimension/Tamaño | Löcher/Holes Trous/Huecos | ⚖ kg | FASSCO-Id. Qualität/Quality/Calid. | €/Stück Pce./Pce./Pza. |
|---|--|------------------------------|---------|---------------------------------------|---------------------------|
| TM 200 Trennen Fase 24° Split cut Bevel 24° (Prototyp) | Obermesser F241-569-00-11 02 F241-569-00-01 00 365 x 90/63/48,3 x 8 | 6/M8 | 1,10 | 083.62/008F236 | * |
| | Untermesser F241-501-00-11 02 F241-501-00-01 00 380 x 25 x 15 | 5 zyl.vers. Löcher | 0,98 | 083.90/123F236 | * |

STAHL



| Maschinen-Typ Type/Type/Tipo | Abmessungen in mm Size/Dimension/Tamaño | Löcher/Holes Trous/Huecos | ⚖ kg | FASSCO-Id. Qualität/Quality/Calid. | €/Stück Pce./Pce./Pza. |
|---|--|------------------------------|---------|---------------------------------------|---------------------------|
| SM 200 Stanzen V-Fase Punch cut V-Shape (Prototyp) | Obermesser F241-568-00-11 02 F241-568-00-03 00 365 x 90/63/48,3 x 6 | 6/M8 | 0,91 | 083.60/006F236 | * |
| | Obermesser F241-568-00-11 02 F241-568-00-02 00 365 x 90/63/48,3 x 9 | 6/M8 | 1,33 | 083.60/009F236 | * |
| | Obermesser F241-568-00-11 02 F241-568-00-01 00 365 x 90/63/48,3 x 12 | 6/M8 | 1,72 | 083.60/012F236 | * |
| | Untermesser, links F241-501-00-11 02 F241-501-00-01 00 380 x 25 x 15 | 5 zyl.vers. Löcher | 0,98 | 083.90/123F236 | * |
| | Untermesser, rechts F241-501-00-11 02 F241-501-00-01 00 380 x 25 x 15 | 5 zyl.vers. Löcher | 0,98 | 083.90/123F236 | * |

STAHL



| Maschinen-Typ Type/Type/Tipo | Abmessungen in mm Size/Dimension/Tamaño | Löcher/Holes Trous/Huecos | ⚖ kg | FASSCO-Id. Qualität/Quality/Calid. | €/Stück Pce./Pce./Pza. |
|--|--|-------------------------------|---------|---------------------------------------|---------------------------|
| TM 100 Trennen Fase 22° Split cut Bevel 22° altes Modell old Model | Obermesser F242-063-00 11 F242-063-BG 01 362 x 95/76,2 x 9,5 | 5 Langlöcher 2/M12 4/M5 | 1,60 | 083.61F236 | * |
| | Untermesser F242-061-00 11 F242-061-01 00 406,5 x 24,7 x 12,7 | 5 zyl.vers. Langlöcher | 0,83 | 083.91/101F236 | * |



STAHL

| Maschinen-Typ Type/Type/Tipo | Abmessungen in mm Size/Dimension/Tamaño | Löcher/Holes Trous/Huecos | △ kg | FASSCO-Id. Qualität/Quality/Calid. | €/Stück Pce./Pce./Pza. |
|--|--|-------------------------------|---------|---------------------------------------|---------------------------|
| SM 100 Stanzen V-Fase Punch Cut V-Shape altes Modell old Model | Obermesser F242-064-00-11 05 F242-064-BG 01 362 x 95/76,2 x 6 | 5 Langlöcher 2/M12 4/M5 | 1,19 | 083.63/006F236 | * |
| | Obermesser F242-064-00-11 05 F242-064-BG 02 362 x 95/76,2 x 9 | 5 Langlöcher 2/M12 4/M5 | 1,72 | 083.63/009F236 | * |
| | Obermesser F242-064-00-11 05 F242-064-BG 03 362 x 95/76,2 x 12 | 5 Langlöcher 2/M12 4/M5 | 2,25 | 083.63/012F236 | * |
| | Untermesser, links F242-061-00-11 F242-061-01-00 406,5 x 24,7 x 12,7 | 5 zyl.vers. Langlöcher | 0,83 | 083.91/101F236 | * |
| | Untermesser, rechts F242-061-00-11 F242-061-01-00 406,5 x 24,7 x 12,7 | 5 zyl.vers. Langlöcher | 0,83 | 083.91/101F236 | * |

STAHL GAZEMESSER

| Maschinen-Typ Type/Type/Tipo | Abmessungen in mm Size/Dimension/Tamaño | Löcher/Holes Trous/Huecos | △ kg | FASSCO-Id. Qualität/Quality/Calid. | €/Stück Pce./Pce./Pza. |
|---------------------------------|---|------------------------------|---------|---------------------------------------|---------------------------|
| Gazestation | Obermesser 134389 083.0403.000 414 x 38 x 8 | 6 vers.Lö. | 0,9 | 083.70/001F236 | * |
| | Untermesser 142000 /134391 083.0407.100 415 x 70/55 x 10 | 7/8 Ø | 1,70 | 083.70/101F236 | * |

TECHMA



| Maschinen-Typ Type/Type/Tipo | Abmessungen in mm Size/Dimension/Tamaño | Löcher/Holes Trous/Huecos | ⚖ kg | FASSCO-Id. Qualität/Quality/Calid. | €/Stück Pce./Pce./Pza. |
|---------------------------------|--|------------------------------|---------|---------------------------------------|---------------------------|
| BR 67 | 780 x 100 x 10 | 5/M10 | 5,20 | 090.05F220 | * |
| | | | | 090.05F3000 | * |
| BR 72 | 900 x 150 x 14 | 14/M12 | 13,00 | 090.01F220 | * |
| | | | | 090.01F3000 | * |
| BR 82 | 1000 x 150 x 12 | 14/M12 4/Ø5,2 | 12,42 | 090.02F220 | * |
| | | | | 090.02F3000 | * |
| BR 112 | 1335 x 160 x 14 | 32/M12 | 20,65 | 090.04F220 | * |
| | | | | 090.04F3000 | * |
| BR 125 | 1500 x 160 x 14 | 27/M12 4/Ø6,2 | 23,20 | 090.06F220 | * |
| | | | | 090.06F3000 | * |
| BR 139 | 1550 x 160 x 14 | 30/M12 4/Ø6,2 | 23,90 | 090.07F220 | * |
| | | | | 090.07F3000 | * |
| BR 136 | 1600 x 160 x 14 | 30/M12 | 24,55 | 090.03F220 | * |
| | | | | 090.03F3000 | * |

TECHMA

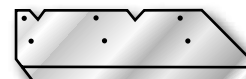
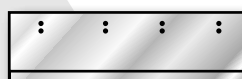

| Maschinen-Typ Type/Type/Tipo | Abmessungen in mm Size/Dimension/Tamaño | Löcher/Holes Trous/Huecos | ⚖ kg | FASSCO-Id. Qualität/Quality/Calid. | €/Stück Pce./Pce./Pza. |
|---------------------------------|--|------------------------------|---------|---------------------------------------|---------------------------|
| BRT-300 | Vordermesser 450 x 140 x 11 | 8/M12 | 4,85 | 090.90/001F220 | * |
| | | | | 090.90/001F3000 | * |
| | Seitenmesser, links 390 x 140 x 11 | 6/M12 | 3,70 | 090.90/002F220 | * |
| | | | | 090.90/002F3000 | * |
| | Seitenmesser, rechts 390 x 140 x 11 | 6/M12 | 3,70 | 090.90/003F220 | * |
| | | | | 090.90/003F3000 | * |
| €/Satz/Set/Jeu/Juego | | | | | |
| BRT-300 | kompletter Satz complete set | = 3 Messer = 3 knives | 12,25 | 090.90/300F220 | * |
| | | | | 090.90/300F3000 | * |

| Maschinen-Typ Type/Type/Tipo | Abmessungen in mm Size/Dimension/Tamaño | Löcher/Holes Trous/Huecos | ⚖ kg | FASSCO-Id. Qualität/Quality/Calid. | €/Stück Pce./Pce./Pza. |
|---------------------------------|--|------------------------------|---------|---------------------------------------|---------------------------|
| BRT | Vordermesser 600 x 140 x 12 | 8/M12x1,5 | 6,95 | 090.91/001F220 | * |
| | | | | 090.91/001F3000 | * |
| | Seitenmesser, links 430 x 140 x 12 | 3/M12x1,5 | 4,60 | 090.91/002F220 | * |
| | | | | 090.91/002F3000 | * |
| | Seitenmesser, rechts 430 x 140 x 12 | 3/M12x1,5 | 4,60 | 090.91/003F220 | * |
| | | | | 090.91/003F3000 | * |
| €/Satz/Set/Jeu/Juego | | | | | |
| BRT | kompletter Satz complete set | = 3 Messer = 3 knives | 16,15 | 090.91/300F220 | * |
| | | | | 090.91/300F3000 | * |



TECHMA

| Maschinen-Typ Type/Type/Tipo | Abmessungen in mm Size/Dimension/Tamaño | Löcher/Holes Trous/Huecos | ⚖️ kg | FASSCO-Id. Qualität/Quality/Calid. | €/Stück Pce./Pce./Pza. |
|---------------------------------|--|------------------------------|----------|---------------------------------------|---------------------------|
| BRT-125/450 | Vordermesser 560 x 140 x 12 | 8/M12 | 6,48 | 090.92/001F220 | * |
| | | | | 090.92/001F3000 | * |
| | Seitenmesser, links 512 x 140 x 12 | 6/M12 | 5,05 | 090.92/002F220 | * |
| | | | | 090.92/002F3000 | * |
| | Seitenmesser, rechts 512 x 140 x 12 | 6/M12 | 5,05 | 090.92/003F220 | * |
| | | | | 090.92/003F3000 | * |
| €/Satz/Set/Jeu/Juego | | | | | |
| BRT-125/450 | kompletter Satz complete set | = 3 Messer = 3 knives | 16,58 | 090.92/300F220 | * |
| | | | | 090.92/300F3000 | * |

| Maschinen-Typ Type/Type/Tipo | Abmessungen in mm Size/Dimension/Tamaño | Löcher/Holes Trous/Huecos | ⚖️ kg | FASSCO-Id. Qualität/Quality/Calid. | €/Stück Pce./Pce./Pza. |
|---------------------------------|--|------------------------------|----------|---------------------------------------|---------------------------|
| BRT | Vordermesser 560 x 140 x 12 | 8/M12 | 6,48 | 090.92/001F220 | * |
| | | | | 090.92/001F3000 | * |
| | Seitenmesser, links 483 x 140 x 12 | 6/M12 | 4,70 | 090.92/022F220 | * |
| | | | | 090.92/022F3000 | * |
| | Seitenmesser, rechts 483 x 140 x 12 | 6/M12 | 4,70 | 090.92/023F220 | * |
| | | | | 090.92/023F3000 | * |
| €/Satz/Set/Jeu/Juego | | | | | |
| BRT | kompletter Satz complete set | = 3 Messer = 3 knives | 15,88 | 090.92A/300F220 | * |
| | | | | 090.92A/300F3000 | * |

| Maschinen-Typ Type/Type/Tipo | Abmessungen in mm Size/Dimension/Tamaño | Löcher/Holes Trous/Huecos | ⚖️ kg | FASSCO-Id. Qualität/Quality/Calid. | €/Stück Pce./Pce./Pza. |
|---------------------------------|--|------------------------------|----------|---------------------------------------|---------------------------|
| BRT | Vordermesser 470 x 140 x 12 | 8/M12x1,5 | 5,40 | 090.93/001F220 | * |
| | | | | 090.93/001F3000 | * |
| | Seitenmesser, links 470 x 140 x 12 | 9/M12x1,5 | 4,65 | 090.93/002F220 | * |
| | | | | 090.93/002F3000 | * |
| | Seitenmesser, rechts 470 x 140 x 12 | 9/M12x1,5 | 4,65 | 090.93/003F220 | * |
| | | | | 090.93/003F3000 | * |
| €/Satz/Set/Jeu/Juego | | | | | |
| BRT | kompletter Satz complete set | = 3 Messer = 3 knives | 14,70 | 090.93/300F220 | * |
| | | | | 090.93/300F3000 | * |

THEISEN & BONITZ



| Maschinen-Typ Type/Type/Tipo | Abmessungen in mm Size/Dimension/Tamaño | Löcher/Holes Trous/Huecos | ⚖️ kg | FASSCO-Id. Qualität/Quality/Calid. | €/Stück Pce./Pce./Pza. |
|--|---|------------------------------|----------|---------------------------------------|---------------------------|
| Sprint 303/304 303S Quick Set Format max. 35x50/50x50 ab 7/88 | Obermesser 1000 2589-01 (303.05.18C) 425 x 75/65 x 6 | 14/8,5 Ø 2/M8 | 1,20 | 070.92/001F236 | 157,00 |
| | Untermesser 1000 2590-01 (303.05.19A) 425 x 40,5 x 15,2/10,1 | 5 vers.Lö. | 1,36 | 070.91/101F236 | 138,00 |

| Maschinen-Typ Type/Type/Tipo | Abmessungen in mm Size/Dimension/Tamaño | Löcher/Holes Trous/Huecos | ⚖️ kg | FASSCO-Id. Qualität/Quality/Calid. | €/Stück Pce./Pce./Pza. |
|---|--|------------------------------|----------|---------------------------------------|---------------------------|
| HFS altes Modell old Model | Obermesser 425 x 140/75/66 x 6 | 10/M6 1/7 Ø | 1,32 | 070.90/001F236 | * |
| | Untermesser 460 x 40 x 15/10 | 5 vers.Lö. | 1,45 | 070.90/101F236 | * |

| Maschinen-Typ Type/Type/Tipo | Abmessungen in mm Size/Dimension/Tamaño | Löcher/Holes Trous/Huecos | ⚖️ kg | FASSCO-Id. Qualität/Quality/Calid. | €/Stück Pce./Pce./Pza. |
|--|---|------------------------------|----------|---------------------------------------|---------------------------|
| Sprint 203/203S Quick Set Format max. 50x70/35x70 | Obermesser 1018 2007-02 (F5) (203.05.01B) 1018 2020-00 (F8) 575 x 75/65 x 6 | 18/8,5 Ø 2/M8 | 1,61 | 070.93/001F236 | * |
| | Untermesser 1018 2008-02 (F5) (203.05.02A) 1018 2021-00 (F8) 575 x 40,5 x 15,2/10,1 | 6 vers.Lö. | 1,91 | 070.93/101F236 | * |

| Maschinen-Typ Type/Type/Tipo | Abmessungen in mm Size/Dimension/Tamaño | Löcher/Holes Trous/Huecos | ⚖️ kg | FASSCO-Id. Qualität/Quality/Calid. | €/Stück Pce./Pce./Pza. |
|---|---|------------------------------|----------|---------------------------------------|---------------------------|
| Sprint 503 303/304 Kopf-Fuß- Beschnitt Head-Foot- Trimming Format max. 25x42,8 | Obermesser, links 105 04 004-01 300 x 65/56 x 6 | 14/M6 | 0,73 | 070.92/002F236 | 112,00 |
| | Obermesser, rechts 105 04 005-01 300 x 65/56 x 6 | 14/M6 | 0,73 | 070.92/003F236 | 112,00 |
| | Untermesser, links Standard 105 04 000-02 300 x 20 x 15/10 | 4/8,5 Ø | 0,50 | 070.92/102F236 | 117,00 |
| | Untermesser, rechts Standard 105 04 001-02 300 x 20 x 15/10 | 4/8,5 Ø | 0,50 | 070.92/103F236 | 117,00 |
| | Untermesser, links Sonderwerkzeug SW 50 105 04 070 300 x 17 x 15/10 | 4/6 Ø | 0,43 | 070.61/102F236 | 110,00 |
| | Untermesser, rechts Sonderwerkzeug SW 50 105 04 069 300 x 17 x 15/10 | 4/6 Ø | 0,43 | 070.61/103F236 | 110,00 |

| Maschinen-Typ Type/Type/Tipo | Abmessungen in mm Size/Dimension/Tamaño | Löcher/Holes Trous/Huecos | ⚖️ kg | FASSCO-Id. Qualität/Quality/Calid. | €/Stück Pce./Pce./Pza. |
|---|--|------------------------------|----------|---------------------------------------|---------------------------|
| 304/503 Kopf-Fuß- Beschnitt Head-Foot- Trimming kurz/short 270mm | Obermesser, links 105 04 079-7100 270 x 65/57,4 x 6 | 12/M6 | 0,65 | 070.92/006F236 | * |
| | Obermesser, rechts 105 04 080-7100 270 x 65/57,4 x 6 | 12/M6 | 0,65 | 070.92/007F236 | * |
| | Untermesser, links 105 04 081-02 (A) 270 x 17 x 15/10 | 3/6 Ø | 0,35 | 070.63/104F236 | * |
| | Untermesser, rechts 105 04 081-02 (B) 270 x 17 x 15/10 | 3/6 Ø | 0,35 | 070.63/105F236 | * |

| Maschinen-Typ Type/Type/Tipo | Abmessungen in mm Size/Dimension/Tamaño | Löcher/Holes Trous/Huecos | ⚖️ kg | FASSCO-Id. Qualität/Quality/Calid. | €/Stück Pce./Pce./Pza. |
|--|--|------------------------------|----------|---------------------------------------|---------------------------|
| Sprint 503 Kopf-Fuß- Beschnitt Head-Foot- Trimming SW50 320mm | Obermesser, links 105 04 079 (F5) 105 04 096-00 (F8) 320 x 65,3/55,7 x 6 | 14/M6 | 0,78 | 070.92/004F236 | 127,00 |
| | Obermesser, rechts 105 04 080 (F5) 105 04 097-00 (F8) 320 x 65,3/55,7 x 6 | 14/M6 | 0,78 | 070.92/005F236 | 127,00 |
| | Untermesser, links 105 04 082-01 320 x 17 x 15/10 | 4/6 Ø | 0,46 | 070.61/104F236 | 127,00 |
| | Untermesser, rechts 105 04 081-01 320 x 17 x 15/10 | 4/6 Ø | 0,46 | 070.61/105F236 | 127,00 |

THEISEN & BONITZ



| Maschinen-Typ Type/Type/Tipo | Abmessungen in mm Size/Dimension/Tamaño | Löcher/Holes Trous/Huecos | △ kg | FASSCO-Id. Qualität/Quality/Calid. | €/Stück Pce./Pce./Pza. |
|---------------------------------|---|------------------------------|---------|---------------------------------------|---------------------------|
| Seitenschnitt 370mm (4295) | Obermesser, links 10504079-4295-01 370 x 65/50 x 6 | 16/M6 | 0,88 | 070.93/002F236 | * |
| | Obermesser, rechts 10504080-4295-01 370 x 65/50 x 6 | 16/M6 | 0,88 | 070.93/003F236 | * |

THEISEN & BONITZ



| Maschinen-Typ Type/Type/Tipo | Abmessungen in mm Size/Dimension/Tamaño | Löcher/Holes Trous/Huecos | △ kg | FASSCO-Id. Qualität/Quality/Calid. | €/Stück Pce./Pce./Pza. |
|---|---|------------------------------|---------|---------------------------------------|---------------------------|
| Sprint 503 Stanzen V-Fase Punch cut V-Shape | Obermesser 105 04 061-01 300 x 69/60 x 5 | 7 Langlöcher | 0,69 | 070.60/005F236 | * |
| | Obermesser 105 04 003-04 300 x 69/60 x 6 | 7 Langlöcher | 0,80 | 070.60/006F236 | * |
| | Obermesser 105 04 002-03 300 x 69/60 x 8 | 7 Langlöcher | 1,05 | 070.60/008F236 | * |
| | Obermesser 105 04 077 300 x 69/60 x 10 | 7 Langlöcher | 1,33 | 070.60/010F236 | * |
| | Untermesser, links Standard 105 04 000-02 300 x 20 x 15/10 | 4/8,5 Ø | 0,50 | 070.92/102F236 | * |
| | Untermesser, rechts Standard 105 04 001-02 300 x 20 x 15/10 | 4/8,5 Ø | 0,50 | 070.92/103F236 | * |
| | Untermesser, links Sonderwerkzeug SW 50 105 04 070 300 x 17 x 15/10 | 4/6 Ø | 0,43 | 070.61/102F236 | * |
| | Untermesser, rechts Sonderwerkzeug SW 50 105 04 069 300 x 17 x 15/10 | 4/6 Ø | 0,43 | 070.61/103F236 | * |



THEISEN & BONITZ

| Maschinen-Typ Type/Type/Tipo | Abmessungen in mm Size/Dimension/Tamaño | Löcher/Holes Trous/Huecos | kg | FASSCO-Id. Qualität/Quality/Calid. | €/Stück Pce./Pce./Pza. |
|--|---|------------------------------|------|---------------------------------------|---------------------------|
| Sprint 304/503 Stanzen V-Fase Punch cut V-Shape | Obermesser 105 04 061-02 320 x 69/60 x 5 | 7 Langlöcher | 0,73 | 070.62/005F236 | * |
| | Obermesser 105 04 003-05 320 x 69/60 x 6 | 7 Langlöcher | 0,85 | 070.62/006F236 | * |
| | Obermesser 105 04 091-00 320 x 69/60 x 8 | 7 Langlöcher | 1,14 | 070.62/008F236 | * |
| | Obermesser 105 04 077-01 320 x 69/60 x 10 | 7 Langlöcher | 1,44 | 070.62/010F236 | * |
| | Untermesser, links 105 04 082-01 (10504081-02) 320 x 17 x 15/10 | 4/6 Ø | 0,46 | 070.61/104F236 | * |
| | Untermesser, rechts 105 04 081-01 (10504081-02) 320 x 17 x 15/10 | 4/6 Ø | 0,46 | 070.61/105F236 | * |

THEISEN & BONITZ

| Maschinen-Typ Type/Type/Tipo | Abmessungen in mm Size/Dimension/Tamaño | Löcher/Holes Trous/Huecos | kg | FASSCO-Id. Qualität/Quality/Calid. | €/Stück Pce./Pce./Pza. |
|---------------------------------|--|------------------------------|------|---------------------------------------|---------------------------|
| | Schneidschiene/Pressleiste 440 x 24,5 x 5,5 | 5/M5 | 0,45 | 070.50F236 | * |

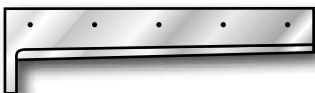

TMF SCHWENNINGEN

| Maschinen-Typ Type/Type/Tipo | Abmessungen in mm Size/Dimension/Tamaño | Löcher/Holes Trous/Huecos | kg | FASSCO-Id. Qualität/Quality/Calid. | €/Stück Pce./Pce./Pza. |
|---------------------------------|---|------------------------------|------|---------------------------------------|---------------------------|
| TMF 40 | Obermesser SM1-2-4 396 x 99/63/44 x 7,5 | 5/8,5 Ø | 1,07 | 101.90/001F236 | * |
| | Untermesser SM1-2-5 396 x 40 x 7,5/6,5 | 10 vers.Lö. | 0,80 | 101.90/101F236 | * |



TOROS

| Maschinen-Typ Type/Type/Tipo | Abmessungen in mm Size/Dimension/Tamaño | Löcher/Holes Trous/Huecos | kg | FASSCO-Id. Qualität/Quality/Calid. | €/Stück Pce./Pce./Pza. |
|---------------------------------|--|------------------------------|------|---------------------------------------|---------------------------|
| 72 | 900 x 120 x 8 | | 5,95 | 092.01F220 | * |
| | | | | 092.01F3000 | * |
| | 1050 x 120 x 10 | | 8,75 | 092.02F220 | * |
| | | | | 092.02F3000 | * |

Für alle TOROS-Typen ist eine Zeichnung erforderlich.
For all TOROS-types a drawing is required.

* Preis auf Anfrage / Price on request

www.fassco.de | 193

TOSINGRAF



| Maschinen-Typ Type/Type/Tipo | Abmessungen in mm Size/Dimension/Tamaño | Löcher/Holes Trous/Huecos | kg | FASSCO-Id. Qualität/Quality/Calid. | €/Stück Pce./Pce./Pza. |
|---------------------------------|--|------------------------------|-------|---------------------------------------|---------------------------|
| TGF 920 | 1118 x 128 x 12,6 | 16/M12 +MWE | 12,44 | 127.01F220 | * |
| | | | | 127.01F3000 | * |
| 115 (=FEIDA) | 1390 x 160 x 12,7 (115-01-21) | 22/M12 + MWE | 19,60 | 013.03F220 | * |
| | | | | 013.03F3000 | * |

| Maschinen-Typ Type/Type/Tipo | Abmessungen in mm Size/Dimension/Tamaño | Löcher/Holes Trous/Huecos | kg | FASSCO-Id. Qualität/Quality/Calid. | €/Stück Pce./Pce./Pza. |
|---------------------------------|--|------------------------------|-------|---------------------------------------|---------------------------|
| QS 420 | Vordermesser 492 x 126 x 12,65 | 8/M10 | 5,35 | 127.88/001F220 | * |
| | | | | 127.88/001F3000 | * |
| | Seitenmesser, links 422 x 126 x 12,65 | 8/M10 | 4,50 | 127.88/002F220 | * |
| | | | | 127.88/002F3000 | * |
| | Seitenmesser, rechts 422 x 126 x 12,65 | 8/M10 | 4,50 | 127.88/003F220 | * |
| | | | | 127.88/003F3000 | * |
| €/Satz/Set/Jeu/Juego | | | | | |
| QS 420 | kompletter Satz complete set | = 3 Messer = 3 knives | 14,35 | 127.88/300F220 | * |
| | | | | 127.88/300F3000 | * |

TRÄNKLEIN



| Maschinen-Typ Type/Type/Tipo | Abmessungen in mm Size/Dimension/Tamaño | Löcher/Holes Trous/Huecos | kg | FASSCO-Id. Qualität/Quality/Calid. | €/Stück Pce./Pce./Pza. |
|--|--|------------------------------|-------|---------------------------------------|---------------------------|
| DS III 57 K | 480 x 130 x 9 | 10/M12 | 3,90 | 012.01F220 | * |
| | | | | 012.01F3000 | * |
| DS III 58 | 695 x 130 x 9 | 12/M12 | 5,65 | 012.02F220 | * |
| | | | | 012.02F3000 | * |
| DS III 57 | 695/660 x 130 x 9 | 12/M12 | 5,55 | 012.03F220 | * |
| | | | | 012.03F3000 | * |
| SM 80 | 960 x 130 x 9 | 16/M12 | 7,80 | 012.04F220 | * |
| | | | | 012.04F3000 | * |
| SM 80 ab Masch.-Nr. T 2487/70/8 SM 86 | 1000 x 130 x 9 | 16/M12 | 8,10 | 012.05F220 | * |
| | | | | 012.05F3000 | * |
| SM 89 | 1040 x 130 x 9 | 16/M12 | 8,45 | 012.06F220 | * |
| | | | | 012.06F3000 | * |
| SM 92 | 1065 x 130 x 9 | 16/M12 | 8,65 | 012.10F220 | * |
| | | | | 012.10F3000 | * |
| SM 92 ab Serie 10/77 | 1065 x 130 x 9 | 18/M12 | 8,65 | 012.11F220 | * |
| | | | | 012.11F3000 | * |
| SM 115 | 1330 x 145 x 10 | 33/M12 | 13,30 | 012.08F220 | * |
| | | | | 012.08F3000 | * |

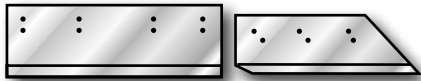

TRIMASS

| Maschinen-Typ Type/Type/Tipo | Abmessungen in mm Size/Dimension/Tamaño | Löcher/Holes Trous/Huecos | △ kg | FASSCO-Id. Qualität/Quality/Calid. | €/Stück Pce./Pce./Pza. |
|---------------------------------|--|------------------------------|---------|---------------------------------------|---------------------------|
| | Vordermesser 485 x 130 x 8 | 8/M12 | 3,50 | 022.90/001F220 | * |
| | | | | 022.90/001F3000 | * |
| | Seitenmesser, links 402 x 130 x 8 | 6/M12 | 2,50 | 022.90/002F220 | * |
| | | | | 022.90/002F3000 | * |
| | Seitenmesser, rechts 402 x 130 x 8 | 6/M12 | 2,50 | 022.90/003F220 | * |
| | | | | 022.90/003F3000 | * |
| €/Satz/Set/Jeu/Juego | | | | | |
| | kompletter Satz complete set | = 3 Messer = 3 knives | 8,50 | 022.90/300F220 | * |
| | | | | 022.90/300F3000 | * |

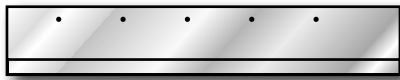

UCHIDA

(Morgana)

| Maschinen-Typ Type/Type/Tipo | Abmessungen in mm Size/Dimension/Tamaño | Löcher/Holes Trous/Huecos | △ kg | FASSCO-Id. Qualität/Quality/Calid. | €/Stück Pce./Pce./Pza. |
|---------------------------------|--|------------------------------|---------|---------------------------------------|---------------------------|
| 46 *) | 570 x 70 x 7 | 4/M10 | 1,90 | 085.05F220 | * |
| | | | | 085.05F3000 | * |
| 48 | 590 x 80 x 10 | 5/M10 | 3,20 | 085.06F220 | * |
| | | | | 085.06F3000 | * |
| 57 | 670 x 70 x 8 | 5/M10 | 2,60 | 085.01F220 | * |
| | | | | 085.01F3000 | * |
| 61 | 710 x 70 x 8 | 5/M10 | 2,75 | 085.02F220 | * |
| | | | | 085.02F3000 | * |
| 64 | 760 x 70 x 8 | 5/M10 | 2,95 | 085.04F220 | * |
| | | | | 085.04F3000 | * |
| 72 | 892 x 100 x 10 | 8/M10 | 6,25 | 085.03F220 | * |
| | | | | 085.03F3000 | * |

*) Für diese UCHIDA-Typen ist eine Zeichnung erforderlich. / *) For these UCHIDA -types a drawing is required.

ÜSTGÜL



| Maschinen-Typ Type/Type/Tipo | Abmessungen in mm Size/Dimension/Tamaño | Löcher/Holes Trous/Huecos | △ ⁺ kg | FASSCO-Id. Qualität/Quality/Calid. | €/Stück Pce./Pce./Pza. |
|---------------------------------|--|------------------------------|----------------------|---------------------------------------|---------------------------|
| KF 72 | 860 x 120 x 10 | | 7,15 | 096.05F220 | * |
| | | | | 096.05F3000 | * |
| KF 85 | 960 x 120 x 10 | | 7,95 | 096.01F220 | * |
| | | | | 096.01F3000 | * |
| | 1000 x 120 x 8 | | 6,72 | 096.06F220 | * |
| | | | | 096.06F3000 | * |
| AC/HF 85 | 1150 x 120 x 10 | | 9,55 | 096.02F220 | * |
| | | | | 096.02F3000 | * |
| HF 105 | 1250 x 120 x 10 | | 10,40 | 096.03F220 | * |
| | | | | 096.03F3000 | * |
| HF 115 | 1400 x 140 x 12 | | 16,30 | 096.04F220 | * |
| | | | | 096.04F3000 | * |

Für alle ÜSTGÜL-Typen ist eine Zeichnung erforderlich. / For all ÜSTGÜL-types a drawing is required.

VARIMEX



| Maschinen-Typ Type/Type/Tipo | Abmessungen in mm Size/Dimension/Tamaño | Löcher/Holes Trous/Huecos | △ ⁺ kg | FASSCO-Id. Qualität/Quality/Calid. | €/Stück Pce./Pce./Pza. |
|---------------------------------|--|------------------------------|----------------------|---------------------------------------|---------------------------|
| K 525 | 606 x 98 x 9,8 | 5/M10 | 4,10 | 068.01F220 | * |
| | | | | 068.01F3000 | * |
| K 650 | 750 x 98 x 9,8 | 5/M10 | 5,00 | 068.02F220 | * |
| | | | | 068.02F3000 | * |
| KRH 76 | 970 x 130 x 9,5 | 12/M12x1,5 | 8,40 | 068.03F220 | * |
| | | | | 068.03F3000 | * |
| KRH 115 | 1347 x 140 x 12 | 24/M12x1,5 | 15,60 | 068.04F220 | * |
| | | | | 068.04F3000 | * |

VICTORY-KIDDER



| Maschinen-Typ Type/Type/Tipo | Abmessungen in mm Size/Dimension/Tamaño | Löcher/Holes Trous/Huecos | △ ⁺ kg | FASSCO-Id. Qualität/Quality/Calid. | €/Stück Pce./Pce./Pza. |
|---------------------------------|---|------------------------------|----------------------|---------------------------------------|---------------------------|
| 26 1/2" *) | 806,45 x 125,4 x 9,9 31.3/4" x 4.15/16" x .390" | 16 1/2"BSF | 6,92 | 071.02F220 | * |
| | | | | 071.02F3000 | * |
| V1 30.7 | 940 x 127,8 x 9,4 37" x 5.1/32" x .370" | 16 1/2"BSF | 7,82 | 071.03F220 | * |
| | | | | 071.03F3000 | * |
| V6 32.5 CAMCO 825 | 1016 x 125,4 x 9,9 40" x 4.15/16" x .390" | 20 1/2"BSF | 8,70 | 071.01F220 | * |
| | | | | 071.01F3000 | * |
| CAMCO 920 MP | 1117,6 x 125,4 x 9,9 44" x 4.15/16" x .390" | 20 1/2"BSF | 9,60 | 071.04F220 | * |
| | | | | 071.04F3000 | * |
| V8 ASP 42" *) | 1257,3 x 125,4 x 12,6 49.1/2" x 4.15/16" x .496" | 24 1/2"BSF | 13,70 | 071.05F220 | * |
| | | | | 071.05F3000 | * |

*) Für diese Victory-Kidder-Typen ist eine Zeichnung erforderlich.

*) For these Victory-Kidder -types a drawing is required.

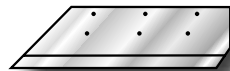

VICTORY-KIDDER (JOHNE)

| Maschinen-Typ Type/Type/Tipo | Abmessungen in mm Size/Dimension/Tamaño | Löcher/Holes Trous/Huecos | ⚖️ kg | FASSCO-Id. Qualität/Quality/Calid. | €/Stück Pce./Pce./Pza. |
|---------------------------------|--|------------------------------|----------|---------------------------------------|---------------------------|
| 25/35 JOHNE | Vordermesser 475 x 128 x 8 | 8 1/2" BSF | 3,35 | 071.92/001F220 | * |
| | | | | 071.92/001F3000 | * |
| | Seitenmesser, links 400 x 128 x 8 | 6 1/2" BSF | 2,45 | 071.92/002F220 | * |
| | | | | 071.92/002F3000 | * |
| | Seitenmesser, rechts 400 x 128 x 8 | 6 1/2" BSF | 2,45 | 071.92/003F220 | * |
| | | | | 071.92/003F3000 | * |
| €/Satz/Set/Jeu/Juego | | | | | |
| 25/35 JOHNE | kompletter Satz complete set | = 3 Messer = 3 knives | 8,25 | 071.92/300F220 | * |
| | | | | 071.92/300F3000 | * |

| Maschinen-Typ Type/Type/Tipo | Abmessungen in mm Size/Dimension/Tamaño | Löcher/Holes Trous/Huecos | ⚖️ kg | FASSCO-Id. Qualität/Quality/Calid. | €/Stück Pce./Pce./Pza. |
|--|--|------------------------------|----------|---------------------------------------|---------------------------|
| Dreischneider Three knife trim. | Vordermesser 585 x 128 x 10 | 10 1/2" BSF | 5,20 | 071.90/001F220 | * |
| | | | | 071.90/001F3000 | * |
| | Seitenmesser, links 450 x 128 x 10 | 6 1/2" BSF | 3,50 | 071.90/002F220 | * |
| | | | | 071.90/002F3000 | * |
| | Seitenmesser, rechts 450 x 128 x 10 | 6 1/2" BSF | 3,50 | 071.90/003F220 | * |
| | | | | 071.90/003F3000 | * |
| €/Satz/Set/Jeu/Juego | | | | | |
| Dreischneider Three knife trim. | kompletter Satz complete set | = 3 Messer = 3 knives | 12,20 | 071.90/300F220 | * |
| | | | | 071.90/300F3000 | * |

WOHLENBERG



| Maschinen-Typ Type/Type/Tipo | Abmessungen in mm Size/Dimension/Tamaño | Löcher/Holes Trous/Huecos | kg | FASSCO-Id. Qualität/Quality/Calid. | €/Stück Pce./Pce./Pza. |
|--|--|------------------------------|-------|---------------------------------------|---------------------------|
| 62 digi-cut (= Maxima) | 737 x 140 x 12 530-02-002 530-03-060 | 14/M12 | 8,55 | 004.27F220 | 310,00 |
| | | | | 004.27F3000 | 416,00 |
| A 76 GW | 900 x 100 x 10 5003506 (F2) 5028674 (F8) | 12/M12 | 6,05 | 004.20F220 | 213,00 |
| | | | | 004.20F3000 | 295,00 |
| A 76 F/G A 76 S/SP/SPM A 76 cut-tec | 900 x 100 x 10 5022031 (F2) 5034686 (F3) 5028674 (F8) | 16/M12 | 6,00 | 004.23F220 | 213,00 |
| | | | | 004.23F3000 | 295,00 |
| A 76 K ab Fo. 3769 | 910 x 100 x 10 5309043 (F2) 5100586 (F3) | 16/M12 | 6,10 | 004.28F220 | 218,00 |
| | | | | 004.28F3000 | 299,00 |
| WB P 76 ab 2009 | 935 x 110 x 11,7 48.22.063 3232871 F-8000 s. sep. Tabelle – s. sep. table | 14/M12 +MWE | 8,05 | 004.32F220 | 246,00 |
| | | | | 004.32F3000 | 317,00 |
| A 78 GW | 920 x 100 x 10 | 12/M12 | 6,15 | 004.26F220 | * |
| | | | | 004.26F3000 | * |
| W 80 | 966 x 140 x 1 | 24/M12 +MWE | 12,25 | 004.41F220 | 406,00 |
| | | | | 004.41F3000 | 516,00 |
| A 78 Cg | 970 x 130 x 10,75 | 7/M12 | 9,25 | 004.01F220 | * |
| | | | | 004.01F3000 | * |
| A 86/87 S < 1960 | 1010 x 130 x 11,95 7003358 (F2) | 9/M12 | 10,08 | 004.03F220 | * |
| | | | | 004.03F3000 | * |
| A 86/88 T A 90 PT | 1070 x 125 x 12 7004487 (F2) 5003159 | 10/M12 | 11,05 | 004.05F220 | 341,00 |
| | | | | 004.05F3000 | 491,00 |
| A 92 G/ MCS A 92 SPM (EH 110) bis Fo. 3375 | 1080 x 120 x 12 5028865 (F2) 5031199 (F2) 5031201 (F8) | 22/M12 | 10,40 | 004.24F220 | 319,00 |
| | | | | 004.24F3000 | 464,00 |
| A 92 G/SP/SPM A 92 MC/MCS A 92 MCS-2TV cut-tec (EH 120) ab Fo. 3376 | 1090 x 120 x 12 5032553 (F2) 5034706 (F3) 5032555 (F8) | 22/M12 | 10,50 | 004.25F220 | 319,00 |
| | | | | 004.25F3000 | 464,00 |
| 92 F/Pro./T 90 F ab Fo. 2964 bis Fo. 3224 | 1100 x 125 x 12 7004000 (F2) | 11/M12 | 11,30 | 004.19F220 | 331,00 |
| | | | | 004.19F3000 | 481,00 |
| 92 K cut-tec ab Fo. 3811 | 1110 x 130 x 14 (5101069) (5101756) (5102174) | 22/M12 | 13,90 | 004.29F220 | 380,00 |
| | | | | 004.29F3000 | 530,00 |
| WB P 92 ab 2009 | 1085 x 140 x 13 48.22.081 3232872 F-8000 s. sep. Tabelle – s. sep. table | 24/M12 +MWE | 13,45 | 004.33F220 | 406,00 |
| | | | | 004.33F3000 | 516,00 |
| A 106 S A 107 S/Sh | 1210 x 160 x 13,75 | 22/M12 | 18,45 | 004.06F220 | * |
| | | | | 004.06F3000 | * |
| A 105 Cg A 106 Dne | 1240 x 130 x 10,75 | 11/M12 | 11,90 | 004.04F220 | * |
| | | | | 004.04F3000 | * |

| Maschinen-Typ Type/Type/Tipo | Abmessungen in mm Size/Dimension/Tamaño | Löcher/Holes Trous/Huecos | kg | FASSCO-Id. Qualität/Quality/Calid. | €/Stück Pce./Pce./Pza. |
|--|--|--|-------|---------------------------------------|---------------------------|
| A 107 E/T/PN Standard Programmatic | 1280 x 140 x 13,75 192.43D1 7003590 (F2) | 13/M12 | 17,00 | 004.07F220 | * |
| | | | | 004.07F3000 | * |
| A 112 F A 115 T/Pr. bis Fo. 2988 | 1340 x 125 x 12 292.43D1 7003314 (F2) 7006142 (F8) | 13/M12 | 13,65 | 004.09F220 | 364,00 |
| | | | | 004.09F3000 | 532,00 |
| 115 F/ MCS 115 MCS-2TV 115 cut-tec PS ab Fo. 2989 | 1380 x 125 x 12 5031330 (F2) 5035737 (F3) 5032028 (F8) | 14/M12 + MWE | 14,15 | 004.18F220 | 354,00 |
| | | | | 004.18F3000 | 522,00 |
| 115 L 115 Pro-tec | 1380 x 140 x 14 5104069 (F2) 5103169 (F3) | 28/M12 + MWE | 18,65 | 004.30F220 | 500,00 |
| | | | | 004.30F3000 | 670,00 |
| WB P 115 TS ab 2009 + Drupa 2012 | 1350 x 140 x 12 48.22.040-1 3232713 F-8000 s. sep.Tabelle – s. sep. table | 30/M12x1,5 +MWE alt&neu old& new qu.change | 15,55 | 004.38F220 | 427,00 |
| | | | | 004.38F3000 | 640,00 |
| A 132 S | 1525 x 160 x 13,75 | 22/M12 | 23,30 | 004.10F220 | * |
| | | | | 004.10F3000 | * |
| A 132 U/T Standard Programmatic | 1570 x 140 x 13,75 242.43D3 7004323 (F2) | 15/M12 | 20,80 | 004.11F220 | * |
| | | | | 004.11F3000 | * |
| A 132 F | 1580 x 125 x 12 7004356 (F2) 5104128 (F8) | 16/M12 | 16,25 | 004.12F220 | * |
| | | | | 004.12F3000 | * |
| WB P 132 TS ab 2009 + Drupa 2012 | 1515 x 140 x 12 48.22.037-1 3232714 F-8000 s. sep.Tabelle – s. sep. table | 30/M12x1,5 +MWE alt&neu old& new qu.change | 17,40 | 004.39F220 | 469,00 |
| | | | | 004.39F3000 | 700,00 |
| 137 F/ MCS 137 MCS-2TV 137 cut-tec ab Fo. 3089 | 1595 x 125 x 12 5031895 (F2) 5033795 (F3) 5032031 (F8) | 16/M12 + MWE | 16,40 | 004.21F220 | 448,00 |
| | | | | 004.21F3000 | 625,00 |
| 137 L 137 Pro-tec | 1608 x 140 x 14 5104979 (F2) 5104976 (F3) | 32/M12 + MWE | 21,75 | 004.31F220 | 590,00 |
| | | | | 004.31F3000 | 835,00 |
| A 146 A 150 F | 1720 x 140 x 14 342.43D1 7003532 5030712 | 17/M12 | 22,85 | 004.13F220 | 640,00 |
| | | | | 004.13F3000 | 920,00 |
| 155 F /SPM 155 MCS-2TV 155 cut-tec PS ab Fo. 2970 | 1780 x 140 x 14 5032034 (F2) 5036162 5032034 | 18/M12 + MWE | 23,65 | 004.17F220 | 630,00 |
| | | | | 004.17F3000 | 910,00 |
| A 165 S/Sh Standard Programmatic | 1870 x 180 x 16,75 72.43D1 | 36/M12 | 39,20 | 004.14F220 | * |
| | | | | 004.14F3000 | * |

WOHLENBERG



| Maschinen-Typ Type/Type/Tipo | Abmessungen in mm Size/Dimension/Tamaño | Löcher/Holes Trous/Huecos | △ kg | FASSCO-Id. Qualität/Quality/Calid. | €/Stück Pce./Pce./Pza. |
|--|--|--|---------|---------------------------------------|---------------------------|
| A 165 U A 168 T | 1920 x 140 x 16,75 | 19/M12 | 31,10 | 004.15F220 | 914,00 |
| | 272.43D1 7004386 | | | 004.15F3000 | 1.310,00 |
| WB P 168 TS ab 2009 + Drupa 2012 | 1880 x 160 x 14 48.22.011-1 3232715 | 45/M12 +MWE alt&neu old& new qu.change | 28,85 | 004.40F220 | 820,00 |
| | F-8000 s. sep.Tabelle – s. sep. table | | | 004.40F3000 | 1.180,00 |
| A 180 F | 2055 x 160 x 16 7005808 5015819 | 20/M12 | 36,30 | 004.08F220 | 970,00 |
| | | | | 004.08F3000 | 1.350,00 |
| A 185 F A 185 MCS ab Fo. 3211 | 2105 x 160 x 16 5032036 (F2) 5037322 / 5032038 | 20/M12 + MWE | 37,25 | 004.22F220 | 960,00 |
| | | | | 004.22F3000 | 1.340,00 |
| A 220 U | 2430 x 160 x 16 222.43D1 / 7004660 | 24/M12 | 43,00 | 004.16F220 | 1.150,00 |
| | | | | 004.16F3000 | 1.670,00 |
| WB P 225 TS ab 2009 | 2450 x 160 x 14 48.22.014 / 3232876 | 57/M12 +MWE | 38,15 | 004.37F220 | 1.130,00 |
| | F-8000 s. sep.Tabelle – s. sep. table | | | 004.37F3000 | 1.650,00 |

WOHLENBERG

– HARTMETALL – TUNGSTEN CARBIDE (TCT) – CARBURE – METAL DURO –

| Maschinen-Typ Type/Type/Tipo | Abmessungen in mm Size/Dimension/Tamaño | Löcher/Holes Trous/Huecos | △ kg | FASSCO-Id. Qualität/Quality/Calid. | €/Stück Pce./Pce./Pza. |
|--|--|---|---------|---------------------------------------|---------------------------|
| WB P 76 ab 2009 | 935 x 95 x 11,7 48.22.062 | 7/M12 +MWE | 7,30 | 004.44F8000 | * |
| | | | | 004.44F8020 | * |
| | | | | 004.44F8040 | * |
| WB P 92 ab 2009 | 1085 x 105 x 13 48.22.080 | 8/M12 +MWE | 10,40 | 004.45F8000 | * |
| | | | | 004.45F8020 | * |
| | | | | 004.45F8040 | * |
| WB P 115 TS ab/from 2009 +Drupa 2012 | 1350 x 140 x 12 48.22.041-1 3232783 | 20/M12x1,5 +MWE alt&neu old&new qu.change | 15,55 | 004.52F8000 | * |
| | | | | 004.52F8020 | * |
| | | | | 004.52F8040 | * |
| WB P 132 TS ab/from 2009 +Drupa 2012 | 1515 x 140 x 12 48.22.038-1 3232784 | 20/M12x1,5 +MWE alt&neu old&new qu.change | 17,40 | 004.53F8000 | * |
| | | | | 004.53F8020 | * |
| | | | | 004.53F8040 | * |
| WB P 168 TS ab/from 2009 +Drupa 2012 | 1880 x 160 x 14 48.22.012-1 3232785 | 30/M12 +MWE alt&neu old&new qu.change | 28,85 | 004.54F8000 | * |
| | | | | 004.54F8020 | * |
| | | | | 004.54F8040 | * |
| WB P 225 TS ab/from 2009 | 2450 x 160 x 14 | 38/M12 +MWE | 38,15 | 004.49F8000 | * |
| | | | | 004.49F8020 | * |
| | | | | 004.49F8040 | * |



WOHLENBERG

| Maschinen-Typ Type/Type/Tipo | Abmessungen in mm Size/Dimension/Tamaño | Löcher/Holes Trous/Huecos | ⚖️ kg | FASSCO-Id. Qualität/Quality/Calid. | €/Stück Pce./Pce./Pza. |
|---------------------------------|---|------------------------------|----------|---------------------------------------|---------------------------|
| 38 F 38 FS 30 | Vordermesser 500 x 115 x 10 5010399 | 12/M12 | 3,75 | 004.94/001F220 | 148,00 |
| | | | | 004.94/001F3000 | 182,00 |
| | Seitenmesser, links 424 x 115 x 10 5003692 | 10/M12 | 3,10 | 004.90/023F220 | 130,00 |
| | | | | 004.90/023F3000 | 145,00 |
| | Seitenmesser, rechts 424 x 115 x 10 5003692 | 10/M12 | 3,10 | 004.90/023F220 | 130,00 |
| | | | | 004.90/023F3000 | 145,00 |
| €/Satz/Set/Jeu/Juego | | | | | |
| 38 F 38 FS 30 | kompletter Satz complete set | = 3 Messer = 3 knives | 9,95 | 004.91/300F220 | 408,00 |
| | | | | 004.91/300F3000 | 472,00 |

| Maschinen-Typ Type/Type/Tipo | Abmessungen in mm Size/Dimension/Tamaño | Löcher/Holes Trous/Huecos | ⚖️ kg | FASSCO-Id. Qualität/Quality/Calid. | €/Stück Pce./Pce./Pza. |
|--|---|------------------------------|----------|---------------------------------------|---------------------------|
| A 43/30A 43 Do/Dm/E 44 F/FO/FM 44 FM 50/ 40 44 FS 50/ 56 44 FS 30 O Trim-tec 45 i 56 i 60 i | Vordermesser 560 x 115 x 10 5003693 | 12/M12 | 4,20 | 004.90/001F220 | 148,00 |
| | | | | 004.90/001F3000 | 182,00 |
| | Seitenmesser, links 424 x 115 x 10 5003692 | 10/M12 | 3,10 | 004.90/023F220 | 130,00 |
| | | | | 004.90/023F3000 | 145,00 |
| | Seitenmesser, rechts 424 x 115 x 10 5003692 | 10/M12 | 3,10 | 004.90/023F220 | 130,00 |
| | | | | 004.90/023F3000 | 145,00 |
| €/Satz/Set/Jeu/Juego | | | | | |
| A 43/30 A A 44 /A45 44 F 50/56/30 Trim-tec 45 /56 /60 i | kompletter Satz complete set | = 3 Messer = 3 knives | 10,40 | 004.90/300F220 | 408,00 |
| | | | | 004.90/300F3000 | 472,00 |

| Maschinen-Typ Type/Type/Tipo | Abmessungen in mm Size/Dimension/Tamaño | Löcher/Holes Trous/Huecos | ⚖️ kg | FASSCO-Id. Qualität/Quality/Calid. | €/Stück Pce./Pce./Pza. |
|---------------------------------|---|------------------------------|----------|---------------------------------------|---------------------------|
| 44 FS 100 75 I Standard | Vordermesser 500 x 115 x 10 5010399 | 12/M12 | 3,75 | 004.94/001F220 | 148,00 |
| | | | | 004.94/001F3000 | 182,00 |
| | Seitenmesser, links 390 x 115 x 10 5010367 | 10/M12 | 2,55 | 004.94/023F220 | 140,00 |
| | | | | 004.94/023F3000 | 155,00 |
| | Seitenmesser, rechts 390 x 115 x 10 5010367 | 10/M12 | 2,55 | 004.94/023F220 | 140,00 |
| | | | | 004.94/023F3000 | 155,00 |
| €/Satz/Set/Jeu/Juego | | | | | |
| 44 FS 100 75 I Standard | kompletter Satz complete set | = 3 Messer = 3 knives | 8,85 | 004.94/300F220 | 428,00 |
| | | | | 004.94/300F3000 | 492,00 |

WOHLENBERG



| Maschinen-Typ Type/Type/Tipo | Abmessungen in mm Size/Dimension/Tamaño | Löcher/Holes Trous/Huecos | ⚖️ kg | FASSCO-Id. Qualität/Quality/Calid. | €/Stück Pce./Pce./Pza. |
|--|--|------------------------------|----------|---------------------------------------|---------------------------|
| 75 I Schwingschnitt Swing cut rim-tec 90 e | Vordermesser 500 x 115 x 10 (5010399) (5035547) (5037829) (5103373) | 12/M12 | 3,75 | 004.94/001F220 | 148,00 |
| | | | | 004.94/001F3000 | 182,00 |
| | Seitenmesser, links 424 x 115 x 10 (5037826) (5037828) (5103370) | 10/M12 | 2,70 | 004.95/004F220 | 150,00 |
| | | | | 004.95/004F3000 | 165,00 |
| | Seitenmesser, rechts 424 x 115 x 10 (5037825) (5037827) (5103369) | 10/M12 | 2,70 | 004.95/005F220 | 150,00 |
| | | | | 004.95/005F3000 | 165,00 |
| €/Satz/Set/Jeu/Juego | | | | | |
| 75 I Schwingschnitt Swing cut Trim-tec 90 e | kompletter Satz complete set | = 3 Messer = 3 knives | 9,15 | 004.95/300F220 | 448,00 |
| | | | | 004.95/300F3000 | 512,00 |

| Maschinen-Typ Type/Type/Tipo | Abmessungen in mm Size/Dimension/Tamaño | Löcher/Holes Trous/Huecos | ⚖️ kg | FASSCO-Id. Qualität/Quality/Calid. | €/Stück Pce./Pce./Pza. |
|---|---|------------------------------|----------|---------------------------------------|---------------------------|
| 75 I Schwingschnitt für Format A3 Swing cut for size A3 | Vordermesser 540 x 115 x 10 (5103375) | 12/M12 | 4,00 | 004.95/001F220 | 196,00 |
| | | | | 004.95/001F3000 | 216,00 |

| Maschinen-Typ Type/Type/Tipo | Abmessungen in mm Size/Dimension/Tamaño | Löcher/Holes Trous/Huecos | ⚖️ kg | FASSCO-Id. Qualität/Quality/Calid. | €/Stück Pce./Pce./Pza. |
|---------------------------------|--|------------------------------|----------|---------------------------------------|---------------------------|
| A 43/ 44FM50 kurz/short | Vordermesser 380 x 115 x 10 | 6/M12 | 2,90 | 004.93/001F220 | * |
| | | | | 004.93/001F3000 | * |
| | Seitenmesser, links 300 x 115 x 10 | 6/M12 | 2,30 | 004.93/023F220 | * |
| | | | | 004.93/023F3000 | * |
| | Seitenmesser, rechts 300 x 115 x 10 | 6/M12 | 2,30 | 004.93/023F220 | * |
| | | | | 004.93/023F3000 | * |
| €/Satz/Set/Jeu/Juego | | | | | |
| A 43/ 44FM50 kurz/short | kompletter Satz complete set | = 3 Messer = 3 knives | 7,50 | 004.93/300F220 | * |
| | | | | 004.93/300F3000 | * |



WOHLENBERG

| Maschinen-Typ Type/Type/Tipo | Abmessungen in mm Size/Dimension/Tamaño | Löcher/Holes Trous/Huecos | kg | FASSCO-Id. Qualität/Quality/Calid. | €/Stück Pce./Pce./Pza. |
|---------------------------------|---|------------------------------|-------|---------------------------------------|---------------------------|
| 44 F lang/long | Vordermesser 560 x 115 x 10 (5003693) | 12/M12 | 4,20 | 004.90/001F220 | * |
| | | | | 004.90/001F3000 | * |
| | Seitenmesser, links 444 x 115 x 10 (7003249) | 10/M12 | 3,25 | 004.92/023F220 | * |
| | | | | 004.92/023F3000 | * |
| | Seitenmesser, rechts 444 x 115 x 10 (7003249) | 10/M12 | 3,25 | 004.92/023F220 | * |
| | | | | 004.92/023F3000 | * |
| €/Satz/Set/Jeu/Juego | | | | | |
| 44 F lang/long | kompletter Satz complete set | = 3 Messer = 3 knives | 10,70 | 004.92/300F220 | * |
| | | | | 004.92/300F3000 | * |



WOHLENBERG GAZEMESSER

| Maschinen-Typ Type/Type/Tipo | Abmessungen in mm Size/Dimension/Tamaño | Löcher/Holes Trous/Huecos | kg | FASSCO-Id. Qualität/Quality/Calid. | €/Stück Pce./Pce./Pza. |
|---------------------------------|--|------------------------------|------|---------------------------------------|---------------------------|
| Gazestation 115 | Messerbalken m.Nase 6129825 62115-02701-01-007.0 470 x 55/31 x 10 | 5/M6 | 1,10 | 450.0405.700.F236 | * |
| | Messer 6129823 62115-02701-01-005.0 475 x 40 x 6 | 4 zyl.vers. Langlö. | 0,80 | 450.0404.102.F236 | * |
| | Messerträger 6129824 62115-02701-01-006.0 498,5 x 30 x 20 | 5 vers.Lö. 4/M8 | 2,30 | 450.0403.700.F146 | * |
| Gazestation 121 | Messerbalken m.Nase 6135510 62121-02701-01-024.0 550 x 55/31 x 10 | 6/M6 | 1,20 | 450.0505.700.F236 | * |
| | Messer 6135504 62121-02701-01-023.0 555 x 40 x 6 | 5 zyl.vers. Langlö. | 0,95 | 450.0504.102.F236 | * |
| | Messerträger 6135511 62121-02701-01-025.0 578,5 x 30 x 20 | 6 vers.Lö. 4/M8 | 2,70 | 450.0503.700.F146 | * |
| Gazestation 106 | Messerbalken m.Nase 6106772 62106-02701-01-093.1 540 x 70/36 x 10 | 5/M8 | 1,45 | 450.0507.700.F236 | * |
| | Messer 6001366 62106-02701-03-004.0 521 x 40 x 6,5 | 5 zyl.vers. Langlö. | 0,95 | 450.0504.103.F236 | * |

YASHAMOTO



| Maschinen-Typ Type/Type/Tipo | Abmessungen in mm Size/Dimension/Tamaño | Löcher/Holes Trous/Huecos | △ ⁺ kg | FASSCO-Id. Qualität/Quality/Calid. | €/Stück Pce./Pce./Pza. |
|---------------------------------|--|------------------------------|----------------------|---------------------------------------|---------------------------|
| 115 | 1350 x 154 x 12,6 | 22/M12 | 18,30 | 098.01F220 | * |
| | | | | 098.01F3000 | * |

Andere Messer auf Anfrage.
Other knives available on request.

YOSHINO



| Maschinen-Typ Type/Type/Tipo | Abmessungen in mm Size/Dimension/Tamaño | Löcher/Holes Trous/Huecos | △ ⁺ kg | FASSCO-Id. Qualität/Quality/Calid. | €/Stück Pce./Pce./Pza. |
|---------------------------------------|--|------------------------------|----------------------|---------------------------------------|---------------------------|
| Dreischneider Three knife trim. | Vordermesser 460 x 130 x 11 | 6 – 3/8"W | 4,55 | 109.89/001F220 | * |
| | | | | 109.89/001F3000 | * |
| | Seitenmesser, links 400 x 130 x 11 | 6 – 3/8"W | 3,95 | 109.89/023F220 | * |
| | | | | 109.89/023F3000 | * |
| | Seitenmesser, rechts 400 x 130 x 11 | 6 – 3/8"W | 3,95 | 109.89/023F220 | * |
| | | | | 109.89/023F3000 | * |
| €/Satz/Set/Jeu/Juego | | | | | |
| Dreischneider Three knife trim. | kompletter Satz complete set | = 3 Messer = 3 knives | 12,45 | 109.89/300F220 | * |
| | | | | 109.89/300F3000 | * |

| Maschinen-Typ Type/Type/Tipo | Abmessungen in mm Size/Dimension/Tamaño | Löcher/Holes Trous/Huecos | △ ⁺ kg | FASSCO-Id. Qualität/Quality/Calid. | €/Stück Pce./Pce./Pza. |
|---|--|------------------------------|----------------------|---------------------------------------|---------------------------|
| Modell 121 Einmesser- Dreischneider | Vordermesser 460 x 90 x 11 | 12/M10 | 2,80 | 109.90/001F3000 | * |
| | Seitenmesser, links 460 x 90 x 11 | 12/M10 | 2,80 | 109.90/001F3000 | * |
| | Seitenmesser, rechts 460 x 90 x 11 | 12/M10 | 2,80 | 109.90/001F3000 | * |
| €/Satz/Set/Jeu/Juego | | | | | |
| Modell 121 Einmesser- Dreischneider | kompletter Satz complete set | = 3 Messer = 3 knives | 8,40 | 109.90/300F3000 | * |

| Maschinen-Typ Type/Type/Tipo | Abmessungen in mm Size/Dimension/Tamaño | Löcher/Holes Trous/Huecos | △ ⁺ kg | FASSCO-Id. Qualität/Quality/Calid. | €/Stück Pce./Pce./Pza. |
|---|--|------------------------------|----------------------|---------------------------------------|---------------------------|
| YST 2700 Einmesser- Dreischneider | Vordermesser 460 x 90 x 11 | 16/M10 | 2,80 | 109.92/001F3000 | * |
| | Seitenmesser, links 460 x 90 x 11 | 16/M10 | 2,80 | 109.92/001F3000 | * |
| | Seitenmesser, rechts 460 x 90 x 11 | 16/M10 | 2,80 | 109.92/001F3000 | * |
| €/Satz/Set/Jeu/Juego | | | | | |
| YST 2700 Einmesser- Dreischneider | kompletter Satz complete set | = 3 Messer = 3 knives | 8,40 | 109.92/300F3000 | * |

Für alle YOSHINO-Typen ist eine Zeichnung erforderlich.
For all YOSHINO -types a drawing is required.

SCHNEIDLEISTEN CUTTING STICKS



ADAST-MAXIMA

| Maschinen-Type Type/Type/Tipo | Abmessungen in mm Size/Dimension/Tamaño | △ kg | FASSCO Nr./No. | €/Stück Pce./Pce./Pza. |
|----------------------------------|--|---------|-------------------|---------------------------|
| 58 | 580 x 14 x 14 | 0,159 | 2024.0114.002 | 4,15 |
| 80 | 820 x 14 x 14 | 0,225 | 2024.0214.002 | 5,90 |
| 80 | 820 x 20 x 20 | 0,459 | 2024.0220.002 | 11,60 |
| 106 | 1060 x 20 x 20 | 0,594 | 2024.0520.002 | 15,00 |

ATLAS

| Maschinen-Type Type/Type/Tipo | Abmessungen in mm Size/Dimension/Tamaño | △ kg | FASSCO Nr./No. | €/Stück Pce./Pce./Pza. |
|----------------------------------|--|---------|-------------------|---------------------------|
| A 78 Z/ 80 Y/Z | 805 x 15 x 4 | 0,068 | 2001.0115.402 | 3,15 |
| A 106 Z | 1065 x 15 x 4 | 0,089 | 2001.0315.402 | 4,15 |
| A 132 Z | 1325 x 15 x 4 | 0,111 | 2001.0415.402 | 5,20 |
| A 152 Z | 1525 x 15 x 4 | 0,128 | 2001.0515.402 | 5,95 |
| 25/35 | 1100 x 13 x 3 | 0,060 | 2001.9013.302 | 3,40 |

BLUMER-ATLAS

| Maschinen-Type Type/Type/Tipo | Abmessungen in mm Size/Dimension/Tamaño | △ kg | FASSCO Nr./No. | €/Stück Pce./Pce./Pza. |
|----------------------------------|--|---------|-------------------|---------------------------|
| | 206 x 10 x 4,5 sinus | 0,013 | 2106.0110.402 | 0,60 |

CASAGRANDE

| Maschinen-Type Type/Type/Tipo | Abmessungen in mm Size/Dimension/Tamaño | △ kg | FASSCO Nr./No. | €/Stück Pce./Pce./Pza. |
|----------------------------------|--|---------|-------------------|---------------------------|
| | 358 x 14 x 14 | 0,098 | 2026.9014.002 | 2,60 |
| | 498 x 14 x 14 | 0,137 | 2026.9014.012 | 3,60 |
| | 1200 x 14 x 14 | 0,329 | 2026.9014.022 | 8,65 |

COMECA/F.T.P.

| Maschinen-Type Type/Type/Tipo | Abmessungen in mm Size/Dimension/Tamaño | △ kg | FASSCO Nr./No. | €/Stück Pce./Pce./Pza. |
|----------------------------------|--|---------|-------------------|---------------------------|
| 82 | 820 x 16 x 5 | 0,092 | 2045.0116.502 | 3,75 |
| 82 | 820 x 20 x 4 | 0,100 | 2045.0120.402 | 3,80 |
| 107 | 1070 x 16 x 5 | 0,120 | 2045.0216.502 | 4,90 |
| 112 | 1120 x 16 x 5 | 0,125 | 2045.0316.502 | 5,10 |
| 115 | 1150 x 16 x 5 | 0,129 | 2045.0416.502 | 5,25 |

COMO

| Maschinen-Type Type/Type/Tipo | Abmessungen in mm Size/Dimension/Tamaño | △ ⁺ △ kg | FASSCO Nr./No. | €/Stück Pce./Pce./Pza. |
|----------------------------------|--|------------------------|-------------------|---------------------------|
| 82 | 820 x 20 x 20 | 0,459 | 2031.0320.002 | 11,60 |
| 92 | 930 x 14 x 3 | 0,055 | 2031.0214.302 | 2,85 |
| 110 | 1145 x 14 x 3 | 0,067 | 2031.0414.302 | 3,55 |
| 110 | 1150 x 15 x 4 | 0,097 | 2031.0415.402 | 4,50 |
| 116 | 1200 x 12 x 3 | 0,060 | 2031.0512.302 | 2,95 |
| 116 | 1200 x 14 x 3 | 0,071 | 2031.0514.302 | 3,70 |
| 116 | 1200 x 19 x 19 | 0,606 | 2031.0519.002 | 12,75 |
| 170 | 1705 x 14 x 5 | 0,167 | 2031.0714.502 | 7,75 |

CORTA (RAPIER)

| Maschinen-Type Type/Type/Tipo | Abmessungen in mm Size/Dimension/Tamaño | △ ⁺ △ kg | FASSCO Nr./No. | €/Stück Pce./Pce./Pza. |
|----------------------------------|--|------------------------|-------------------|---------------------------|
| 58 | 620 x 15 x 5 | 0,065 | 2029.0115.502 | 2,85 |
| 72 | 760 x 15 x 5 | 0,080 | 2029.0215.502 | 3,50 |
| 72 neu | 730 x 10 x 4,5 sinus | 0,046 | 2029.0410.402 | 1,95 |
| 76 | 770 x 10 x 4,5 sinus | 0,049 | 2029.0410.412 | 2,00 |
| 78 | 820 x 10 x 4,5 sinus | 0,052 | 2029.0810.412 | 2,20 |

DAHLE

| Maschinen-Type Type/Type/Tipo | Abmessungen in mm Size/Dimension/Tamaño | △ ⁺ △ kg | FASSCO Nr./No. | €/Stück Pce./Pce./Pza. |
|----------------------------------|--|------------------------|-------------------|---------------------------|
| | 395 x 13,8 x 13,8 | 0,105 | 2038.0013.012 | 3,20 |
| | 438 x 13,8 x 13,8 | 0,117 | 2038.0013.022 | 3,55 |
| | 467 x 13,8 x 13,8 | 0,125 | 2038.0013.032 | 3,75 |
| | 483 x 13,8 x 13,8 | 0,129 | 2038.0013.042 | 3,85 |

DÖRRIES-PRINTAX

| Maschinen-Type Type/Type/Tipo | Abmessungen in mm Size/Dimension/Tamaño | △ ⁺ △ kg | FASSCO Nr./No. | €/Stück Pce./Pce./Pza. |
|----------------------------------|--|------------------------|-------------------|---------------------------|
| 78 | 784 x 15 x 4 | 0,066 | 2008.0115.402 | 3,10 |
| 80 | 804 x 15 x 4 | 0,068 | 2008.0615.402 | 3,15 |
| 82 | 824 x 15 x 4 | 0,069 | 2008.0715.402 | 3,20 |
| 86 | 874 x 15 x 4 | 0,073 | 2008.0215.402 | 3,40 |
| 87/92 | 924 x 15 x 4 | 0,078 | 2008.0815.402 | 3,60 |
| 107 | 1074 x 15 x 4 | 0,090 | 2008.0315.402 | 4,15 |
| 115 | 1152 x 15 x 4 | 0,097 | 2008.0915.402 | 4,50 |
| 138 | 1384 x 15 x 4 | 0,116 | 2008.0415.402 | 5,40 |
| 145 | 1452 x 15 x 4 | 0,122 | 2008.1015.402 | 5,65 |

EBA (EHINGER)

| Maschinen-Type Type/Type/Tipo | Abmessungen in mm Size/Dimension/Tamaño | △ kg | FASSCO Nr./No. | €/Stück Pce./Pce./Pza. |
|----------------------------------|--|---------|-------------------|---------------------------|
| 360 | 386 x 14 x 14 | 0,106 | 2037.0114.002 | 2,80 |
| 480 | 520 x 14 x 14 | 0,143 | 2037.0514.002 | 3,80 |
| 550 | 560 x 14 x 14 | 0,154 | 2037.0414.002 | 4,05 |
| 720 | 730 x 14 x 14 | 0,200 | 2037.0314.002 | 5,25 |

EUROCUTTER

| Maschinen-Type Type/Type/Tipo | Abmessungen in mm Size/Dimension/Tamaño | △ kg | FASSCO Nr./No. | €/Stück Pce./Pce./Pza. |
|----------------------------------|--|---------|-------------------|---------------------------|
| 78 | 780 x 19 x 19 | 0,394 | 2105.0519.002 | 8,30 |
| 116 | 1160 x 10 x 10 | 0,162 | 2105.0310.002 | 6,00 |

F.L.

| Maschinen-Type Type/Type/Tipo | Abmessungen in mm Size/Dimension/Tamaño | △ kg | FASSCO Nr./No. | €/Stück Pce./Pce./Pza. |
|----------------------------------|--|---------|-------------------|---------------------------|
| 36 | 400 x 10 x 10 | 0,056 | 2030.0010.012 | 2,10 |
| 54 | 570 x 10 x 10 | 0,080 | 2030.0010.022 | 3,95 |
| 58 | 590 x 10 x 4 sinus | 0,033 | 2030.1610.402 | 1,50 |
| 67 | 670 x 15 x 15 | 0,211 | 2030.0015.002 | 5,40 |
| 72 | 720 x 18 x 18 | 0,327 | 2030.1418.002 | 7,65 |
| 76 | 767 x 10 x 4 sinus | 0,043 | 2030.1210.402 | 2,00 |
| 82 | 820 x 10 x 4 sinus | 0,046 | 2030.0110.402 | 2,20 |
| 82 | 820 x 20 x 20 | 0,459 | 2030.0120.002 | 11,60 |
| 92 | 920 x 10 x 4 sinus | 0,052 | 2030.1310.402 | 2,40 |
| 92 | 920 x 10 x 10 | 0,129 | 2030.0210.002 | 4,75 |
| 106 | 1060 x 10 x 4 sinus | 0,059 | 2030.0310.402 | 2,80 |
| 106 | 1060 x 20 x 20 | 0,594 | 2030.0320.002 | 15,00 |
| 115 | 1200 x 10 x 4 sinus | 0,067 | 2030.1510.402 | 3,20 |
| 115 | 1150 x 10 x 10 | 0,161 | 2030.0410.002 | 5,95 |
| 115 | 1200 x 15 x 15 | 0,378 | 2030.1515.002 | 9,75 |
| 125 | 1250 x 20 x 20 | 0,700 | 2030.0520.002 | 17,65 |
| 135 | 1350 x 10 x 4 sinus | 0,076 | 2030.0610.402 | 3,55 |
| 135 | 1350 x 20 x 20 | 0,756 | 2030.0620.002 | 19,05 |
| 150 | 1500 x 10 x 10 | 0,210 | 2030.0710.002 | 7,75 |
| 150 | 1500 x 20 x 20 | 0,840 | 2030.0720.002 | 21,20 |
| 165 | 1650 x 10 x 10 | 0,231 | 2030.0810.002 | 8,60 |
| 165 | 1650 x 20 x 20 | 0,924 | 2030.0820.002 | 23,30 |
| 200 | 2005 x 10 x 10 | 0,281 | 2030.1010.002 | 10,40 |
| 200 | 2005 x 20 x 20 | 1,123 | 2030.1020.002 | 28,35 |
| 220 | 2205 x 10 x 10 | 0,309 | 2030.1110.002 | 11,40 |
| 220 | 2205 x 20 x 20 | 1,235 | 2030.1120.002 | 31,15 |

HEROLD

| Maschinen-Type Type/Type/Tipo | Abmessungen in mm Size/Dimension/Tamaño | △ ⁺ _△ kg | FASSCO Nr./No. | €/Stück Pce./Pce./Pza. |
|----------------------------------|--|-----------------------------------|-------------------|---------------------------|
| 46 | 470 x 18 x 5 | 0,059 | 2002.0118.502 | 2,20 |
| 51 | 520 x 18 x 5 | 0,066 | 2002.1518.502 | 2,35 |
| 52 | 530 x 18 x 5 | 0,067 | 2002.1118.502 | 2,40 |
| 65 | 660 x 18 x 5 | 0,083 | 2002.1018.502 | 2,95 |
| 72 | 730 x 18 x 5 | 0,092 | 2002.1218.502 | 3,30 |
| 76 | 770 x 18 x 5 | 0,097 | 2002.0318.502 | 3,55 |
| 83 | 840 x 18 x 5 | 0,106 | 2002.0518.502 | 3,80 |
| 88 | 890 x 18 x 5 | 0,112 | 2002.0618.502 | 4,05 |
| 92 | 930 x 18 x 5 | 0,117 | 2002.1318.502 | 4,20 |
| 107 | 1080 x 18 x 5 | 0,136 | 2002.1618.502 | 4,95 |
| 110 | 1110 x 18 x 5 | 0,140 | 2002.0918.502 | 5,05 |
| 115 | 1160 x 18 x 5 | 0,146 | 2002.1418.502 | 5,25 |

HÖRAUF

| Maschinen-Type Type/Type/Tipo | Abmessungen in mm Size/Dimension/Tamaño | △ ⁺ _△ kg | FASSCO Nr./No. | €/Stück Pce./Pce./Pza. |
|----------------------------------|--|-----------------------------------|-------------------|---------------------------|
| | 280 x 13 x 4 | 0,020 | 2021.0013.402 | 1,00 |
| | 320 x 13 x 4 | 0,023 | 2021.0013.412 | 1,10 |
| | 325 x 30 x 4 | 0,055 | 2021.0030.402 | 2,60 |
| | 1000 x 13 x 4 | 0,073 | 2021.0013.422 | 3,55 |
| | 1100 x 13 x 3 | 0,060 | 2021.0013.302 | 3,40 |
| | 1100 x 13 x 4 | 0,080 | 2021.0013.432 | 3,85 |

HORIZON

| Maschinen-Type Type/Type/Tipo | Abmessungen in mm Size/Dimension/Tamaño | △ ⁺ _△ kg | FASSCO Nr./No. | €/Stück Pce./Pce./Pza. |
|----------------------------------|--|-----------------------------------|-------------------|---------------------------|
| 58 | 615 x 12 x 12 | 0,124 | 2078.0212.002 | 3,60 |
| 61 | 620 x 12 x 12 | 0,125 | 2078.0312.002 | 3,70 |
| 64 | 660 x 12 x 12 | 0,133 | 2078.0112.002 | 3,90 |

HUNKELER (CASAGRANDE)

| Maschinen-Type Type/Type/Tipo | Abmessungen in mm Size/Dimension/Tamaño | △ ⁺ _△ kg | FASSCO Nr./No. | €/Stück Pce./Pce./Pza. |
|----------------------------------|--|-----------------------------------|-------------------|---------------------------|
| | 358 x 14 x 14 | 0,098 | 2026.9014.002 | 2,60 |
| | 498 x 14 x 14 | 0,137 | 2026.9014.012 | 3,60 |
| | 1200 x 14 x 14 | 0,329 | 2026.9014.022 | 8,65 |

ITOH

| Maschinen-Type Type/Type/Tipo | Abmessungen in mm Size/Dimension/Tamaño | △ kg | FASSCO Nr./No. | €/Stück Pce./Pce./Pza. |
|----------------------------------|--|---------|-------------------|---------------------------|
| | 1041 x 16 x 16 | 0,373 | 2069.0216.002 | 9,50 |
| | 1193 x 16 x 16 | 0,427 | 2069.0916.002 | 10,90 |
| | 1395 x 16 x 16 | 0,500 | 2069.1116.002 | 12,75 |
| | 1618 x 16 x 16 | 0,579 | 2069.1016.002 | 14,80 |

JUD

| Maschinen-Type Type/Type/Tipo | Abmessungen in mm Size/Dimension/Tamaño | △ kg | FASSCO Nr./No. | €/Stück Pce./Pce./Pza. |
|----------------------------------|--|---------|-------------------|---------------------------|
| 40 | 420 x 10 x 10 | 0,059 | 2044.0010.002 | 2,25 |
| 50 | 530 x 10 x 10 | 0,074 | 2044.0210.002 | 2,80 |
| 60 | 620 x 10 x 10 | 0,087 | 2044.0610.002 | 3,25 |
| 67 | 700 x 10 x 10 | 0,098 | 2044.0510.002 | 3,70 |
| 70 | 720 x 10 x 10 | 0,101 | 2044.0110.002 | 3,75 |
| 82 | 820 x 10 x 10 | 0,115 | 2044.0710.002 | 4,30 |
| 84 | 851 x 10 x 10 | 0,119 | 2044.0310.002 | 4,45 |
| 106 | 1065 x 10 x 10 | 0,149 | 2044.0810.002 | 5,55 |
| 108 | 1085 x 10 x 10 | 0,152 | 2044.0410.002 | 5,60 |
| 112 | 1130 x 10 x 10 | 0,158 | 2044.0010.012 | 5,90 |

KOLBUS

| Maschinen-Type Type/Type/Tipo | Abmessungen in mm Size/Dimension/Tamaño | △ kg | FASSCO Nr./No. | €/Stück Pce./Pce./Pza. |
|----------------------------------|--|---------|-------------------|---------------------------|
| Dreischneider | 291 x 20 x 4 | 0,033 | 2062.0020.402 | 1,35 |
| Dreischneider | 1050 x 20 x 4 | 0,118 | 2062.0020.412 | 4,75 |
| Dreischneider | 1050 x 20 x 20 aK | 0,588 | 2062.0020.002 | 14,85 |

KRAUSE-BIAGOSCH

| Maschinen-Type Type/Type/Tipo | Abmessungen in mm Size/Dimension/Tamaño | △ kg | FASSCO Nr./No. | €/Stück Pce./Pce./Pza. |
|----------------------------------|--|---------|-------------------|---------------------------|
| 36 | 365 x 10 x 10 | 0,051 | 2003.0810.002 | 1,90 |
| 52 | 525 x 10 x 3 | 0,022 | 2003.0110.302 | 1,35 |
| 68 | 685 x 11 x 3 | 0,032 | 2003.0211.302 | 1,75 |
| 72 B | 723 x 11 x 3 | 0,033 | 2003.0311.302 | 1,80 |
| 72 OH | 723 x 12 x 12 | 0,146 | 2003.0912.002 | 4,20 |
| 76 | 790 x 18 x 4 | 0,080 | 2003.0518.402 | 2,65 |
| 78 | 790 x 18 x 4 | 0,080 | 2003.0518.402 | 2,65 |
| 80/82 | 824 x 18 x 4 | 0,083 | 2003.0718.402 | 2,80 |
| 86/88 | 884 x 18 x 4 | 0,089 | 2003.1018.402 | 2,95 |
| 106/107 | 1080 x 18 x 4 | 0,109 | 2003.1418.402 | 3,60 |

KRUG & PRIESTER/IDEAL

| Maschinen-Type Type/Type/Tipo | Abmessungen in mm Size/Dimension/Tamaño | △ kg | FASSCO Nr./No. | €/Stück Pce./Pce./Pza. |
|----------------------------------|--|---------|-------------------|---------------------------|
| 36 | 370 x 14 x 14 | 0,102 | 2015.0114.002 | 2,65 |
| 38 | 390 x 14 x 14 | 0,107 | 2015.0514.002 | 2,85 |
| 3915 | 453 x 14 x 14 | 0,124 | 2015.1214.002 | 3,25 |
| 4205/4215 | 570 x 14 x 14 gerillt | 0,155 | 2015.1514.002 | 5,80 |
| 4305/4315 | 570 x 14 x 14 gerillt | 0,155 | 2015.1314.002 | 5,80 |
| 45 | 470 x 14 x 14 | 0,129 | 2015.0214.002 | 3,40 |
| 4705 | 668 x 14 x 14 gerillt | 0,184 | 2015.0714.012 | 6,60 |
| 48 | 572 x 14 x 14 KL | 0,157 | 2015.0714.002 | 5,05 |
| 525 | 645 x 14 x 14 KL | 0,177 | 2015.0414.002 | 5,65 |
| 5220/5221 | 700 x 14 x 14 KL | 0,192 | 2015.1114.002 | 6,25 |
| 52 | 700 x 19 x 6 KL,aK | 0,112 | 2015.0319.602 | 5,25 |
| 65/650 | 765 x 14 x 14 KL | 0,210 | 2015.0814.002 | 6,80 |
| 72 | 885 x 14 x 14 KL | 0,243 | 2015.0914.002 | 7,80 |

LAWSON

| Maschinen-Type Type/Type/Tipo | Abmessungen in mm Size/Dimension/Tamaño | △ kg | FASSCO Nr./No. | €/Stück Pce./Pce./Pza. |
|----------------------------------|--|---------|-------------------|---------------------------|
| p. Meter | 1000 x 19,05 x 19,05 | 0,508 | 2048.0019.002 | 10,65 |

LHERMITE

| Maschinen-Type Type/Type/Tipo | Abmessungen in mm Size/Dimension/Tamaño | △ kg | FASSCO Nr./No. | €/Stück Pce./Pce./Pza. |
|----------------------------------|--|---------|-------------------|---------------------------|
| 82 | 820 x 15 x 15 | 0,258 | 2046.0715.002 | 6,60 |
| 105/106 | 1065 x 20 x 20 | 0,596 | 2046.0220.002 | 15,10 |
| 114 | 1145 x 20 x 20 | 0,641 | 2046.0320.002 | 16,15 |
| 132 | 1325 x 20 x 20 | 0,742 | 2046.0420.002 | 18,75 |
| 165 | 1660 x 20 x 20 | 0,930 | 2046.0520.002 | 23,40 |

MANDELLI

| Maschinen-Type Type/Type/Tipo | Abmessungen in mm Size/Dimension/Tamaño | △ ⁺ △ kg | FASSCO Nr./No. | €/Stück Pce./Pce./Pza. |
|----------------------------------|--|------------------------|-------------------|---------------------------|
| 58 | 590 x 16 x 16 | 0,211 | 2019.0116.002 | 5,35 |
| 62 | 630 x 16 x 16 | 0,226 | 2019.0216.002 | 5,70 |
| 72 | 720 x 16 x 16 | 0,258 | 2019.0316.002 | 6,55 |
| 76 | 760 x 16 x 16 | 0,272 | 2019.0316.012 | 6,90 |
| 82 | 820 x 16 x 16 | 0,294 | 2019.0416.002 | 7,45 |
| 92 | 920 x 16 x 16 | 0,330 | 2019.0816.002 | 8,35 |
| 105 | 1060 x 16 x 16 | 0,380 | 2019.0516.002 | 9,60 |
| 115 | 1160 x 16 x 16 | 0,416 | 2019.0916.002 | 10,50 |
| 132 | 1330 x 16 x 16 | 0,477 | 2019.0716.002 | 12,10 |
| 150 | 1510 x 16 x 16 | 0,541 | 2019.0616.002 | 13,70 |
| 155 | 1560 x 16 x 16 | 0,559 | 2019.0616.012 | 14,20 |

MÜLLER-MARTINI

| Maschinen-Type Type/Type/Tipo | Abmessungen in mm Size/Dimension/Tamaño | △ ⁺ △ kg | FASSCO Nr./No. | €/Stück Pce./Pce./Pza. |
|----------------------------------|--|------------------------|-------------------|---------------------------|
| 3670 | 308 x 10 x 10 | 0,043 | 2014.5710.002 | 1,60 |
| 3670 | 318 x 20 x 10 | 0,178 | 2014.5720.102 | 2,40 |
| 3670 | 1000 x 10 x 10 | 0,140 | 2014.5710.012 | 5,20 |
| 3670 | 1000 x 20 x 10 | 0,560 | 2014.5720.112 | 7,50 |

OMAC

| Maschinen-Type Type/Type/Tipo | Abmessungen in mm Size/Dimension/Tamaño | △ ⁺ △ kg | FASSCO Nr./No. | €/Stück Pce./Pce./Pza. |
|----------------------------------|--|------------------------|-------------------|---------------------------|
| | 776 x 9,3 x 5 | 0,051 | 2020.0109.502 | 3,15 |
| | 776 x 9,7 x 5 | 0,053 | 2020.0109.512 | 3,15 |
| 84 | 850 x 9,3 x 5 | 0,055 | 2020.0709.502 | 3,50 |
| 84 | 850 x 9,7 x 5 | 0,058 | 2020.0709.512 | 3,50 |
| 106/107 | 1080 x 9,3 x 5 | 0,070 | 2020.0609.502 | 4,35 |
| 106/107 | 1080 x 9,7 x 5 | 0,073 | 2020.0609.512 | 4,35 |
| 112 | 1120 x 9,5 x 5 | 0,074 | 2020.0809.502 | 4,60 |
| 112 | 1120 x 9,7 x 5 | 0,076 | 2020.0809.512 | 4,60 |
| 131 | 1310 x 15 x 15 | 0,413 | 2020.1215.002 | 10,60 |
| 148 | 1505 x 9,5 x 5 | 0,100 | 2020.1509.502 | 6,10 |
| 148 | 1505 x 9,7 x 5 | 0,102 | 2020.1509.512 | 6,10 |
| 260 | 2610 x 15 x 15 | 0,822 | 2020.2115.002 | 21,15 |
| 300 | 3000 x 15 x 15 | 0,945 | 2020.2215.002 | 24,30 |

| Maschinen-Type Type/Type/Tipo | Abmessungen in mm Size/Dimension/Tamaño | △ kg | FASSCO Nr./No. | €/Stück Pce./Pce./Pza. |
|----------------------------------|--|---------|-------------------|---------------------------|
| 76 | 770 x 10 x 4,5 sinus | 0,049 | 2005.2210.402 | 2,00 |
| 83 | 835 x 14 x 3 | 0,049 | 2005.0414.302 | 2,60 |
| 83 | 835 x 10 x 10 | 0,117 | 2005.0410.002 | 4,35 |
| 83 | 835 x 16 x 16 | 0,299 | 2005.0416.002 | 7,65 |
| 83 | 835 x 19 x 19 | 0,422 | 2005.0419.002 | 8,85 |
| 87 | 875 x 14 x 3 | 0,051 | 2005.0714.302 | 2,70 |
| 87 | 875 x 10 x 10 | 0,123 | 2005.0710.002 | 4,60 |
| 87 | 875 x 16 x 16 | 0,314 | 2005.0716.002 | 7,95 |
| 87 | 875 x 19 x 19 | 0,442 | 2005.0719.002 | 9,25 |
| 92 | 925 x 14 x 3 | 0,054 | 2005.1914.302 | 2,85 |
| 92 | 930 x 10 x 4,5 sinus | 0,059 | 2005.1910.402 | 2,40 |
| 92 | 925 x 10 x 10 | 0,130 | 2005.1910.002 | 4,75 |
| 92 | 925 x 16 x 16 | 0,332 | 2005.1916.002 | 8,35 |
| 92 | 925 x 19 x 19 | 0,467 | 2005.1919.002 | 9,80 |
| 106 | 1065 x 14 x 3 | 0,063 | 2005.0614.302 | 3,25 |
| 106 | 1065 x 10 x 10 | 0,149 | 2005.0610.002 | 5,55 |
| 106 | 1065 x 16 x 16 | 0,382 | 2005.0616.002 | 9,70 |
| 106 | 1065 x 19 x 19 | 0,538 | 2005.0619.002 | 11,25 |
| 107 | 1075 x 14 x 3 | 0,063 | 2005.1114.302 | 3,25 |
| 107 | 1075 x 10 x 10 | 0,151 | 2005.1110.002 | 5,60 |
| 107 | 1075 x 16 x 16 | 0,385 | 2005.1116.002 | 9,75 |
| 107 | 1075 x 19 x 19 | 0,543 | 2005.1119.002 | 11,40 |
| 115 | 1155 x 14 x 3 | 0,068 | 2005.1614.302 | 3,55 |
| 115 | 1160 x 10 x 4,5 sinus | 0,073 | 2005.1610.402 | 3,10 |
| 115 | 1155 x 10 x 10 | 0,162 | 2005.1610.002 | 6,00 |
| 115 | 1155 x 16 x 16 | 0,414 | 2005.1616.002 | 10,50 |
| 115 | 1155 x 19 x 19 | 0,584 | 2005.1619.002 | 12,25 |
| 132 | 1325 x 14 x 3 | 0,078 | 2005.1214.302 | 4,05 |
| 132 | 1330 x 10 x 4,5 sinus | 0,084 | 2005.1210.402 | 3,50 |
| 132 | 1325 x 10 x 10 | 0,186 | 2005.1210.002 | 6,85 |
| 132 | 1325 x 16 x 16 | 0,475 | 2005.1216.002 | 12,00 |
| 132 | 1325 x 19 x 19 | 0,670 | 2005.1219.002 | 14,00 |
| 167 | 1675 x 14 x 3 | 0,098 | 2005.1314.312 | 5,10 |
| 167 | 1675 x 16 x 16 | 0,600 | 2005.1316.012 | 15,20 |
| 168 | 1685 x 10 x 4,5 sinus | 0,106 | 2005.1310.402 | 4,50 |
| 168 | 1685 x 14 x 3 | 0,099 | 2005.1314.302 | 5,10 |
| 168 | 1685 x 16 x 16 | 0,604 | 2005.1316.002 | 15,25 |
| 220 | 2260 x 14 x 3 | 0,133 | 2005.1414.302 | 6,90 |
| 220 | 2260 x 10 x 10 | 0,316 | 2005.1410.002 | 11,80 |
| 220 | 2260 x 16 x 16 | 0,810 | 2005.1416.002 | 20,55 |
| 220/225 | 2260 x 10 x 4,5 sinus | 0,142 | 2005.1410.402 | 5,95 |
| Dreischneider | 1000 x 15 x 5 | 0,105 | 2005.9015.502 | 4,60 |
| Dreischneider | 1100 x 15 x 5 | 0,116 | 2005.9015.512 | 5,00 |
| Dreischneider | 1075 x 12 x 4 | 0,072 | 2005.9512.402 | 3,80 |
| SDY | 1000 x 16 x 16 | 0,358 | 2005.9716.002 | 9,10 |

PIVANO

| Maschinen-Type Type/Type/Tipo | Abmessungen in mm Size/Dimension/Tamaño | \triangle kg | FASSCO Nr./No. | €/Stück Pce./Pce./Pza. |
|----------------------------------|--|-------------------|-------------------|---------------------------|
| 52 | 530 x 20 x 20 | 0,297 | 2006.0120.002 | 7,50 |
| 60 | 600 x 20 x 20 | 0,336 | 2006.1720.002 | 8,50 |
| 70 | 700 x 20 x 20 | 0,392 | 2006.0220.002 | 9,85 |
| 76 | 770 x 20 x 20 | 0,431 | 2006.1620.002 | 10,90 |
| 82 | 820 x 20 x 20 | 0,459 | 2006.0320.002 | 11,60 |
| 82 | 830 x 10 x 5 | 0,058 | 2006.0310.502 | 3,40 |
| 103 | 1030 x 10 x 10 | 0,144 | 2006.1310.002 | 5,35 |
| 106 | 1060 x 20 x 20 | 0,594 | 2006.0620.002 | 15,00 |
| 107 | 1075 x 19 x 19 | 0,543 | 2006.0719.002 | 11,40 |
| 112 | 1130 x 10 x 5 | 0,079 | 2006.1210.502 | 4,60 |
| 130 | 1320 x 10 x 5 | 0,092 | 2006.0910.502 | 5,35 |
| 135 | 1360 x 10 x 5 | 0,095 | 2006.1010.502 | 5,55 |
| 170 | 1710 x 10 x 5 | 0,120 | 2006.1110.502 | 6,90 |
| Dreischneider | 1200 x 12 x 4 | 0,081 | 2006.9012.402 | 4,30 |

POLAR

| Maschinen-Type Type/Type/Tipo | Abmessungen in mm Size/Dimension/Tamaño | \triangle kg | FASSCO Nr./No. | €/Stück Pce./Pce./Pza. |
|----------------------------------|--|-------------------|-------------------|---------------------------|
| 55 | 560 x 10 x 4,5 sinus | 0,035 | 2007.2910.402 | 1,45 |
| 58 | 590 x 10 x 4,5 sinus | 0,037 | 2007.3010.402 | 1,50 |
| 66 | 670 x 10 x 4,5 sinus | 0,042 | 2007.4610.402 | 1,80 |
| 72 | 730 x 10 x 4,5 sinus | 0,046 | 2007.0910.402 | 1,95 |
| 71 | 720 x 10 x 4,5 sinus | 0,045 | 2007.0910.412 | 1,90 |
| 76 | 770 x 10 x 4,5 sinus | 0,049 | 2007.2810.402 | 2,00 |
| 78 | 790 x 10 x 4,5 sinus | 0,050 | 2007.3910.402 | 2,10 |
| 78/80 | 810 x 10 x 4,5 sinus | 0,051 | 2007.0110.402 | 2,20 |
| 82 | 830 x 10 x 4,5 sinus | 0,052 | 2007.0310.402 | 2,25 |
| 86 | 870 x 10 x 4,5 sinus | 0,055 | 2007.0510.402 | 2,30 |
| 90 | 910 x 10 x 4,5 sinus | 0,057 | 2007.0610.402 | 2,35 |
| 92 | 930 x 10 x 4,5 sinus | 0,059 | 2007.2610.402 | 2,40 |
| 105 | 1060 x 10 x 4,5 sinus | 0,067 | 2007.0710.402 | 2,80 |
| 107 | 1080 x 10 x 4,5 sinus | 0,068 | 2007.0810.402 | 2,85 |
| 112 | 1130 x 10 x 4,5 sinus | 0,071 | 2007.0810.412 | 2,95 |
| 115 | 1160 x 10 x 4,5 sinus | 0,073 | 2007.2410.402 | 3,10 |
| 132 | 1330 x 10 x 4,5 sinus | 0,084 | 2007.1110.402 | 3,50 |
| 137 | 1380 x 10 x 4,5 sinus | 0,087 | 2007.1310.402 | 3,60 |
| 145 | 1460 x 10 x 4,5 sinus | 0,092 | 2007.2010.402 | 3,80 |
| 150 | 1510 x 10 x 4,5 sinus | 0,095 | 2007.1410.402 | 4,00 |
| 155 | 1560 x 10 x 4,5 sinus | 0,098 | 2007.2510.402 | 4,10 |
| 176 | 1770 x 10 x 4,5 sinus | 0,112 | 2007.3510.402 | 4,65 |

PRESTO

| Maschinen-Type Type/Type/Tipo | Abmessungen in mm Size/Dimension/Tamaño | △ kg | FASSCO Nr./No. | €/Stück Pce./Pce./Pza. |
|----------------------------------|--|---------|-------------------|---------------------------|
| 82 | 820 x 18 x 18 | 0,372 | 2060.0118.002 | 8,70 |

R.P.M.

| Maschinen-Type Type/Type/Tipo | Abmessungen in mm Size/Dimension/Tamaño | △ kg | FASSCO Nr./No. | €/Stück Pce./Pce./Pza. |
|----------------------------------|--|---------|-------------------|---------------------------|
| 82 | 821 x 18 x 4 | 0,083 | 2009.1018.402 | 2,80 |
| 105/107 | 1070 x 18 x 4 | 0,108 | 2009.0218.402 | 3,60 |
| 115 | 1154 x 18 x 4 | 0,116 | 2009.0418.402 | 3,85 |
| 130 | 1304 x 18 x 4 | 0,131 | 2009.0518.402 | 4,35 |
| 132 | 1320 x 18 x 4 | 0,133 | 2009.0618.402 | 4,45 |
| 153 | 1530 x 18 x 4 | 0,154 | 2009.0718.402 | 5,10 |
| 165 | 1650 x 18 x 4 | 0,166 | 2009.0818.402 | 5,55 |

SAROGLIA

| Maschinen-Type Type/Type/Tipo | Abmessungen in mm Size/Dimension/Tamaño | △ kg | FASSCO Nr./No. | €/Stück Pce./Pce./Pza. |
|----------------------------------|--|---------|-------------------|---------------------------|
| 72 | 720 x 10 x 10 | 0,101 | 2033.0110.002 | 3,75 |
| 106 | 1060 x 10 x 10 | 0,148 | 2033.0410.002 | 5,55 |

SCHIMANEK

| Maschinen-Type Type/Type/Tipo | Abmessungen in mm Size/Dimension/Tamaño | △ kg | FASSCO Nr./No. | €/Stück Pce./Pce./Pza. |
|----------------------------------|--|---------|-------------------|---------------------------|
| 46 | 480 x 16 x 5 | 0,054 | 2025.0116.502 | 2,25 |
| 64 | 660 x 16 x 5 | 0,074 | 2025.0216.502 | 2,95 |
| 72 | 730 x 16 x 5 | 0,082 | 2025.1016.502 | 3,30 |
| 81 | 830 x 16 x 5 | 0,093 | 2025.0516.502 | 3,80 |
| 86 | 880 x 16 x 5 | 0,099 | 2025.0616.502 | 4,05 |
| 90 | 922 x 16 x 5 | 0,103 | 2025.0716.502 | 4,20 |
| 106 | 1080 x 16 x 5 | 0,121 | 2025.0816.502 | 4,95 |
| 112 | 1130 x 16 x 5 | 0,127 | 2025.1316.502 | 5,10 |
| 120 | 1282 x 16 x 5 | 0,144 | 2025.0016.502 | 5,85 |

SCHNEIDER

| Maschinen-Type Type/Type/Tipo | Abmessungen in mm Size/Dimension/Tamaño | △ ⁺ △ kg | FASSCO Nr./No. | €/Stück Pce./Pce./Pza. |
|----------------------------------|--|------------------------|-------------------|---------------------------|
| 76 | 769 x 10 x 4,5 sinus | 0,048 | 2010.1410.402 | 2,00 |
| 78 | 789 x 10 x 4,5 sinus | 0,050 | 2010.0210.402 | 2,10 |
| 78 | 781 x 12 x 3 | 0,039 | 2010.0212.302 | 1,95 |
| 78 | 781 x 14 x 14 | 0,214 | 2010.0214.002 | 5,60 |
| 82 | 821 x 12 x 3 | 0,041 | 2010.0312.302 | 2,10 |
| 82 | 821 x 14 x 14 | 0,225 | 2010.0314.002 | 5,90 |
| 92 | 929 x 10 x 4,5 sinus | 0,059 | 2010.1010.402 | 2,40 |
| 92 | 921 x 12 x 3 | 0,046 | 2010.1012.302 | 2,30 |
| 92 | 921 x 14 x 14 | 0,253 | 2010.1014.002 | 6,60 |
| 106 | 1061 x 12 x 3 | 0,053 | 2010.0412.302 | 2,65 |
| 106 | 1061 x 14 x 14 | 0,291 | 2010.0414.002 | 7,65 |
| 110/112 | 1106 x 12 x 3 | 0,056 | 2010.0412.312 | 2,80 |
| 110/112 | 1106 x 14 x 14 | 0,303 | 2010.0414.012 | 7,95 |
| 115 | 1159 x 10 x 4,5 sinus | 0,073 | 2010.1310.402 | 3,10 |
| 115 | 1151 x 12 x 3 | 0,058 | 2010.1312.302 | 2,90 |
| 115 | 1151 x 14 x 14 | 0,316 | 2010.1314.002 | 8,30 |
| 132 | 1329 x 10 x 4,5 sinus | 0,084 | 2010.0510.402 | 3,50 |
| 132 | 1321 x 12 x 3 | 0,067 | 2010.0512.302 | 3,30 |
| 132 | 1321 x 14 x 14 | 0,362 | 2010.0514.002 | 9,55 |
| 137 | 1379 x 10 x 4,5 sinus | 0,087 | 2010.1610.402 | 3,60 |
| 155 | 1559 x 10 x 4,5 sinus | 0,098 | 2010.0610.402 | 4,10 |
| 155 | 1551 x 12 x 3 | 0,078 | 2010.0612.302 | 3,85 |
| 155 | 1551 x 14 x 14 | 0,426 | 2010.0614.002 | 11,20 |
| 185 | 1859 x 10 x 4,5 sinus | 0,117 | 2010.0710.402 | 4,95 |
| 185 | 1851 x 12 x 3 | 0,093 | 2010.0712.302 | 4,65 |
| 185 | 1851 x 14 x 14 | 0,508 | 2010.0714.002 | 13,35 |
| 260 | 2601 x 12 x 3 | 0,131 | 2010.1212.302 | 6,50 |
| 260 | 2601 x 14 x 14 | 0,714 | 2010.1214.002 | 18,75 |

SEYBOLD

| Maschinen-Type Type/Type/Tipo | Abmessungen in mm Size/Dimension/Tamaño | △ ⁺ △ kg | FASSCO Nr./No. | €/Stück Pce./Pce./Pza. |
|----------------------------------|--|------------------------|-------------------|---------------------------|
| p. Meter | 1000 x 19,05 x 19,05 | 0,508 | 2052.0019.002 | 10,65 |

SPERR & LECHNER

| Maschinen-Type Type/Type/Tipo | Abmessungen in mm Size/Dimension/Tamaño | △ ⁺ △ kg | FASSCO Nr./No. | €/Stück Pce./Pce./Pza. |
|----------------------------------|--|------------------------|-------------------|---------------------------|
| Hydromat | 1000 x 12 x 4 | 0,067 | 2011.9112.402 | 3,55 |
| Hydromat | 1000 x 12,5 x 12,5 | 0,219 | 2011.9112.002 | 6,10 |
| Hydromat | 1200 x 12,5 x 12,5 | 0,263 | 2011.9112.012 | 7,35 |
| Imprima | 1200 x 12 x 4 | 0,081 | 2011.9012.402 | 4,30 |

TRÄNKLEIN

| Maschinen-Type Type/Type/Tipo | Abmessungen in mm Size/Dimension/Tamaño | △ kg | FASSCO Nr./No. | €/Stück Pce./Pce./Pza. |
|----------------------------------|--|---------|-------------------|---------------------------|
| 80 | 816 x 14 x 4 | 0,064 | 2012.0414.402 | 2,90 |
| 86 | 865 x 14 x 4 | 0,068 | 2012.0514.402 | 3,10 |
| 89 | 895 x 14 x 4 | 0,070 | 2012.0614.402 | 3,20 |
| 92 | 925 x 14 x 4 | 0,073 | 2012.1114.402 | 3,25 |
| 115 | 1155 x 14 x 4 | 0,091 | 2012.0814.402 | 4,10 |

WOHLENBERG

| Maschinen-Type Type/Type/Tipo | Abmessungen in mm Size/Dimension/Tamaño | △ kg | FASSCO Nr./No. | €/Stück Pce./Pce./Pza. |
|----------------------------------|--|---------|-------------------|---------------------------|
| 76 | 765 x 10 x 4 sinus | 0,043 | 2004.2010.402 | 2,00 |
| W76P ab 2009 | 770 x 10 x 4,5 sinus | 0,049 | 2004.3210.402 | 2,00 |
| 78 | 787 x 18 x 4 | 0,079 | 2004.0118.402 | 2,65 |
| 78 | 790 x 10 x 4 sinus | 0,044 | 2004.2610.402 | 2,10 |
| 86/87 S | 878 x 18 x 4 | 0,089 | 2004.0318.402 | 2,95 |
| 86 T | 877 x 11 x 3 | 0,041 | 2004.0511.322 | 2,25 |
| 86 T | 877 x 15 x 15 | 0,276 | 2004.0515.022 | 7,10 |
| 88 T | 887 x 11 x 3 | 0,041 | 2004.0511.312 | 2,25 |
| 88 T | 887 x 15 x 15 | 0,279 | 2004.0515.012 | 7,20 |
| 90 | 909 x 11 x 3 | 0,042 | 2004.0511.302 | 2,30 |
| 90 | 909 x 15 x 15 | 0,286 | 2004.0515.002 | 7,35 |
| 92 | 930 x 10 x 4 sinus | 0,052 | 2004.2510.402 | 2,40 |
| 92 | 929 x 11 x 3 | 0,043 | 2004.1911.302 | 2,35 |
| 92 | 929 x 13 x 13 | 0,220 | 2004.1913.002 | 5,65 |
| W92P ab 2009 | 930 x 10 x 4,5 sinus | 0,059 | 2004.3310.402 | 2,40 |
| 105/106 | 1070 x 18 x 4 | 0,108 | 2004.0418.402 | 3,60 |
| 107 | 1080 x 18 x 4 | 0,109 | 2004.0718.402 | 3,70 |
| 112 | 1137 x 11 x 3 | 0,053 | 2004.0911.312 | 2,85 |
| 112 | 1137 x 15 x 15 | 0,358 | 2004.0915.012 | 9,20 |
| 115 | 1157 x 11 x 3 | 0,053 | 2004.0911.302 | 2,90 |
| 115 | 1157 x 15 x 15 | 0,364 | 2004.0915.002 | 9,40 |
| 115/115 F | 1157 x 18 x 4 | 0,117 | 2004.1818.402 | 3,85 |
| 115/115 F | 1157 x 10 x 4 sinus | 0,065 | 2004.1810.402 | 3,10 |
| 115 F | 1157 x 13 x 13 | 0,274 | 2004.1813.002 | 7,05 |
| W115P ab 2009 | 1160 x 10 x 4,5 sinus | 0,073 | 2004.3810.402 | 3,10 |
| 132 | 1330 x 18 x 4 | 0,134 | 2004.1018.402 | 4,50 |
| 132 | 1330 x 14 x 14 | 0,365 | 2004.1214.002 | 9,55 |
| W132P ab 2009 | 1330 x 10 x 4,5 sinus | 0,084 | 2004.3910.402 | 3,50 |
| 137 F | 1376 x 14 x 14 | 0,378 | 2004.2114.002 | 9,85 |
| 137 F | 1376 x 10 x 4 sinus | 0,077 | 2004.2110.402 | 3,60 |
| 146 | 1474 x 18 x 4 | 0,149 | 2004.1318.412 | 5,00 |
| 150 | 1506 x 18 x 4 | 0,152 | 2004.1318.402 | 5,05 |
| 155 | 1557 x 18 x 4 | 0,157 | 2004.1718.402 | 5,25 |
| 155 | 1557 x 10 x 4 sinus | 0,087 | 2004.1710.402 | 4,10 |

WOHLENBERG

| Maschinen-Type Type/Type/Tipo | Abmessungen in mm Size/Dimension/Tamaño | △ kg | FASSCO Nr./No. | €/Stück Pce./Pce./Pza. |
|----------------------------------|--|---------|-------------------|---------------------------|
| 165/168 | 1684 x 18 x 4 | 0,170 | 2004.1518.402 | 5,65 |
| W168P ab 2009 | 1685 x 10 x 4,5 sinus | 0,106 | 2004.3610.402 | 4,50 |
| 180 | 1807 x 18 x 4 | 0,182 | 2004.0818.402 | 6,10 |
| 185 | 1857 x 18 x 4 | 0,187 | 2004.2218.402 | 6,25 |
| 185 | 1857 x 10 x 4 sinus | 0,104 | 2004.2210.402 | 4,90 |
| 220 | 2214 x 18 x 4 | 0,223 | 2004.1618.402 | 7,45 |
| W225P ab 2009 | 2260 x 10 x 4,5 sinus | 0,142 | 2004.3710.402 | 5,95 |
| A43 | 291 x 60 x 4 | 0,098 | 2004.9060.402 | 2,60 |
| 44 F | 291 x 42 x 4 | 0,068 | 2004.9042.402 | 2,30 |
| 44 F | 291 x 41 x 4 | 0,067 | 2004.9041.402 | 2,30 |
| 44 F | 291 x 24 x 4 | 0,039 | 2004.9024.432 | 1,35 |
| 44 F | 460 x 24 x 4 | 0,062 | 2004.9024.422 | 2,10 |
| 44 F | 1000 x 24 x 4 | 0,134 | 2004.9024.402 | 4,60 |
| 44 F | 1050 x 24 x 4 | 0,141 | 2004.9024.412 | 4,75 |
| 38 F | 1150 x 11 x 3 | 0,053 | 2004.9111.302 | 2,90 |



METER/METER

| Abmessungen in mm Size/Dimension/Tamaño | kg | FASSCO Nr./No. | €/Meter mètre/metro |
|--|-------|-------------------|------------------------|
| 10 x 3 | 0,042 | 2000.9910.302 | 2,60 |
| 11 x 3 | 0,046 | 2000.9911.302 | 2,60 |
| 12 x 3 | 0,051 | 2000.9912.302 | 2,70 |
| 13 x 3 | 0,055 | 2000.9913.302 | 3,15 |
| 14 x 3 | 0,059 | 2000.9914.302 | 3,15 |
| 9 x 4 | 0,050 | 2000.9909.402 | 2,65 |
| 10 x 4 sinus | 0,056 | 2000.9910.402 | 2,65 |
| 10 x 4 | 0,056 | 2000.9910.432 | 2,65 |
| 11 x 4 | 0,062 | 2000.9911.402 | 3,60 |
| 12 x 4 | 0,067 | 2000.9912.402 | 3,60 |
| 13 x 4 | 0,073 | 2000.9913.402 | 3,60 |
| 14 x 4 | 0,078 | 2000.9914.402 | 3,60 |
| 15 x 4 | 0,084 | 2000.9915.402 | 4,00 |
| 18 x 4 | 0,101 | 2000.9918.402 | 3,40 |
| 20 x 4 | 0,112 | 2000.9920.402 | 4,60 |
| 24 x 4 | 0,134 | 2000.9924.402 | 4,60 |
| 41 x 4 | 0,230 | 2000.9941.402 | 7,90 |
| 42 x 4 | 0,235 | 2000.9942.402 | 7,90 |
| 60 x 4 | 0,336 | 2000.9960.402 | 8,85 |
| 10 x 4,5 sinus | 0,063 | 2000.9910.412 | 2,65 |
| 10 x 4,5 | 0,063 | 2000.9910.422 | 2,65 |
| 9 x 5 | 0,063 | 2000.9909.502 | 4,10 |
| 10 x 5 | 0,070 | 2000.9910.502 | 4,10 |
| 14 x 5 | 0,098 | 2000.9914.502 | 4,60 |
| 15 x 5 | 0,105 | 2000.9915.502 | 4,60 |
| 16 x 5 | 0,112 | 2000.9916.502 | 4,60 |
| 18 x 5 | 0,126 | 2000.9918.502 | 4,60 |
| 18 x 6 | 0,151 | 2000.9918.602 | 6,35 |
| 19 x 6 aK | 0,160 | 2000.9919.602 | 6,35 |
| 20 x 10 | 0,280 | 2000.9920.102 | 6,35 |
| 10 x 10 | 0,140 | 2000.9910.002 | 5,20 |
| 12 x 12 | 0,202 | 2000.9912.002 | 5,20 |
| 12,5 x 12,5 | 0,219 | 2000.9912.052 | 6,10 |
| 12,7 x 12,7 | 0,230 | 2000.9912.072 | 6,10 |
| 13 x 13 | 0,237 | 2000.9913.002 | 6,10 |
| 14 x 14 | 0,274 | 2000.9914.002 | 7,35 |
| 14 x 14 KL | 0,274 | 2000.9914.012 | 8,85 |
| 15 x 15 | 0,315 | 2000.9915.002 | 8,20 |
| 16 x 16 | 0,358 | 2000.9916.002 | 9,15 |
| 17 x 17 | 0,405 | 2000.9917.002 | 10,65 |
| 18 x 18 | 0,454 | 2000.9918.002 | 10,65 |
| 19 x 19 | 0,505 | 2000.9919.012 | 10,65 |
| 19,05 x 19,05 | 0,508 | 2000.9919.002 | 10,65 |
| 20 x 20 | 0,560 | 2000.9920.002 | 22,50 |
| 25 x 25 | 0,875 | 2000.9925.002 | 24,30 |

Preise per Meter für Längen ab 500 mm / Länge 250 – 499 mm +10% Aufschlag, Länge < 250 mm Preis auf Anfrage
Prices per meter for lengths from 500 mm / Length 250 – 499 mm +10% increase, length < 250 mm price on request

* Preis auf Anfrage / Price on request

www.fassco.de | 219

FASSCO-EISHOBELMESSER

sportgerechtes Eis mit FASSCO-Eishobelmesser für alle Eisbearbeitungsmaschinen

FASSCO LCE PLANING KNIVES

for sport installations



EISBÄR

| Maschinen-Type Type/Type/Tipo | Abmessungen in mm Size/Dimension/Tamaño | Löcher/Holes Trous/Huecos | ⚖ kg | FASSCO-Id. Qualität/Quality/Calid. | €/Stück Pce./Pce./Pza. |
|----------------------------------|--|------------------------------|---------|---------------------------------------|---------------------------|
| EISBÄR 1995 | 1995 x 128 x 12,5 | 20 vers.Lö. 2/M12 | 22,10 | 603.01F25E | 678,00 |
| EISBÄR 2212 | 2212 x 128 x 12,5 | 22 vers.Lö. 2/M12 | 24,50 | 603.02F25E | 742,00 |

ENGO

| Maschinen-Type Type/Type/Tipo | Abmessungen in mm Size/Dimension/Tamaño | Löcher/Holes Trous/Huecos | ⚖ kg | FASSCO-Id. Qualität/Quality/Calid. | €/Stück Pce./Pce./Pza. |
|----------------------------------|--|---------------------------------|---------|---------------------------------------|---------------------------|
| ENGO 1980 | 1978 x 140 x 14 | 20 vers.Lö. 2/M10 | 26,70 | 606.03F25E | 811,00 |
| ENGO 230 Me-230 LX Elettra | 2260 x 125 x 14/8 | 9/Ø11,5 1/Ø15 2/M10, 3/M6 | 22,10 | 606.05F25E | 1010,00 |
| ENGO 2500 | 2496 x 128 x 12,6 | 22 vers.Lö. 2/M10 | 28,10 | 606.01F25E | 858,00 |
| ENGO 2500 | 2496 x 130 x 14 | 22 vers.Lö. 2/M10 | 33,70 | 606.02F25E | 946,00 |

MULSER

(ZüKo)

| Maschinen-Type Type/Type/Tipo | Abmessungen in mm Size/Dimension/Tamaño | Löcher/Holes Trous/Huecos | ⚖ kg | FASSCO-Id. Qualität/Quality/Calid. | €/Stück Pce./Pce./Pza. |
|----------------------------------|--|---------------------------------|---------|---------------------------------------|---------------------------|
| WM 2060 WM 2070 | 2064 x 42/45/42 x 3,8 | | 2,50 | 605.05F431 | 401,00 |
| WM 2300 | 2294 x 42/45/42 x 3,8 | | 2,80 | 605.04F431 | 407,00 |
| WM 2300 | 2294 x 47/50/47 x 3,8 | 2/6 Ø 5/4 Ø | 3,10 | 605.08F431 | 431,00 |
| WM 2300 Z-SZ | 2294 x 52/55/52 x 3,8 | 2/6,2 Ø 5/3,4/7 Ø 4/3,4 Ø | 3,45 | 605.11F431 | 443,00 |
| WM 2060 | 2064 x 42/45/42 x 3,8 (8x230/2x112) geteilt/ divided | | 2,50 | 605.06F431 | 454,00 |
| WM 2300 | 2294 x 42/45/42 x 3,8 (9x230/2x112) geteilt/ divided | | 2,80 | 605.01F431 | 475,00 |
| 1700 Mini | 1695 x 122 x 12 | 11 vers.Lö. | 17,37 | 605.02F25E | 609,00 |
| 1700 | 1695 x 150 x 10 | 22 vers.Lö. | 17,20 | 605.07F25E | 692,00 |

OKAY-DUPON

| Maschinen-Type Type/Type/Tipo | Abmessungen in mm Size/Dimension/Tamaño | Löcher/Holes Trous/Huecos | ⚖ kg | FASSCO-Id. Qualität/Quality/Calid. | €/Stück Pce./Pce./Pza. |
|----------------------------------|--|------------------------------|---------|---------------------------------------|---------------------------|
| OKAY | 1998 x 70 x 12 | | 11,70 | 601.01F25E | 406,00 |

OLYMPIA

| Maschinen-Type Type/Type/Tipo | Abmessungen in mm Size/Dimension/Tamaño | Löcher/Holes Trous/Huecos | △ kg | FASSCO-Id. Qualität/Quality/Calid. | €/Stück Pce./Pce./Pza. |
|----------------------------------|---|------------------------------|---------|---------------------------------------|---------------------------|
| Olympia 80" | 2032 x 127 x 12,7 (80" x 5" x 1/2") | 28 vers.Lö. | 22,90 | 604.03F25E | 713,00 |
| Olympia 84" | 2134 x 127 x 12,7 (84" x 5" x 1/2") | 24 vers.Lö. | 23,70 | 604.01F25E | 748,00 |
| Olympia 84" | 2134 x 127 x 12,7 (84" x 5" x 1/2") | 24/M12 | 23,70 | 604.05F25E | 748,00 |
| ICEBEAR- Olympia 84" | 2130,5 x 127 x 12,5 (83.7/8" x 5" x .492") | 24 vers.Lö. | 23,30 | 603.05F25E | 748,00 |
| Olympia 96" | 2438 x 127 x 12,7 (96" x 5" x 1/2") | 26 vers.Lö. | 27,40 | 604.02F25E | 837,00 |
| Olympia 96" | 2438 x 127 x 12,7 (96" x 5" x 1/2") | 26/M12 | 27,40 | 604.06F25E | 837,00 |

RINGMASTER

| Maschinen-Type Type/Type/Tipo | Abmessungen in mm Size/Dimension/Tamaño | Löcher/Holes Trous/Huecos | △ kg | FASSCO-Id. Qualität/Quality/Calid. | €/Stück Pce./Pce./Pza. |
|----------------------------------|--|------------------------------|---------|---------------------------------------|---------------------------|
| 3.1/2" | 2032 x 88,9 x 11,1 (80" x 3.1/2" x 7/16") | 14 vers.Lö. | 14,00 | 602.01F25E | 526,00 |
| 4" | 2032 x 101,6 x 12,7 (80" x 4" x 1/2") | 14 vers.Lö. | 18,30 | 602.02F25E | 674,00 |

ZAMBONI (ROLBA / Küpper-Weisser)

| Maschinen-Type Type/Type/Tipo | Abmessungen in mm Size/Dimension/Tamaño | Löcher/Holes Trous/Huecos | △ kg | FASSCO-Id. Qualität/Quality/Calid. | €/Stück Pce./Pce./Pza. |
|----------------------------------|--|------------------------------|---------|---------------------------------------|---------------------------|
| 66" | 1676,4 x 127 x 12,6 (66" x 5" x .495") | 16 vers.Lö. | 18,45 | 600.01F25E | 636,00 |
| 77" | 1955,8 x 127 x 12,6 (77" x 5" x .495") | 20 vers.Lö. | 21,50 | 600.02F25E | 660,00 |
| 86" | 2184,4 x 127 x 12,6 (86" x 5" x .495") | 24 vers.Lö. | 21,50 | 600.11F25E | 815,00 |
| 96" | 2438,4 x 127 x 12,6 (96" x 5" x .495") | 24 vers.Lö. | 26,80 | 600.03F25E | 837,00 |

ZAMBONI (Sondermodell/ Special model)

| Maschinen-Type Type/Type/Tipo | Abmessungen in mm Size/Dimension/Tamaño | Löcher/Holes Trous/Huecos | △ kg | FASSCO-Id. Qualität/Quality/Calid. | €/Stück Pce./Pce./Pza. |
|----------------------------------|--|------------------------------|---------|---------------------------------------|---------------------------|
| 77" | 1955,8 x 127 x 12,6 (77" x 5" x .495") | 20/M12 | 21,50 | 600.05F25E | 646,00 |
| 96" | 2438,4 x 127 x 12,6 (96" x 5" x .495") | 24/M12 | 26,80 | 600.06F25E | 820,00 |

MESSER FÜR SCHULHEFTSTRASSEN

Block- und Durchschreibebücher-Herstellungsmaschinen

KNIVES FOR BOUND NOTEBOOK PRODUCTION LINES

Pad and carbon-copy book production equipment

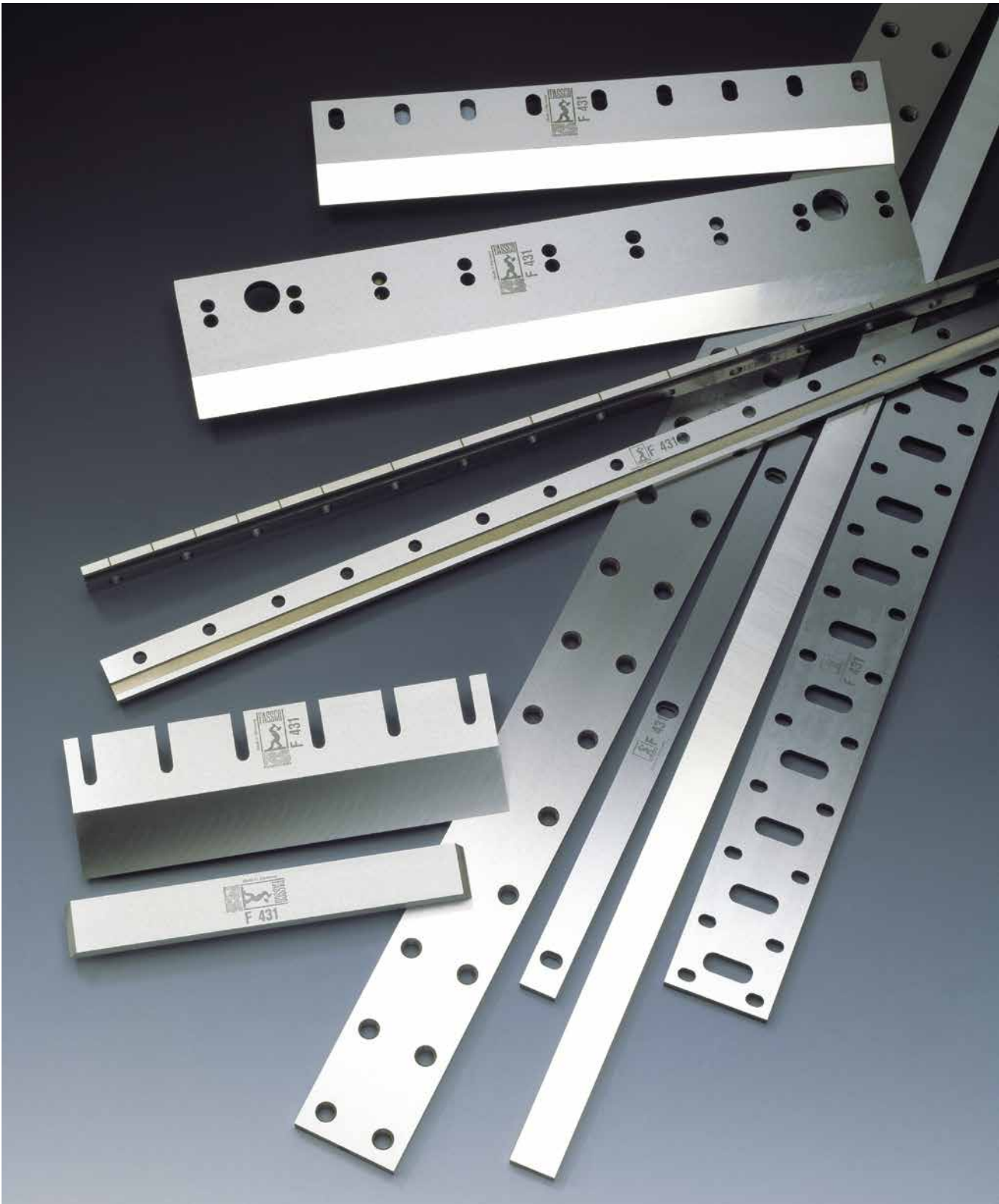

BIELOMATIK

| Original Nr./No. | FASSCO Nr./No. | Qualität Qual./Calid. | | Abmessungen in mm Size/Dimension/Tamaño |
|------------------|----------------|-----------------------|-------------|---|
| 040 00 700 | 45 040 00 700 | F-431 | Leiste | 520 x 31,85 x 18 |
| 040 07 336 | 45 040 07 336 | F-431 | Leiste | 500 x 62,4 x 15 |
| 040 24 030 | 45 040 24 030 | F-431 | Leiste | 927 x 48 x 11 |
| 040 24 051 | 45 040 24 051 | F-431 | Leiste | 897 x 48 x 11 |
| 040 40 188 | 45 040 40 188 | F-431 | Leiste | 2483 x 90 x 20 |
| 040 40 189 | 45 040 40 189 | F-431 | Leiste | 3000 x 90 x 20 |
| 040 40 280 | 45 040 40 280 | F-431 | Leiste | 795 x 100 x 20 |
| 040 40 329 | 45 040 40 329 | F-431 | Leiste | 1540 x 40 x 15 |
| 040 40 439 | 45 040 40 439 | F-431 | Leiste | 1210 x 60 x 15 |
| 040 40 464 | 45 040 40 464 | F-431 | Leiste | 600 x 20 x 9,98 |
| 040 40 482 | 45 040 40 482 | F-431 | Leiste | 1280 x 40 x 15 |
| 040 40 491 | 45 040 40 491 | F-431 | Leiste | 800 x 60 x 15 |
| 066 02 089 | 45 066 02 089 | F-431 | Rakelmesser | 550 x 35 x 6 |
| 066 92 163 | 45 066 92 163 | F-431 | Rakelmesser | 976 x 35 x 6 |
| 070 00 001 | 45 070 00 001 | F-3000 | Obermesser | 220 x 60 x 8 |
| 070 00 001 | 45 070 00 001 | F-431 | Obermesser | 220 x 60 x 8 |
| 070 00 002 | 45 070 00 002 | F-3000 | Obermesser | 250 x 60 x 8 |
| 070 00 002 | 45 070 00 002 | F-431 | Obermesser | 250 x 60 x 8 |
| 070 00 006 | 45 070 00 006 | F-3000 | Obermesser | 350 x 60 x 8 |
| 070 00 006 | 45 070 00 006 | F-431 | Obermesser | 350 x 60 x 8 |
| 070 00 007 | 45 070 00 007 | F-3000 | Obermesser | 380 x 60 x 8 |
| 070 00 007 | 45 070 00 007 | F-431 | Obermesser | 380 x 60 x 8 |
| 070 00 011 | 45 070 00 011 | F-3000 | Obermesser | 580 x 60 x 8 |
| 070 00 011 | 45 070 00 011 | F-431 | Obermesser | 580 x 60 x 8 |
| 070 00 018 | 45 070 00 018 | F-3000 | Obermesser | 350 x 70 x 8 |
| 070 00 018 | 45 070 00 018 | F-431 | Obermesser | 350 x 70 x 8 |
| 070 00 024 | 45 070 00 024 | F-431 | Obermesser | 530 x 90 x 8 |
| 070 00 030 | 45 070 00 030 | F-3000 | Obermesser | 550 x 95 x 15 |
| 070 00 030 | 45 070 00 030 | F-431 | Obermesser | 550 x 95 x 15 |
| 070 00 031 | 45 070 00 031 | F-3000 | Obermesser | 240 x 95 x 15 |
| 070 00 031 | 45 070 00 031 | F-431 | Obermesser | 240 x 95 x 15 |
| 070 00 032 | 45 070 00 032 | F-431 | Obermesser | 525 x 38 x 10 |
| 070 00 035 | 45 070 00 035 | F-431 | Obermesser | 710 x 40 x 6 |
| 070 00 036 | 45 070 00 036 | F-431 | Obermesser | 1050 x 50 x 6 |
| 070 00 040 | 45 070 00 040 | F-431 | Obermesser | 670 x 40 x 10 |
| 070 00 042 | 45 070 00 042 | F-431 | Obermesser | 540 x 95 x 15 |
| 070 00 044 | 45 070 00 044 | F-431 | Messer | 1450 x 60 x 6 |
| 070 00 047 | 45 070 00 047 | F-3000 | Obermesser | 765 x 95 x 15 |
| 070 00 047 | 45 070 00 047 | F-431 | Obermesser | 765 x 95 x 15 |
| 070 00 048 | 45 070 00 048 | F-3000 | Obermesser | 280 x 95 x 15 |
| 070 00 048 | 45 070 00 048 | F-431 | Obermesser | 280 x 95 x 15 |
| 070 00 049 | 45 070 00 049 | F-431 | Obermesser | 1150 x 50 x 8 |
| 070 00 051 | 45 070 00 051 | F-3000 | Obermesser | 1135 x 120 x 20 |
| 070 00 051 | 45 070 00 051 | F-431 | Obermesser | 1135 x 120 x 20 |
| 070 00 052 | 45 070 00 052 | F-431 | Obermesser | 1150 x 50 x 6 |
| 070 00 053 | 45 070 00 053 | F-3000 | Obermesser | 1030 x 120 x 20 |
| 070 00 053 | 45 070 00 053 | F-431 | Obermesser | 1030 x 120 x 20 |

| Original Nr./No. | FASSCO Nr./No. | Qualität Qual./Calid. | | Abmessungen in mm Size/Dimension/Tamaño |
|------------------|----------------|-----------------------|------------|---|
| 070 00 054 | 45 070 00 054 | F-3000 | Obermesser | 260 x 60 x 8 |
| 070 00 054 | 45 070 00 054 | F-431 | Obermesser | 260 x 60 x 8 |
| 070 00 055 | 45 070 00 055 | F-3000 | Obermesser | 720 x 60 x 8 |
| 070 00 055 | 45 070 00 055 | F-431 | Obermesser | 720 x 60 x 8 |
| 070 00 057 | 45 070 00 057 | F-431 | Obermesser | 700 x 40 x 6 |
| 070 00 059 | 45 070 00 059 | F-431 | Obermesser | 1150 x 50 x 8 |
| 070 00 061 | 45 070 00 061 | F-3000 | Obermesser | 1200 x 95 x 15 |
| 070 00 061 | 45 070 00 061 | F-431 | Obermesser | 1200 x 95 x 15 |
| 070 00 062 | 45 070 00 062 | F-431 | Obermesser | 1080 x 40 x 6 |
| 070 00 064 | 45 070 00 064 | F-431 | Obermesser | 1150 x 50 x 8 |
| 070 00 065 | 45 070 00 065 | F-431 | Obermesser | 700 x 35 x 5 |
| 070 00 067 | 45 070 00 067 | F-431 | Obermesser | 550 x 50 x 6 |
| 070 00 069 | 45 070 00 069 | F-3000 | Obermesser | 280 x 95 x 15 |
| 070 00 069 | 45 070 00 069 | F-431 | Obermesser | 280 x 95 x 15 |
| 070 00 070 | 45 070 00 070 | F-431 | Obermesser | 1180 x 40 x 6 |
| 070 00 071 | 45 070 00 071 | F-431 | Obermesser | 1450 x 60 x 11,5/8,4 |
| 070 00 073 | 45 070 00 073 | F-3000 | Obermesser | 740 x 95 x 15 |
| 070 00 073 | 45 070 00 073 | F-431 | Obermesser | 740 x 95 x 15 |
| 070 00 074 | 45 070 00 074 | F-431 | Obermesser | 1148 x 50 x 8 |
| 070 00 075 | 45 070 00 075 | F-3000 | Obermesser | 240 x 70 x 8 |
| 070 00 075 | 45 070 00 075 | F-431 | Obermesser | 240 x 70 x 8 |
| 070 00 076 | 45 070 00 076 | F-431 | Obermesser | 770 x 50 x 6 |
| 070 00 077 | 45 070 00 077 | F-3000 | Obermesser | 740 x 95 x 15 |
| 070 00 077 | 45 070 00 077 | F-431 | Obermesser | 740 x 95 x 15 |
| 070 00 078 | 45 070 00 078 | F-3000 | Obermesser | 280 x 95 x 15 |
| 070 00 078 | 45 070 00 078 | F-431 | Obermesser | 280 x 95 x 15 |
| 070 00 079 | 45 070 00 079 | F-8000 | Obermesser | 280 x 95 x 15 |
| 070 00 080 | 45 070 00 080 | F-431 | Obermesser | 1450 x 61 x 12 |
| 070 00 092 | 45 070 00 092 | F-431 | Obermesser | 738 x 50 x 8 |
| 070 00 095 | 45 070 00 095 | F-431 | Obermesser | 1398 x 50 x 8 |
| 070 00 097 | 45 070 00 097 | F-3000 | Obermesser | 1460 x 95 x 15 |
| 070 00 097 | 45 070 00 097 | F-431 | Obermesser | 1460 x 95 x 15 |
| 070 00 098 | 45 070 00 098 | F-3000 | Obermesser | 254 x 70 x 8 |
| 070 00 098 | 45 070 00 098 | F-431 | Obermesser | 254 x 70 x 8 |
| 070 00 099 | 45 070 00 099 | F-3000 | Obermesser | 1200 x 95 x 15 |
| 070 00 099 | 45 070 00 099 | F-431 | Obermesser | 1200 x 95 x 15 |
| 070 00 101 | 45 070 00 101 | F-3000 | Obermesser | 800 x 105 x 15 |
| 070 00 101 | 45 070 00 101 | F-431 | Obermesser | 800 x 105 x 15 |
| 070 00 103 | 45 070 00 103 | F-3000 | Obermesser | 1210 x 105 x 15 |
| 070 00 103 | 45 070 00 103 | F-431 | Obermesser | 1210 x 105 x 15 |
| 070 00 104 | 45 070 00 104 | F-431 | Obermesser | 75 x 55/50 x 5 |
| 070 00 105 | 45 070 00 105 | F-431 | Obermesser | 1210 x 105 x 15 |
| 070 00 108 | 45 070 00 108 | F-3000 | Obermesser | 340 x 80 x 10 |
| 070 00 108 | 45 070 00 108 | F-431 | Obermesser | 340 x 80 x 10 |
| 070 00 115 | 45 070 00 115 | F-3000 | Obermesser | 260 x 90 x 10 |
| 070 00 115 | 45 070 00 115 | F-431 | Obermesser | 260 x 90 x 10 |
| 070 00 116 | 45 070 00 116 | F-3000 | Obermesser | 360 x 90 x 10 |

BIELOMATIK

| Original Nr./No. | FASSCO Nr./No. | Qualität Qual./Calid. | | Abmessungen in mm Size/Dimension/Tamaño |
|------------------|----------------|-----------------------|-------------|---|
| 070 00 116 | 45 070 00 116 | F-431 | Obermesser | 360 x 90 x 10 |
| 070 00 117 | 45 070 00 117 | F-431 | Obermesser | 686 x 44 x 10 |
| 070 00 165 | 45 070 00 165 | F-431 | Obermesser | 1148 x 50 x 8 |
| 070 00 169 | 45 070 00 169 | F-8000 | Obermesser | 520 x 19 x 2,1 |
| 070 00 179 | 45 070 00 179 | F-3000 | Obermesser | 670 x 105 x 15 |
| 070 00 179 | 45 070 00 179 | F-431 | Obermesser | 670 x 105 x 15 |
| 070 00 182 | 45 070 00 182 | F-431 | Obermesser | 722 x 105 x 10 |
| 070 00 186 | 45 070 00 186 | F-431 | Obermesser | 798 x 32 x 6/2 |
| 070 00 186 | 45 070 00 186 | F-4002 | Obermesser | 798 x 32 x 6/2 |
| 070 00 187 | 45 070 00 187 | F-431 | Obermesser | 850 x 45 x 8 |
| 070 00 188 | 45 070 00 188 | F-431 | Obermesser | 850 x 65/46 x 6 |
| 070 00 189 | 45 070 00 189 | F-431 | Obermesser | 260 x 90 x 10 |
| 070 00 190 | 45 070 00 190 | F-431 | Obermesser | 260 x 90 x 10 |
| 070 00 191 | 45 070 00 191 | F-4002 | Obermesser | 738 x 50 x 8 |
| 070 00 192 | 45 070 00 192 | F-4002 | Obermesser | 1148 x 50 x 8 |
| 070 00 195 | 45 070 00 195 | F-8000 | Obermesser | 1218 x 50 x 8 |
| 070 00 215 | 45 070 00 215 | F-431 | Obermesser | 260 x 90 x 10 |
| 070 00 216 | 45 070 00 216 | F-431 | Obermesser | 260 x 90 x 10 |
| 070 00 218 | 45 070 00 218 | F-4002 | Obermesser | 573 x 50 x 8 |
| 070 00 220 | 45 070 00 220 | F-8000 | Obermesser | 440 x 45 x 6 |
| 070 00 221 | 45 070 00 221 | F-431 | Obermesser | 530 x 45 x 6 |
| 070 00 221 | 45 070 00 221 | F-8000 | Obermesser | 530 x 45 x 6 |
| 070 00 226 | 45 070 00 226 | F-8000 | Obermesser | 528 x 45 x 6 |
| 070 00 227 | 45 070 00 227 | F-4002 | Obermesser | 538 x 50 x 8 |
| 070 00 229 | 45 070 00 229 | F-4002 | Obermesser | 478 x 45 x 6 |
| 070 00 229 | 45 070 00 229 | F-8000 | Obermesser | 478 x 45 x 6 |
| 070 00 231 | 45 070 00 231 | F-431 | Obermesser | 1218 x 50 x 8 |
| 070 00 232 | 45 070 00 232 | F-431 | Obermesser | 528 x 45 x 6 |
| 070 00 232 | 45 070 00 232 | F-8000 | Obermesser | 528 x 45 x 6 |
| 070 00 235 | 45 070 00 235 | F-8000 | Obermesser | 480 x 45 x 6 |
| 070 00 403 | 45 070 00 403 | F-431 | Untermesser | 850 x 65/46 x 6 |
| 070 00 404 | 45 070 00 404 | F-431 | Obermesser | 798 x 32 x 6/2 |
| 070 00 404 | 45 070 00 404 | F-4002 | Obermesser | 798 x 32 x 6/2 |
| 070 00 405 | 45 070 00 405 | F-431 | Obermesser | 850 x 32 x 6/2 |
| 070 00 405 | 45 070 00 405 | F-4002 | Obermesser | 850 x 32 x 6/2 |
| 070 00 406 | 45 070 00 406 | F-431 | Untermesser | 850 x 65/56/46 x 6 |
| 070 00 407 | 45 070 00 407 | F-431 | Obermesser | 850 x 32 x 6/2 |
| 070 00 407 | 45 070 00 407 | F-4002 | Obermesser | 850 x 32 x 6/2 |
| 070 00 408 | 45 070 00 408 | F-431 | Obermesser | 798 x 32 x 6/2 |
| 070 00 408 | 45 070 00 408 | F-4002 | Obermesser | 798 x 32 x 6/2 |
| 070 00 409 | 45 070 00 409 | F-431 | Obermesser | 850 x 32 x 6/2 |
| 070 00 409 | 45 070 00 409 | F-4002 | Obermesser | 850 x 32 x 6/2 |
| 070 00 411 | 45 070 00 411 | F-431 | Obermesser | 850 x 32 x 6/2 |
| 070 00 411 | 45 070 00 411 | F-4002 | Obermesser | 850 x 32 x 6/2 |
| 070 00 412 | 45 070 00 412 | F-431 | Obermesser | 798 x 32 x 6/2 |
| 070 00 412 | 45 070 00 412 | F-4002 | Obermesser | 798 x 32 x 6/2 |
| 070 00 413 | 45 070 00 413 | F-431 | Obermesser | 872 x 32 x 6/2 |

| Original Nr./No. | FASSCO Nr./No. | Qualität Qual./Calid. | | Abmessungen in mm Size/Dimension/Tamaño |
|------------------|----------------|-----------------------|-------------|---|
| 070 00 413 | 45 070 00 413 | F-4002 | Obermesser | 872 x 32 x 6/2 |
| 070 00 414 | 45 070 00 414 | F-431 | Obermesser | 940 x 32 x 6/2 |
| 070 00 414 | 45 070 00 414 | F-4002 | Obermesser | 940 x 32 x 6/2 |
| 070 00 419 | 45 070 00 419 | F-431 | Obermesser | 798 x 32 x 6/2 |
| 070 00 419 | 45 070 00 419 | F-4002 | Obermesser | 798 x 32 x 6/2 |
| 070 00 420 | 45 070 00 420 | F-4002 | Obermesser | 940 x 32 x 6/2 |
| 070 02 003 | 45 070 02 003 | F-431 | Untermesser | 230 x 40 x 10 |
| 070 02 006 | 45 070 02 006 | F-431 | Untermesser | 320 x 40 x 10 |
| 070 02 009 | 45 070 02 009 | F-431 | Untermesser | 530 x 40 x 10 |
| 070 02 013 | 45 070 02 013 | F-431 | Untermesser | 800 x 40 x 10 |
| 070 02 015 | 45 070 02 015 | F-431 | Untermesser | 230 x 40 x 10 |
| 070 02 016 | 45 070 02 016 | F-431 | Untermesser | 530 x 40 x 10 |
| 070 02 017 | 45 070 02 017 | F-431 | Untermesser | 660 x 40 x 10 |
| 070 02 018 | 45 070 02 018 | F-431 | Untermesser | 700 x 45 x 10 |
| 070 02 019 | 45 070 02 019 | F-431 | Untermesser | 700 x 40 x 6 |
| 070 02 021 | 45 070 02 021 | F-431 | Untermesser | 300 x 60 x 10 |
| 070 02 023 | 45 070 02 023 | F-431 | Untermesser | 525 x 40 x 10 |
| 070 02 024 | 45 070 02 024 | F-431 | Untermesser | 710 x 45 x 10 |
| 070 02 025 | 45 070 02 025 | F-431 | Untermesser | 1050 x 50 x 10 |
| 070 02 026 | 45 070 02 026 | F-431 | Untermesser | 470 x 60 x 10 |
| 070 02 027 | 45 070 02 027 | F-431 | Untermesser | 300 x 65 x 10 |
| 070 02 029 | 45 070 02 029 | F-431 | Untermesser | 500 x 60 x 10 |
| 070 02 033 | 45 070 02 033 | F-431 | Untermesser | 700 x 60 x 10 |
| 070 02 034 | 45 070 02 034 | F-431 | Untermesser | 710 x 60 x 10 |
| 070 02 035 | 45 070 02 035 | F-431 | Untermesser | 315 x 55 x 15 |
| 070 02 037 | 45 070 02 037 | F-431 | Untermesser | 1160 x 60 x 15 |
| 070 02 038 | 45 070 02 038 | F-431 | Untermesser | 1150 x 50 x 10 |
| 070 02 039 | 45 070 02 039 | F-431 | Untermesser | 980 x 70 x 15 |
| 070 02 041 | 45 070 02 041 | F-431 | Untermesser | 700 x 16 x 6 |
| 070 02 043 | 45 070 02 043 | F-431 | Untermesser | 1150 x 50 x 8 |
| 070 02 044 | 45 070 02 044 | F-431 | Untermesser | 280 x 40 x 10 |
| 070 02 045 | 45 070 02 045 | F-431 | Untermesser | 1170 x 70 x 12 |
| 070 02 046 | 45 070 02 046 | F-431 | Untermesser | 404 x 35 x 12 |
| 070 02 047 | 45 070 02 047 | F-431 | Untermesser | 1080 x 40 x 10 |
| 070 02 048 | 45 070 02 048 | F-431 | Untermesser | 700 x 26 x 8 |
| 070 02 052 | 45 070 02 052 | F-431 | Untermesser | 1180 x 40 x 10 |
| 070 02 053 | 45 070 02 053 | F-431 | Untermesser | 1450 x 35 x 11,2/9,5 |
| 070 02 054 | 45 070 02 054 | F-431 | Untermesser | 700 x 60 x 10 |
| 070 02 055 | 45 070 02 055 | F-431 | Untermesser | 1148 x 50 x 8 |
| 070 02 056 | 45 070 02 056 | F-431 | Untermesser | 770 x 45 x 10 |
| 070 02 063 | 45 070 02 063 | F-431 | Untermesser | 265 x 26 x 12 |
| 070 02 064 | 45 070 02 064 | F-431 | Untermesser | 766 x 50 x 8 |
| 070 02 065 | 45 070 02 065 | F-431 | Untermesser | 1398 x 50 x 8 |
| 070 02 066 | 45 070 02 066 | F-431 | Untermesser | 1430 x 70 x 12 |
| 070 02 067 | 45 070 02 067 | F-431 | Untermesser | 280 x 26 x 12 |
| 070 02 068 | 45 070 02 068 | F-431 | Untermesser | 400 x 20 x 10 |
| 070 02 070 | 45 070 02 070 | F-431 | Untermesser | 770 x 70 x 12 |

BIELOMATIK

| Original Nr./No. | FASSCO Nr./No. | Qualität Qual./Calid. | | Abmessungen in mm Size/Dimension/Tamaño |
|------------------|----------------|-----------------------|-----------------|---|
| 070 02 071 | 45 070 02 071 | F-431 | Untermesser | 1170 x 70 x 12 |
| 070 02 073 | 45 070 02 073 | F-431 | Untermesser | 120 x 11 x 3 |
| 070 02 074 | 45 070 02 074 | F-431 | Untermesser | 425 x 25 x 10 |
| 070 02 075 | 45 070 02 075 | F-8000 | Untermesser | 360 x 40 x 10 |
| 070 02 076 | 45 070 02 076 | F-431 | Untermesser | 1230 x 50 x 8 |
| 070 02 078 | 45 070 02 078 | F-431 | Untermesser | 360 x 35 x 12 |
| 070 02 079 | 45 070 02 079 | F-431 | Untermesser | 766 x 50 x 8 |
| 070 02 080 | 45 070 02 080 | F-431 | Untermesser | 685 x 62/50/40 x 8 |
| 070 02 081 | 45 070 02 081 | F-431 | Untermesser | 1148 x 50 x 8 |
| 070 02 083 | 45 070 02 083 | F-431 | Untermesser | 440 x 25 x 10 |
| 070 02 085 | 45 070 02 085 | F-431 | Untermesser | 450 x 24 x 10 |
| 070 02 089 | 45 070 02 089 | F-431 | Untermesser | 1148 x 50 x 8 |
| 070 02 095 | 45 070 02 095 | F-431 | Untermesser | 720 x 50 x 10 |
| 070 02 100 | 45 070 02 100 | F-431 | Untermesser | 530 x 50 x 8 |
| 070 02 100 | 45 070 02 100 | F-8000 | Untermesser | 530 x 50 x 8 |
| 070 02 101 | 45 070 02 101 | F-431 | Untermesser | 530 x 50 x 8 |
| 070 02 102 | 45 070 02 102 | F-431 | Untermesser | 760 x 50 x 10 |
| 070 02 104 | 45 070 02 104 | F-431 | Untermesser | 798 x 32 x 6/2 |
| 070 02 104 | 45 070 02 104 | F-4002 | Untermesser | 798 x 32 x 6/2 |
| 070 02 106 | 45 070 02 106 | F-431 | Untermesser | 1218 x 50 x 8 |
| 070 02 109 | 45 070 02 109 | F-431 | Untermesser | 394 x 35 x 12 |
| 070 02 112 | 45 070 02 112 | F-4002 | Untermesser | 766 x 50 x 8 |
| 070 02 113 | 45 070 02 113 | F-4002 | Untermesser | 1148 x 50 x 8 |
| 070 02 117 | 45 070 02 117 | F-431 | Untermesser | 371 x 30 x 15 |
| 070 02 405 | 45 070 02 405 | F-431 | Gegenmesser | 570 x 40 x 12 |
| 070 02 406 | 45 070 02 406 | F-431 | Untermesser | 850 x 32 x 6/2 |
| 070 02 406 | 45 070 02 406 | F-4002 | Untermesser | 850 x 32 x 6/2 |
| 070 02 407 | 45 070 02 407 | F-431 | Obermesser | 850 x 45 x 8 |
| 070 02 408 | 45 070 02 408 | F-431 | Untermesser | 850 x 32 x 6/2 |
| 070 02 408 | 45 070 02 408 | F-4002 | Untermesser | 850 x 32 x 6/2 |
| 070 02 410 | 45 070 02 410 | F-431 | Untermesser | 872 x 32 x 6/2 |
| 070 02 410 | 45 070 02 410 | F-4002 | Untermesser | 872 x 32 x 6/2 |
| 070 02 411 | 45 070 02 411 | F-431 | Untermesser | 940 x 32 x 6/2 |
| 070 02 411 | 45 070 02 411 | F-4002 | Untermesser | 940 x 32 x 6/2 |
| 070 04 001 | 45 070 04 001 | F-431 | Rotationsmesser | 250 x 40 x 10 |
| 070 04 005 | 45 070 04 005 | F-431 | Rotationsmesser | 500 x 40 x 10 |
| 070 04 007 | 45 070 04 007 | F-431 | Rotationsmesser | 650 x 40 x 10 |
| 070 07 016 | 45 070 07 016 | F-431 | Untermesser | 65 x 45 x 17 |
| 070 07 016 | 45 070 07 016 | F-8000 | Untermesser | 65 x 45 x 17 |
| 070 10 001 | 45 070 10 001 | F-431 | Obermesser | 100 x 60 x 8 |
| 070 10 002 | 45 070 10 002 | F-3000 | Obermesser | 440 x 95 x 15 |
| 070 10 002 | 45 070 10 002 | F-431 | Obermesser | 440 x 95 x 15 |
| 070 10 004 | 45 070 10 004 | F-431 | Obermesser | 1470 x 70 x 12 |
| 070 10 006 | 45 070 10 006 | F-3000 | Obermesser | 720 x 80 x 8 |
| 070 10 006 | 45 070 10 006 | F-431 | Obermesser | 720 x 80 x 8 |
| 070 10 007 | 45 070 10 007 | F-3000 | Obermesser | 380 x 80 x 10 |
| 070 10 007 | 45 070 10 007 | F-431 | Obermesser | 380 x 80 x 10 |

| Original Nr./No. | FASSCO Nr./No. | Qualität Qual./Calid. | | Abmessungen in mm Size/Dimension/Tamaño |
|------------------|----------------|-----------------------|------------|---|
| 070 10 009 | 45 070 10 009 | F 431 | Obermesser | 370 x 104 x 15 |
| 070 10 010 | 45 070 10 010 | F-431 | Obermesser | 455 x 95 x 15 |
| 070 10 012 | 45 070 10 012 | F-3000 | Obermesser | 280 x 80 x 10 |
| 070 10 012 | 45 070 10 012 | F-431 | Obermesser | 280 x 80 x 10 |
| 070 10 013 | 45 070 10 013 | F-3000 | Obermesser | 480 x 105 x 15 |
| 070 10 013 | 45 070 10 013 | F-431 | Obermesser | 480 x 105 x 15 |
| 070 10 014 | 45 070 10 014 | F-3000 | Obermesser | 410 x 105 x 10 |
| 070 10 014 | 45 070 10 014 | F-431 | Obermesser | 410 x 105 x 10 |
| 070 10 015 | 45 070 10 015 | F-3000 | Obermesser | 1030 x 140 x 15 |
| 070 10 015 | 45 070 10 015 | F-431 | Obermesser | 1030 x 140 x 15 |
| 070 10 016 | 45 070 10 016 | F-431 | Obermesser | 2200 x 35 x 9/5 |
| 070 10 018 | 45 070 10 018 | F-4010 | Obermesser | 2200 x 35 x 8/5 |
| 070 10 018 | 45 070 10 018 | F-431 | Obermesser | 2200 x 35 x 8/5 |
| 070 10 020 | 45 070 10 020 | F-431 | Obermesser | 1500 x 35 x 8/5 |
| 070 10 021 | 45 070 10 021 | F-3000 | Obermesser | 515 x 105 x 10 |
| 070 10 021 | 45 070 10 021 | F-431 | Obermesser | 515 x 105 x 10 |
| 070 10 022 | 45 070 10 022 | F-431 | Obermesser | 172 x 88 x 8 |
| 070 10 025 | 45 070 10 025 | F-3000 | Obermesser | 370 x 65 x 10 |
| 070 10 025 | 45 070 10 025 | F-431 | Obermesser | 370 x 65 x 10 |
| 070 10 027 | 45 070 10 027 | F-3000 | Obermesser | 270 x 65 x 10 |
| 070 10 027 | 45 070 10 027 | F-431 | Obermesser | 270 x 65 x 10 |
| 070 10 029 | 45 070 10 029 | F-3000 | Obermesser | 250 x 105 x 10 |
| 070 10 029 | 45 070 10 029 | F-431 | Obermesser | 250 x 105 x 10 |
| 070 10 030 | 45 070 10 030 | F-3000 | Obermesser | 120 x 88 x 8 |
| 070 10 030 | 45 070 10 030 | F-431 | Obermesser | 120 x 88 x 8 |
| 070 10 031 | 45 070 10 031 | F-431 | Obermesser | 1650 x 35 x 8/5 |
| 070 10 032 | 45 070 10 032 | F-3000 | Obermesser | 340 x 95 x 12 |
| 070 10 032 | 45 070 10 032 | F-431 | Obermesser | 340 x 95 x 12 |
| 070 10 035 | 45 070 10 035 | F-431 | Messer | 1200 x 60 x 1,5 |
| 070 10 037 | 45 070 10 037 | F-8000 | Obermesser | 370 x 65 x 10 |
| 070 10 039 | 45 070 10 039 | F-3000 | Obermesser | 340 x 80 x 10 |
| 070 10 039 | 45 070 10 039 | F-431 | Obermesser | 340 x 80 x 10 |
| 070 10 040 | 45 070 10 040 | F-3000 | Obermesser | 180 x 120 x 15 |
| 070 10 040 | 45 070 10 040 | F-431 | Obermesser | 180 x 120 x 15 |
| 070 10 041 | 45 070 10 041 | F-3000 | Obermesser | 760 x 120 x 10 |
| 070 10 041 | 45 070 10 041 | F-431 | Obermesser | 760 x 120 x 10 |
| 070 10 042 | 45 070 10 042 | F-431 | Obermesser | 1650 x 35 x 8/5 |
| 070 10 045 | 45 070 10 045 | F-3000 | Obermesser | 320 x 80 x 10 |
| 070 10 045 | 45 070 10 045 | F-431 | Obermesser | 320 x 80 x 10 |
| 070 10 046 | 45 070 10 046 | F-431 | Obermesser | 2150 x 35 x 8/5 |
| 070 10 046 | 45 070 10 046 | F-4002 | Obermesser | 2150 x 35 x 8/5 |
| 070 10 047 | 45 070 10 047 | F-3000 | Obermesser | 440 x 80 x 10 |
| 070 10 047 | 45 070 10 047 | F-431 | Obermesser | 440 x 80 x 10 |
| 070 10 048 | 45 070 10 048 | F-431 | Obermesser | 2200 x 35 x 8/5 |
| 070 10 049 | 45 070 10 049 | F-431 | Obermesser | 2200 x 35 x 8/5 |
| 070 10 050 | 45 070 10 050 | F-3000 | Obermesser | 1475 x 100 x 15 |
| 070 10 050 | 45 070 10 050 | F-431 | Obermesser | 1475 x 100 x 15 |

BIELOMATIK

| Original Nr./No. | FASSCO Nr./No. | Qualität Qual./Calid. | | Abmessungen in mm Size/Dimension/Tamaño |
|------------------|----------------|-----------------------|-------------------|---|
| 070 10 051 | 45 070 10 051 | F-3000 | Obermesser | 140 x 100 x 15 |
| 070 10 051 | 45 070 10 051 | F-431 | Obermesser | 140 x 100 x 15 |
| 070 10 053 | 45 070 10 053 | F-431 | Obermesser | 80 x 80 x 10 |
| 070 10 055 | 45 070 10 055 | F-431 | Obermesser | 120 x 50 x 6,35 |
| 070 10 055V | 45 070 10 055V | F-431 | Obermesser | 120 x 50 x 6,35 |
| 070 10 056 | 45 070 10 056 | F-431 | Obermesser | 120 x 50 x 3,175 |
| 070 10 058 | 45 070 10 058 | F-3000 | Obermesser links | 440 x 80 x 10 |
| 070 10 058 | 45 070 10 058 | F-431 | Obermesser links | 440 x 80 x 10 |
| 070 10 059 | 45 070 10 059 | F-3000 | Obermesser rechts | 440 x 80 x 10 |
| 070 10 059 | 45 070 10 059 | F-431 | Obermesser rechts | 440 x 80 x 10 |
| 070 10 060 | 45 070 10 060 | F-431 | Obermesser | 1650 x 35 x 8/5 |
| 070 10 061 | 45 070 10 061 | F-431 | Obermesser | 1800 x 35 x 8/5 |
| 070 10 063 | 45 070 10 063 | F-3000 | Obermesser rechts | 190 x 80 x 10 |
| 070 10 063 | 45 070 10 063 | F-431 | Obermesser rechts | 190 x 80 x 10 |
| 070 10 066 | 45 070 10 066 | F-3000 | Obermesser links | 190 x 80 x 10 |
| 070 10 066 | 45 070 10 066 | F-431 | Obermesser links | 190 x 80 x 10 |
| 070 10 067 | 45 070 10 067 | F-3000 | Obermesser | 1150 x 100 x 10 |
| 070 10 067 | 45 070 10 067 | F-431 | Obermesser | 1150 x 100 x 10 |
| 070 10 069 | 45 070 10 069 | F-431 | Obermesser | 2150 x 35 8/5 |
| 070 10 070 | 45 070 10 070 | F-431 | Obermesser | 65 x 75 x 5 |
| 070 10 072 | 45 070 10 072 | F-431 | Obermesser rechts | 458 x 80 x 10 |
| 070 10 073 | 45 070 10 073 | F-431 | Obermesser links | 458 x 80 x 10 |
| 070 10 074 | 45 070 10 074 | F-431 | Obermesser | 120 x 80 x 10 |
| 070 10 075 | 45 070 10 075 | F-3000 | Obermesser | 320 x 80 x 10 |
| 070 10 075 | 45 070 10 075 | F-431 | Obermesser | 320 x 80 x 10 |
| 070 10 078 | 45 070 10 078 | F-3000 | Obermesser | 1185 x 120 x 10 |
| 070 10 079 | 45 070 10 079 | F-3000 | Obermesser rechts | 450 x 100 x 10 |
| 070 10 079 | 45 070 10 079 | F-431 | Obermesser rechts | 450 x 100 x 10 |
| 070 10 080 | 45 070 10 080 | F-3000 | Obermesser links | 450 x 100 x 10 |
| 070 10 080 | 45 070 10 080 | F-431 | Obermesser links | 450 x 100 x 10 |
| 070 10 082 | 45 070 10 082 | F-8000 | Obermesser | 200 x 80 x 10 |
| 070 10 085 | 45 070 10 085 | F-3000 | Obermesser | 200 x 80 x 10 |
| 070 10 085 | 45 070 10 085 | F-431 | Obermesser | 200 x 80 x 10 |
| 070 10 086 | 45 070 10 086 | F-3000 | Obermesser | 310 x 76 x 10 |
| 070 10 087 | 45 070 10 087 | F-3000 | Obermesser | 775 x 120 x 10 |
| 070 10 088 | 45 070 10 088 | F-431 | Obermesser | 350 x 120 x 10 |
| 070 10 088 | 45 070 10 088 | F-3000 | Obermesser | 350 x 120 x 10 |
| 070 10 105 | 45 070 10 105 | F-3000 | Obermesser | 340 x 76 x 10 |
| 070 10 106 | 45 070 10 106 | F-431 | Obermesser | 200 x 100 x 10 |
| 070 10 109 | 45 070 10 109 | F-4010 | Obermesser | 535 x 34,5 x 5,7/5,0 |
| 070 10 115 | 45 070 10 115 | F-8000 | Obermesser | 200 x 100 x 10 |
| 070 10 117 | 45 070 10 117 | F-3000 | Obermesser | 480 x 120 x 10 |
| 070 10 118 | 45 070 10 118 | F-3000 | Obermesser | 510 x 120 x 10 |
| 070 10 119 | 45 070 10 119 | F-431 | Obermesser | 380 x 80/53 x 10/3 |
| 070 10 120 | 45 070 10 120 | F-431 | Obermesser rechts | 450 x 100 x 10 |
| 070 10 121 | 45 070 10 121 | F-431 | Obermesser links | 450 x 100 x 10 |
| 070 10 122 | 45 070 10 122 | F-3000 | Obermesser | 950 x 135 x 15 |

| Original Nr./No. | FASSCO Nr./No. | Qualität Qual./Calid. | | Abmessungen in mm Size/Dimension/Tamaño |
|------------------|----------------|-----------------------|-------------------|---|
| 070 10 123 | 45 070 10 123 | F-3000 | Obermesser | 1245 x 120 x 10 |
| 070 10 126 | 45 070 10 126 | F-431 | Obermesser rechts | 325 x 100 x 10 |
| 070 10 127 | 45 070 10 127 | F-431 | Obermesser links | 325 x 100 x 10 |
| 070 10 131 | 45 070 10 131 | F-431 | Obermesser | 720 x 35 x 8/5 |
| 070 10 132 | 45 070 10 132 | F-3000 | Obermesser | 830 x 120 x 10 |
| 070 10 134 | 45 070 10 134 | F-431 | Untermesser | 360 x 90/63 x 10/3 |
| 070 10 482 | 45 070 10 482 | F-431 | Leiste | 1280 x 40 x 15 |
| 070 12 001 | 45 070 12 001 | F-431 | Untermesser | 120 x 40 x 10 |
| 070 12 002 | 45 070 12 002 | F-431 | Untermesser | 360 x 40 x 10 |
| 070 12 003 | 45 070 12 003 | F-431 | Untermesser | 440 x 60 x 10 |
| 070 12 004 | 45 070 12 004 | F-431 | Untermesser | 1450 x 70 x 12 |
| 070 12 005 | 45 070 12 005 | F-431 | Untermesser | 400 x 40 x 10 |
| 070 12 006 | 45 070 12 006 | F-431 | Untermesser | 750 x 40 x 10 |
| 070 12 008 | 45 070 12 008 | F-431 | Untermesser | 380 x 30 x 15 |
| 070 12 009 | 45 070 12 009 | F-431 | Untermesser | 490 x 50 x 10 |
| 070 12 010 | 45 070 12 010 | F-431 | Untermesser | 750 x 40 x 10 |
| 070 12 011 | 45 070 12 011 | F-431 | Untermesser | 280 x 40 x 10 |
| 070 12 012 | 45 070 12 012 | F-431 | Untermesser | 1500 x 35 x 12,8/8,0 |
| 070 12 013 | 45 070 12 013 | F-431 | Untermesser | 430 x 50 x 13 |
| 070 12 015 | 45 070 12 015 | F-431 | Untermesser | 420 x 50 x 6 |
| 070 12 016 | 45 070 12 016 | F-431 | Untermesser | 1450 x 70 x 12 |
| 070 12 017 | 45 070 12 017 | F-431 | Untermesser | 1060 x 70 x 15 |
| 070 12 018 | 45 070 12 018 | F-8000 | Untermesser | 280 x 40 x 10 |
| 070 12 019 | 45 070 12 019 | F-431 | Untermesser | 2200 x 30 x 10/5 |
| 070 12 021 | 45 070 12 021 | F-4010 | Untermesser | 2200 x 30 x 8/5 |
| 070 12 021 | 45 070 12 021 | F-431 | Untermesser | 2200 x 30 x 8/5 |
| 070 12 022 | 45 070 12 022 | F-431 | Untermesser | 1500 x 30 x 8/5 |
| 070 12 023 | 45 070 12 023 | F-431 | Untermesser | 485 x 30 x 12/10 |
| 070 12 024 | 45 070 12 024 | F-431 | Untermesser | 218 x 32 x 12 |
| 070 12 026 | 45 070 12 026 | F-431 | Untermesser | 200 x 30 x 10 |
| 070 12 028 | 45 070 12 028 | F-431 | Untermesser | 390 x 40 x 12 |
| 070 12 029 | 45 070 12 029 | F-431 | Untermesser | 158 x 32 x 12 |
| 070 12 032 | 45 070 12 032 | F-431 | Untermesser | 450 x 30 x 15 |
| 070 12 033 | 45 070 12 033 | F-431 | Untermesser | 740 x 50 x 12 |
| 070 12 034 | 45 070 12 034 | F-431 | Untermesser | 1650 x 30 x 8/5 |
| 070 12 035 | 45 070 12 035 | F-431 | Untermesser | 2150 x 30 x 8/5 |
| 070 12 035 | 45 070 12 035 | F-4002 | Untermesser | 2150 x 30 x 8/5 |
| 070 12 036 | 45 070 12 036 | F-431 | Untermesser | 2200 x 30 x 8/5 |
| 070 12 037 | 45 070 12 037 | F-431 | Untermesser | 2200 x 30 x 8/5 |
| 070 12 038 | 45 070 12 038 | F-431 | Untermesser | 1555 x 40 x 15 |
| 070 12 039 | 45 070 12 039 | F-431 | Untermesser | 140 x 25 x 12,5 |
| 070 12 041 | 45 070 12 041 | F-431 | Untermesser | 150 x 28 x 12 |
| 070 12 042 | 45 070 12 042 | F-8000 | Untermesser | 150 x 28 x 12 |
| 070 12 043 | 45 070 12 043 | F-431 | Untermesser | 140 x 28 x 12 |
| 070 12 045 | 45 070 12 045 | F-431 | Untermesser | 760 x 50 x 12 |
| 070 12 046 | 45 070 12 046 | F-431 | Untermesser | 1650 x 30 x 8/5 |
| 070 12 047 | 45 070 12 047 | F-431 | Untermesser | 1800 x 30 x 8/5 |

BIELOMATIK

| Original Nr./No. | FASSCO Nr./No. | Qualität Qual./Calid. | | Abmessungen in mm Size/Dimension/Tamaño |
|------------------|----------------|-----------------------|---------------|---|
| 070 12 051 | 45 070 12 051 | F-431 | Untermesser | 1150 x 40 x 10 |
| 070 12 053 | 45 070 12 053 | F-431 | Untermesser | 2150 x 30 x 8/5 |
| 070 12 054 | 45 070 12 054 | F-431 | Untermesser | 1800 x 30 x 8 |
| 070 12 055 | 45 070 12 055 | F-431 | Untermesser | 150 x 40 x 10 |
| 070 12 056 | 45 070 12 056 | F-431 | Untermesser | 2250 x 30 x 8/5 |
| 070 12 057 | 45 070 12 057 | F-431 | Untermesser | 150 x 40 x 10 |
| 070 12 060 | 45 070 12 060 | F-431 | Untermesser | 1170 x 70 x 12 |
| 070 12 061 | 45 070 12 061 | F-8000 | Untermesser | 220 x 40 x 10 |
| 070 12 062 | 45 070 12 062 | F-431 | Untermesser | 220 x 40 x 10 |
| 070 12 063 | 45 070 12 063 | F-431 | Untermesser | 270 x 45 x 10 |
| 070 12 064 | 45 070 12 064 | F-431 | Untermesser | 760 x 70 x 12 |
| 070 12 065 | 45 070 12 065 | F-431 | Untermesser | 450 x 22 x 8 |
| 070 12 077 | 45 070 12 077 | F-431 | Untermesser | 220 x 40 x 10 |
| 070 12 088 | 45 070 12 088 | F-431 | Untermesser | 490 x 70 x 12 |
| 070 12 091 | 45 070 12 091 | F-431 | Untermesser | 1070 x 60 x 20/14,5 |
| 070 12 092 | 45 070 12 092 | F-431 | Untermesser | 1230 x 70 x 12 |
| 070 12 094 | 45 070 12 094 | F-431 | Untermesser | 325 x 22 x 8 |
| 070 12 096 | 45 070 12 096 | F-431 | Untermesser | 810 x 70 x 12 |
| 070 19 001 | 45 070 19 001 | F-431 | Messer | 42 x 29/25 x 6 |
| 070 19 004 | 45 070 19 004 | F-431 | Messer | 52 x 26/20 x 8 |
| 070 19 008 | 45 070 19 008 | F-8000 | Messer | 50 x 50 x 6 |
| 070 19 009 | 45 070 19 009 | F-431 | Obermesser | 25 x 70 x 10 |
| 070 19 010 | 45 070 19 010 | F-431 | Untermesser | 25 x 52 x 10 |
| 070 19 509 | 45 070 19 509 | F-431 | Messer | 50 x 50 x 6 |
| 070 26 490 | 45 070 26 490 | F-431 | Obermesser | 365 x 65,5/56 x 20/3 |
| 070 26 490 | 45 070 26 490 | F-431 | Schnittplatte | 490 x 95 x 26 |
| 070 26 500 | 45 070 26 500 | F-431 | Obermesser | 385 x 65,5/56 x 20/3 |
| 070 26 500 | 45 070 26 500 | F-431 | Schnittplatte | 490 x 95 x 26 |
| 070 32 101 | 45 070 32 101 | F-431 | Prägemesser | 1140 x 24,25 x 5 |
| 070 32 102 | 45 070 32 102 | F-431 | Prägemesser | 740 x 24,25 x 5 |
| 070 32 105 | 45 070 32 105 | F-431 | Prägemesser | 740 x 22,6 x 5 |
| 070 32 106 | 45 070 32 106 | F-431 | Prägemesser | 470 x 24,25 x 5 |
| 070 90 034 | 45 070 90 034 | F-8000 | Obermesser | 530 x 45 x 6 |
| 070 90 067 | 45 070 90 067 | F-4010 | Messer | 530 x 25 x 8/5 |
| 070 90 077 | 45 070 90 077 | F-431 | Untermesser | 440 x 40 x 10 |
| 070 90 135 | 45 070 90 135 | F-431 | Obermesser | 2265 x 35 x 8/5 |
| 070 90 135 | 45 070 90 135 | F-4010 | Obermesser | 2265 x 35 x 8/5 |
| 070 90 145 | 45 070 90 145 | F-8000 | Untermesser | 1060 x 50 x 8 |
| 070 90 146 | 45 070 90 146 | F-8000 | Obermesser | 1050 x 50 x 8 |
| 070 90 171 | 45 070 90 171 | F-431 | Untermesser | 2265 x 30 x 8/5 |
| 070 90 171 | 45 070 90 171 | F-4010 | Untermesser | 2265 x 30 x 8/5 |
| 070 90 210 | 45 070 90 210 | F-431 | Obermesser | 480 x 120 x 10 |
| 070 90 211 | 45 070 90 211 | F-431 | Untermesser | 500 x 35 x 12 |
| 070 90 217 | 45 070 90 217 | F-431 | Untermesser | 440 x 40 x 10 |
| 070 90 265 | 45 070 90 265 | F-431 | Obermesser | 154 x 70 x 10 |
| 070 90 309 | 45 070 90 309 | F-431 | Obermesser | 180 x 35 x 4 |
| 070 90 321 | 45 070 90 321 | F-431 | Untermesser | 370 x 20 x 8 |

| Original Nr./No. | FASSCO Nr./No. | Qualität Qual./Calid. | | Abmessungen in mm Size/Dimension/Tamaño |
|------------------|----------------|-----------------------|-------------|---|
| 070 90 322 | 45 070 90 322 | F-431 | Untermesser | 115 x 20 x 8 |
| 070 90 323 | 45 070 90 323 | F-431 | Obermesser | 370 x 30 x 3 |
| 070 90 325 | 45 070 90 325 | F-431 | Obermesser | 90 x 17 x 3 |
| 070 90 354 | 45 070 90 354 | F-431 | Untermesser | 2910 x 17 x 15 |
| 070 90 363 | 45 070 90 363 | F-431 | Obermesser | 370 x 30 x 3 |
| 070 90 369 | 45 070 90 369 | F-8000 | Obermesser | 1070 x 55 x 8 |
| 070 90 370 | 45 070 90 370 | F-8000 | Untermesser | 1080 x 50 x 8 |
| 070 90 382 | 45 070 90 382 | F-431 | Obermesser | 200 x 100 x 10 |
| 070 90 383 | 45 070 90 383 | F-431 | Obermesser | 200 x 100 x 10 |
| 070 90 391 | 45 070 90 391 | F-431 | Untermesser | 1218 x 50 x 8 |
| 070 90 406 | 455 1706 000 | F-431 | Obermesser | 1730 x 60 x 9,5/5,8 |
| 070 90 407 | 455 2506 000 | F-431 | Obermesser | 2575 x 60 x 9,5 |
| 070 90 408 | 455 2504 101 | F-431 | Untermesser | 2575 x 41 x 9 |
| 070 90 415 | 45 070 90 415 | F-431 | Messer | 180 x 70 x 2 |
| 070 90 424 | 455 0002 700 | F-431 | Flachmesser | 56 x 27/21 x 3 |
| 070 90 427 | 45 070 90 427 | F-431 | Untermesser | 1735 x 32 x 10 |
| 070 90 440 | 45 070 90 440 | F-431 | Obermesser | 2750 x 60 x 12 |
| 070 90 458 | 455 1503 105 | F-431 | Untermesser | 1530 x 35 x 10/6,9 |
| 070 90 477 | 45 070 90 477 | F-431 | Untermesser | 1600 x 60 x 10 |
| 070 90 474 | 455 1703 105 | F-431 | Quermesser | 1735 x 35 x 5 |
| 070 90 487 | 455 2204 101 | F-431 | Untermesser | 2235 x 41 x 9/6 |
| 070 90 490 | 455 1307 103 | F-431 | Untermesser | 1300 x 65 x 16/5 |
| 070 90 491 | 455 2203 113 | F-8000 | Untermesser | 2285 x 38 x 12 |
| 070 90 494 | 455 2204 000 | F-431 | Obermesser | 2235 x 40 x 10/8 |
| 070 90 477 | 45 070 90 477 | F-431 | Untermesser | 1600 x 60 x 10 |
| 070 90 516 | 455 2707 000 | F-431 | Obermesser | 2750 x 70 x 12/9 |
| 070 90 531 | 455 1506 004 | F-431 | Obermesser | 1530 x 60 x 9,5/5,8 |
| 070 90 549 | 455 1306 000 | F-431 | Obermesser | 1300 x 60 x 12 |
| 070 90 550 | 45 070 90 550 | F-431 | Obermesser | 1600 x 80 x 10 |
| 070 90 559 | 455 1709 700 | F-431 | Obermesser | 1730 x 90 x 28/12 |
| 070 90 595 | 455 2205 012 | F-431 | Obermesser | 2235 x 55 x 10 |
| 070 90 596 | 455 2203 111 | F-4002 | Untermesser | 2235 x 32 x 10 |
| 070 90 657 | 455 2203 002 | F-431 | Obermesser | 2285 x 39 x 7 |
| 070 90 657 | 455 2203 002 | F-4002 | Obermesser | 2285 x 39 x 7 |
| 070 90 667 | 45 070 90 667 | F-431 | Obermesser | 260 x 90 x 10 |
| 070 90 668 | 45 070 90 668 | F-431 | Obermesser | 260 x 90 x 10 |
| 070 90 669 | 45 070 90 669 | F-431 | Obermesser | 260 x 90 x 10 |
| 070 90 681 | 455 1704 000 | F-431 | Obermesser | 1740 x 48 x 12/5 |
| 070 90 683 | 455 2706 000 | F-431 | Obermesser | 2775 x 60 x 9,5/6 |
| 070 90 697 | 45 070 90 697 | F-4002 | Messer | 115 x 22 x 5 |
| 070 90 777 | 45 070 90 777 | F-431 | Messer | 210 x 55 x 2 |
| 070 90 779 | 455 2205 005 | F-8000 | Obermesser | 2285 x 55 x 10 |
| 070 90 780 | 45 070 90 780 | F-431 | Messer | 208 x 60 x 2 |
| 070 90 835 | 45 070 90 835 | F-431 | Untermesser | 1220 x 40 x 10 |
| 070 90 836 | 45 070 90 836 | F-431 | Untermesser | 1220 x 40 x 6 |
| 070 90 845 | 45 070 90 845 | F-4002 | Untermesser | 1240 x 50 x 10 |
| 070 90 913 | 45 070 90 913 | F-431 | Untermesser | 160 x 40 x 10 |

BIELOMATIK

| Original Nr./No. | FASSCO Nr./No. | Qualität Qual./Calid. | | Abmessungen in mm Size/Dimension/Tamaño |
|------------------|-----------------|-----------------------|-------------|---|
| 070 90 914 | 45 070 90 914 | F-431 | Obermesser | 75 x 75/70 x 5 |
| 070 90 932 | 45 070 90 932 | F-431 | Messer | 195 x 50 x 4 |
| 070 90 958 | 45 070 90 958 | F-431 | Untermesser | 360 x 22 x 8 |
| 070 90 959 | 45 070 90 959 | F-431 | Messer | 35 x 25 x 12 |
| 070 90 960 | 45 070 90 960 | F-431 | Messer | 25 x 42,5/34,5 x 8 |
| 070 91 016 | 45 070 91 016 | F-431 | Obermesser | 192,5 x 120 x 15 |
| 070 91 016-1 | 45 070 91 016-1 | F-431 | Obermesser | 192,5 x 120 x 15 |
| 070 91 016-2 | 45 070 91 016-2 | F-431 | Obermesser | 192,5 x 120 x 15 |
| 070 91 020 | 45 070 91 020 | F-431 | Obermesser | 260 x 90 x 8 |
| 070 91 021 | 45 070 91 021 | F-431 | Obermesser | 260 x 90 x 10/8 |
| 070 91 022 | 45 070 90 022 | F-431 | Obermesser | 260 x 90 x 10/8 |
| 070 91 025 | 455 1704 102 | F-431 | Untermesser | 1735 x 41 x 9/6 |
| 070 91 026 | 455 1704 003 | F-431 | Obermesser | 1735 x 40 x 10/8 |
| 070 91 041 | 45 070 91 041 | F-431 | Obermesser | 420 x 105 x 15 |
| 070 91 092 | 45 070 91 092 | F-431 | Untermesser | 360 x 35 x 15 |
| 070 91 185 | 45 070 91 185 | F-431 | Obermesser | 260 x 90 x 10 |

Andere KUGLER-WOMAKO-Typen und Qualitäten auf Anfrage
Other KUGLER-WOMAKO types and qualities upon request

WILL (WOMAKO) (KÖRBER PAPERLINK)

| Original Nr./No. | FASSCO Nr./No. | Qualität Qual./Calid. | | Abmessungen in mm Size/Dimension/Tamaño |
|------------------|----------------|-----------------------|-------------|---|
| 000-8400-007 | 0452.0810.000 | F-431 | Obermesser | 800 x 100 x 14,8 |
| 000-8400-007 | 0452.0810.000 | F-3000 | Obermesser | 800 x 100 x 14,8 |
| 000-8400-009 | 0452.1010.000 | F-431 | Obermesser | 1000 x 100 x 14,8 |
| 000-8400-009 | 0452.1010.000 | F-3000 | Obermesser | 1000 x 100 x 14,8 |
| 000-8400-011 | 0452.1210.000 | F-431 | Obermesser | 1250 x 100 x 14,8 |
| 000-8400-011 | 0452.1210.000 | F-3000 | Obermesser | 1250 x 100 x 14,8 |
| 000-8400-011 | 0452.1210.000 | F-8000 | Obermesser | 1250 x 100 x 14,8 |
| 000-8400-013 | 0452.1410.000 | F-431 | Obermesser | 1410 x 100 x 14,8 |
| 000-8400-013 | 0452.1410.000 | F-3000 | Obermesser | 1410 x 100 x 14,8 |
| 000-8400-067 | 0452.0810.000 | F-8000 | Obermesser | 800 x 100 x 14,8 |
| 000-8400-069 | 0452.1010.000 | F-8000 | Obermesser | 1000 x 100 x 14,8 |
| 000-8400-073 | 0452.1410.000 | F-8000 | Obermesser | 1410 x 100 x 14,8 |
| 000-8400-107 | 0452.0708.102 | F-431 | Untermesser | 750 x 80 x 12 |
| 000-8400-108 | 0452.0707.100 | F-431 | Untermesser | 750 x 70 x 12 |

WILL (WOMAKO) (KÖRBER PAPERLINK)

| Original Nr./No. | FASSCO Nr./No. | Qualität Qual./Calid. | | Abmessungen in mm Size/Dimension/Tamaño |
|-------------------|----------------|-----------------------|-------------|---|
| 000-8400-109 | 0452.0908.100 | F-431 | Untermesser | 950 x 80 x 12 |
| 000-8400-111 | 0452.1208.100 | F-431 | Untermesser | 1200 x 80 x 12 |
| 000-8400-113 | 0452.1408.100 | F-431 | Untermesser | 1400 x 80 x 12 |
| 000-8400-121 | 0452.1207.100 | F-431 | Untermesser | 1200 x 70 x 12 |
| 000-8400-137 | 0452.0708.102 | F-4002 | Untermesser | 750 x 80 x 12 |
| 000-8400-139 | 0452.0908.100 | F-4002 | Untermesser | 950 x 80 x 12 |
| 000-8400-141 | 0452.1208.100 | F-4002 | Untermesser | 1200 x 80 x 12 |
| 000-8400-143 | 0452.1408.100 | F-4002 | Untermesser | 1400 x 80 x 12 |
| 000-8400-167 | 0452.0708.102 | F-8000 | Untermesser | 750 x 80 x 12 |
| 000-8400-169 | 0452.0908.100 | F-8000 | Untermesser | 950 x 80 x 12 |
| 000-8400-171 | 0452.1208.100 | F-8000 | Untermesser | 1200 x 80 x 12 |
| 000-8400-173 | 0452.1408.100 | F-8000 | Untermesser | 1400 x 80 x 12 |
| 000-8400-203 | 0452.0211.000 | F-431 | Obermesser | 295 x 110 x 12 |
| 000-8400-203 | 0452.0211.000 | F-3000 | Obermesser | 295 x 110 x 12 |
| 000-8400-208 | 0452.0311.001 | F-431 | Obermesser | 385 x 110 x 12 |
| 000-8400-208 | 0452.0311.001 | F-3000 | Obermesser | 385 x 110 x 12 |
| 000-8400-263 | 0452.0211.000 | F-8000 | Obermesser | 295 x 110 x 12 |
| 000-8400-268 | 0452.0311.001 | F-8000 | Obermesser | 385 x 110 x 12 |
| 000-8400-506 | 0452.1205.001 | F-431 | Obermesser | 1250 x 58 x 5 |
| 000-8400-507 | 0452.0705.000 | F-431 | Obermesser | 750 x 58 x 5 |
| 000-8400-508 | 0452.1005.001 | F-431 | Obermesser | 1000 x 58 x 5 |
| 000-8400-511 | 0452.1205.000 | F-431 | Obermesser | 1200 x 58 x 5 |
| 000-8400-607 | 0452.0705.100 | F-431 | Untermesser | 750 x 50 x 10 |
| 000-8400-721 | 0452.2204.001 | F-4002 | Obermesser | 2200 x 40,1 x 8/5 |
| 000-8400-751 | 0452.2204.000 | F-431 | Obermesser | 2200 x 40 x 7,9/5 |
| 000-8400-851 | 0452.2203.100 | F-431 | Untermesser | 2200 x 30 x 8 |
| 000-8400-906 | 0452.1203.102 | F-431 | Untermesser | 1250 x 30 x 10 |
| 000-8400-907 | 0452.0703.100 | F-431 | Untermesser | 750 x 30 x 10 |
| 000-8400-908 | 0452.1003.101 | F-431 | Untermesser | 1000 x 30 x 10 |
| 000-8400-911 | 0452.1103.100 | F-431 | Untermesser | 1150 x 30 x 10 |
| 000-8400-912 | 0452.1203.100 | F-431 | Untermesser | 1200 x 30 x 10 |
| 000-8400-913 | 0452.1303.100 | F-431 | Untermesser | 1350 x 30 x 10 |
| 000-8400-915 | 0452.1603.100 | F-431 | Untermesser | 1600 x 30 x 10 |
| 000-8400-916 | 0452.1503.100 | F-431 | Untermesser | 1500 x 30 x 10 |
| 000-8400-917 | 0452.1703.100 | F-431 | Untermesser | 1700 x 30 x 10 |
| 000-8400-941 | 0452.1103.100 | F-4002 | Untermesser | 1150 x 30 x 10 |
| 000-8400-943 | 0452.1303.100 | F-4002 | Untermesser | 1350 x 30 x 10 |
| 000-8403-017 | 0452.1211.000 | F-431 | Obermesser | 1250 x 110 x 9,8 |
| 000-8403-017 | 0452.1211.000 | F-3000 | Obermesser | 1250 x 110 x 9,8 |
| 210-78.02-10/0 | 0452.1208.000 | F-431 | Obermesser | 1210 x 80 x 10 |
| 210-78.02-10/0 | 0452.1208.000 | F-3000 | Obermesser | 1210 x 80 x 10 |
| 211-27.02-10/0 | 0452.0306.100 | F-431 | Untermesser | 320 x 60 x 10 |
| 211-27.02-11/2 | 0452.0306.000 | F-431 | Obermesser | 300 x 62 x 10 |
| 211-27.02-11/6 | 0452.0306.002 | F-431 | Obermesser | 300 x 62 x 10 |
| 211-36.09-12/0 | 0452.0405.101 | F-431 | Untermesser | 420 x 50 x 10 |
| 212-06.02-05/2 60 | 0452.0605.001 | F-431 | Obermesser | 650 x 58 x 5 |
| 212-06.02-05/2 70 | 0452.0705.000 | F-431 | Obermesser | 750 x 58 x 5 |

WILL (WOMAKO) (KÖRBER PAPERLINK)

| Original Nr./No. | FASSCO Nr./No. | Qualität Qual./Calid. | | Abmessungen in mm Size/Dimension/Tamaño |
|--------------------|----------------|-----------------------|-------------|---|
| 212-06.02-05/2 80 | 0452.0805.000 | F-431 | Obermesser | 850 x 58 x 5 |
| 212-06.02-05/2 90 | 0452.0905.000 | F-431 | Obermesser | 950 x 58 x 5 |
| 212-06.02-05/2 100 | 0452.1005.000 | F-431 | Obermesser | 1050 x 58 x 5 |
| 212-06.02-05/2 110 | 0452.1105.000 | F-431 | Obermesser | 1150 x 58 x 5 |
| 212-06.02-05/2 140 | 0452.1405.000 | F-431 | Obermesser | 1450 x 58 x 5 |
| 212-06.02-06/2 60 | 0452.0605.100 | F-431 | Untermesser | 650 x 50 x 10 |
| 212-06.02-06/2 70 | 0452.0705.100 | F-431 | Untermesser | 750 x 50 x 10 |
| 212-06.02-06/2 80 | 0452.0805.100 | F-431 | Untermesser | 850 x 50 x 10 |
| 212-06.02-06/2 90 | 0452.0905.100 | F-431 | Untermesser | 950 x 50 x 10 |
| 212-06.02-06/2 100 | 0452.1005.100 | F-431 | Untermesser | 1050 x 50 x 10 |
| 212-06.02-06/2 110 | 0452.1105.100 | F-431 | Untermesser | 1150 x 50 x 10 |
| 212-06.02-06/2 140 | 0452.1405.101 | F-431 | Untermesser | 1450 x 50 x 10 |
| 212-36.02-08/0 | 0452.1010.100 | F-431 | Untermesser | 1020 x 100 x 10 |
| 212-36.02-09/0 | 0452.1008.000 | F-431 | Obermesser | 1080 x 80 x 10 |
| 212-36.02-09/0 | 0452.1008.000 | F-3000 | Obermesser | 1080 x 80 x 10 |
| 213-36.02-08/0 | 0452.1010.101 | F-431 | Untermesser | 1050 x 100 x 12 |
| 213-36.02-08/1 | 0452.1010.102 | F-431 | Untermesser | 1050 x 100 x 12 |
| 213-36.02-09/0 | 0452.1108.000 | F-431 | Obermesser | 1110 x 80 x 10 |
| 213-36.02-09/0 | 0452.1108.000 | F-3000 | Obermesser | 1110 x 80 x 10 |
| 215-34.05-49/0 | 0452.0306.003 | F-431 | Obermesser | 300 x 68 x 10 |
| 215-34.05-49/0 | 0452.0306.003 | F-3000 | Obermesser | 300 x 68 x 10 |
| 215-36.02-20/0 | 0452.1408.000 | F-431 | Obermesser | 1405 x 80 x 10 |
| 215-36.02-20/0 | 0452.1408.000 | F-3000 | Obermesser | 1405 x 80 x 10 |
| 220-02.01-06/0 | 0452.0506.000 | F-431 | Obermesser | 500 x 62 x 10 |
| 220-02.01-07/0 | 0452.0506.100 | F-431 | Untermesser | 520 x 60 x 10 |
| 220-18.24-04/0 | 0452.1305.700 | F-431 | Obermesser | 1350 x 58 x 5 |
| 222-32.10-04/0 | 0452.0509.000 | F-431 | Obermesser | 534 x 95 x 10 |
| 222-32.10-04/0 | 0452.0509.000 | F-3000 | Obermesser | 534 x 95 x 10 |
| 222-32.10-05/0 | 0452.0506.101 | F-431 | Untermesser | 550 x 60 x 10 |
| 222-34.04-08/0 | 0452.0307.002 | F-431 | Obermesser | 300 x 75 x 10 |
| 222-34.04-08/0 | 0452.0307.002 | F-3000 | Obermesser | 300 x 75 x 10 |
| 222-36.02-10/0 | 0452.0709.000 | F-431 | Obermesser | 738 x 90 x 10 |
| 222-36.02-10/0 | 0452.0709.000 | F-3000 | Obermesser | 738 x 90 x 10 |
| 222-36.02-11/0 | 0452.0610.100 | F-431 | Untermesser | 650 x 105 x 10 |
| 223-34.04-11/0 | 0452.0506.102 | F-431 | Untermesser | 500 x 60 x 10 |
| 224-34.04-15/0 | 0452.0309.001 | F-431 | Obermesser | 380 x 95 x 10 |
| 224-34.04-15/0 | 0452.0309.001 | F-3000 | Obermesser | 380 x 95 x 10 |
| 224-34.05-04/0 | 0452.0309.002 | F-431 | Obermesser | 380 x 95 x 10 |
| 224-34.05-04/0 | 0452.0309.002 | F-3000 | Obermesser | 380 x 95 x 10 |
| 224-36.02-09/0 | 0452.0807.000 | F-431 | Obermesser | 810 x 75 x 10 |
| 224-36.02-09/0 | 0452.0807.000 | F-3000 | Obermesser | 810 x 75 x 10 |
| 225-34.04-03/2 | 0452.0310.000 | F-431 | Obermesser | 390 x 100 x 12 |
| 225-34.05-03/0 | 0452.0309.000 | F-431 | Obermesser | 385 x 95 x 10 |
| 225-34.05-03/0 | 0452.0309.000 | F-3000 | Obermesser | 385 x 95 x 10 |
| 230-34.04-04/0 | 0452.0204.100 | F-431 | Untermesser | 280 x 40 x 32 |
| 230-35.06-04/0 | 0452.0202.100 | F-431 | Untermesser | 277 x 25 x 15 |
| 230-35.72-04/0 | 0452.0208.002 | F-431 | Obermesser | 295 x 80 x 10 |

WILL (WOMAKO) (KÖRBER PAPERLINK)

| Original Nr./No. | FASSCO Nr./No. | Qualität Qual./Calid. | | Abmessungen in mm Size/Dimension/Tamaño |
|------------------|----------------|-----------------------|-------------|---|
| 230-35.72-04/0 | 0452.0208.002 | F-3000 | Obermesser | 295 x 80 x 10 |
| 230-37.13-04/0 | 0452.0202.101 | F-431 | Untermesser | 297 x 24 x 15 |
| 230-37.13-07/0 | 0452.0202.102 | F-431 | Untermesser | 297 x 25 x 15 |
| 232-06.45-92/0 | 0452.0705.001 | F-431 | Obermesser | 750 x 50 x 8 |
| 232-34.52-04/0 | 0452.0710.001 | F-431 | Obermesser | 765 x 100 x 14,8 |
| 232-34.52-04/0 | 0452.0710.001 | F-3000 | Obermesser | 765 x 100 x 14,8 |
| 232-35.73-90/0 | 0452.0710.002 | F-431 | Obermesser | 765 x 100 x 9,8 |
| 232-35.73-90/0 | 0452.0710.002 | F-3000 | Obermesser | 765 x 100 x 9,8 |
| 234-06.27-09/0 | 0452.1203.100 | F-431 | Untermesser | 1200 x 30 x 10 |
| 280-34.06-02/0 | 0452.0208.000 | F-431 | Obermesser | 295 x 80 x 10 |
| 280-34.06-02/0 | 0452.0208.000 | F-3000 | Obermesser | 295 x 80 x 10 |
| 280-34.27-02/0 | 0452.0308.002 | F-431 | Obermesser | 385 x 80 x 10 |
| 280-34.27-02/0 | 0452.0308.002 | F-3000 | Obermesser | 385 x 80 x 10 |
| 280-34.27-02/0 | 0452.0308.002 | F-8000 | Obermesser | 385 x 80 x 10 |
| 280-34.36-01/0 | 0452.0303.100 | F-431 | Untermesser | 385 x 35 x 12 |
| 280-34.38-02/0 | 0452.0203.100 | F-431 | Untermesser | 260 x 35 x 12 |
| 280-34.38-02/1 | 0452.0203.101 | F-431 | Untermesser | 270 x 35 x 12 |
| 280-34.39-02/0 | 0452.0303.101 | F-431 | Untermesser | 350 x 35 x 12 |
| 280-95.27-04/0 | 0452.0108.000 | F-431 | Obermesser | 115 x 80 x 10 |
| 284-06.06-04/0 | 0452.1105.900 | F-431 | Messer | 1140 x 80 x 8 |
| 284-34.02-04/0 | 0452.1110.000 | F-431 | Obermesser | 1165 x 100 x 14,8 |
| 284-34.02-04/0 | 0452.1110.000 | F-3000 | Obermesser | 1165 x 100 x 14,8 |
| 284-34.02-05/0 | 0452.1108.100 | F-431 | Untermesser | 1140 x 80 x 12 |
| 285-34.02-04/0 | 0452.1310.000 | F-431 | Obermesser | 1386 x 100 x 14,8 |
| 285-34.02-04/0 | 0452.1310.000 | F-3000 | Obermesser | 1386 x 100 x 14,8 |
| 285-34.02-05/0 | 0452.1308.100 | F-431 | Untermesser | 1360 x 80 x 12 |
| 290-06.06-11/0 | 0452.0705.900 | F-431 | Messer | 720 x 50 x 8 |
| 290-06.46-06/0 | 0452.0705.700 | F-431 | Messer | 719 x 50 x 8 |
| 290-06.46-07/0 | 0452.0705.701 | F-431 | Messer | 720 x 50 x 8 |
| 290-06.46-08/0 | 0452.0705.702 | F-431 | Messer | 719 x 50 x 8 |
| 290-06.46-09/0 | 0452.0705.703 | F-431 | Messer | 719 x 50 x 8 |
| 441-20.01-10/0 | 0452.1904.000 | F-431 | Obermesser | 1990 x 40 x 7,9/5 |
| 442-20.01-10/0 | 0452.1504.001 | F-431 | Obermesser | 1590 x 40 x 7,9/5 |
| 444-20.01-10/0 | 0452.1104.001 | F-431 | Obermesser | 1190 x 40 x 7,9/5 |
| 445-20.01-10/0 | 0452.1304.001 | F-431 | Obermesser | 1340 x 40 x 7,9/5 |
| 446-20.01-10/0 | 0452.1704.001 | F-431 | Obermesser | 1790 x 40 x 7,9/5 |
| 447-20.01-10/0 | 0452.1904.001 | F-431 | Obermesser | 1940 x 40 x 7,9/5 |
| 448-20.01-10/0 | 0452.2104.001 | F-431 | Obermesser | 2140 x 40 x 7,9/5 |
| 449-20.01-10/0 | 0452.2204.001 | F-431 | Obermesser | 2220 x 40 x 7,9/5 |
| 441-20.01-11/1 | 0452.1903.100 | F-431 | Untermesser | 1990 x 30 x 8/6 |
| 442-20.01-11/1 | 0452.1503.101 | F-431 | Untermesser | 1590 x 30 x 8/6 |
| 444-20.01-11/1 | 0452.1103.101 | F-431 | Untermesser | 1190 x 30 x 8/6 |
| 445-20.01-11/1 | 0452.1303.101 | F-431 | Untermesser | 1340 x 30 x 8/6 |
| 446-20.01-11/1 | 0452.1703.101 | F-431 | Untermesser | 1790 x 30 x 8/6 |
| 447-20.01-11/1 | 0452.1903.101 | F-431 | Untermesser | 1940 x 30 x 8/6 |
| 448-20.01-11/1 | 0452.2103.101 | F-431 | Untermesser | 2140 x 30 x 8/6 |
| 449-20.01-11/1 | 0452.2203.101 | F-431 | Untermesser | 2200 x 30 x 8/6 |

WILL (WOMAKO) (KÖRBER PAPERLINK)

| Original Nr./No. | FASSCO Nr./No. | Qualität Qual./Calid. | | Abmessungen in mm Size/Dimension/Tamaño |
|------------------|----------------|-----------------------|-------------|---|
| 471-25.02-70/1 | 0452.1903.900 | F-431 | Messer | 1990 x 33,1 x 8 |
| 471-25.02-70/1 | 0452.1903.900 | F-4002 | Messer | 1990 x 33,1 x 8 |
| 474-25.02-70/1 | 0452.2403.900 | F-431 | Messer | 2440 x 33,1 x 8 |
| 474-25.02-70/1 | 0452.2403.900 | F-4002 | Messer | 2440 x 33,1 x 8 |
| 475-25.02-70/1 | 0452.1303.900 | F-431 | Messer | 1390 x 33,1 x 8 |
| 475-25.02-70/1 | 0452.1303.900 | F-4002 | Messer | 1390 x 33,1 x 8 |
| 476-25.02-70/1 | 0452.1703.900 | F-431 | Messer | 1790 x 33,1 x 8 |
| 476-25.02-70/1 | 0452.1703.900 | F-4002 | Messer | 1790 x 33,1 x 8 |
| 477-25.02-70/1 | 0452.2603.900 | F-431 | Messer | 2640 x 33,1 x 8 |
| 477-25.02-70/1 | 0452.2603.900 | F-4002 | Messer | 2640 x 33,1 x 8 |
| 478-25.02-70/1 | 0452.2803.900 | F-431 | Messer | 2840 x 33,1 x 8 |
| 478-25.02-70/1 | 0452.2803.900 | F-4002 | Messer | 2840 x 33,1 x 8 |
| 479-25.02-70/1 | 0452.2203.900 | F-431 | Messer | 2200 x 33,1 x 8 |
| 479-25.02-70/1 | 0452.2203.900 | F-4002 | Messer | 2200 x 33,1 x 8 |
| 482-06.03-06/0 | 0452.1603.000 | F-431 | Obermesser | 1600 x 38 x 5 |
| 482-06.03-07/0 | 0452.1605.101 | F-431 | Untermesser | 1600 x 50 x 10 |
| 485-06.03-06/0 | 0452.1403.000 | F-431 | Obermesser | 1400 x 38 x 5 |
| 485-06.03-07/0 | 0452.1405.100 | F-431 | Untermesser | 1400 x 50 x 10 |
| 485-20.05-07/0 | 0452.1304.002 | F-431 | Obermesser | 1390 x 40 x 7,9/5 |
| 485-20.05-08/0 | 0452.1303.102 | F-431 | Untermesser | 1390 x 30 x 8 |
| 486-06.03-06/0 | 0452.1804.000 | F-431 | Obermesser | 1800 x 40 x 5 |
| 486-06.03-06/0 | 0452.1804.000 | F-4002 | Obermesser | 1800 x 40 x 5 |
| 486-06.03-06/0 | 0452.1804.000 | F-8000 | Obermesser | 1800 x 40 x 5 |
| 486-06.03-07/0 | 0452.1805.101 | F-431 | Untermesser | 1800 x 50 x 10 |
| 486-06.03-07/0 | 0452.1805.101 | F-4002 | Untermesser | 1800 x 50 x 10 |
| 486-06.03-07/0 | 0452.1805.101 | F-8000 | Untermesser | 1800 x 50 x 10 |
| 491-94.01-01/2 | 0452.1903.104 | F-4002 | Untermesser | 1990 x 33 x 6 |
| 491-94.01-01/3 | 0452.1903.003 | F-4002 | Obermesser | 1990 x 33 x 6 |
| 494-94.01-01/2 | 0452.2403.102 | F-4002 | Untermesser | 2440 x 33 x 6 |
| 494-94.01-01/3 | 0452.2403.002 | F-4002 | Obermesser | 2440 x 33 x 6 |
| 495-94.01-01/2 | 0452.1303.105 | F-4002 | Untermesser | 1390 x 33 x 6 |
| 495-94.01-01/3 | 0452.1303.002 | F-4002 | Obermesser | 1390 x 33 x 6 |
| 496-94.01-01/2 | 0452.1703.104 | F-4002 | Untermesser | 1790 x 33 x 6 |
| 496-94.01-01/3 | 0452.1703.001 | F-4002 | Obermesser | 1790 x 33 x 6 |
| 498-94.01-01/2 | 0452.2803.101 | F-4002 | Untermesser | 2860 x 33 x 6 |
| 498-94.01-01/3 | 0452.2803.001 | F-4002 | Obermesser | 2860 x 33 x 6 |
| 499-94.01-01/2 | 0452.2203.102 | F-4002 | Untermesser | 2200 x 33 x 6 |
| 499-94.01-01/3 | 0452.2203.001 | F-4002 | Obermesser | 2200 x 33 x 6 |
| 502-08.08-04/4 | 0452.0608.001 | F-431 | Obermesser | 635 x 88 x 8 |
| 502-08.08-04/4 | 0452.0608.001 | F-3000 | Obermesser | 635 x 88 x 8 |
| 502-08.08-05/0 | 0452.0604.101 | F-431 | Untermesser | 650 x 40 x 10 |
| 502-08.08-06/0 | 0452.0204.101 | F-431 | Untermesser | 270 x 40 x 10 |
| 502-08.08-07/1 | 0452.0207.000 | F-431 | Obermesser | 245 x 72 x 8 |
| 502-08.08-07/1 | 0452.0207.000 | F-3000 | Obermesser | 245 x 72 x 8 |
| 502-08.08-07/4 | 0452.0209.700 | F-431 | Obermesser | 245 x 90/65 x 8 |
| 502-08.08-08/1 | 0452.0207.001 | F-431 | Obermesser | 245 x 72 x 8 |
| 502-08.08-08/1 | 0452.0207.001 | F-3000 | Obermesser | 245 x 72 x 8 |

WILL (WOMAKO) (KÖRBER PAPERLINK)

| Original Nr./No. | FASSCO Nr./No. | Qualität Qual./Calid. | | Abmessungen in mm Size/Dimension/Tamaño |
|------------------|----------------|-----------------------|-----------------|---|
| 502-08.08-07/3 | 0452.0208.004 | F-431 | Obermesser | 245 x 84/72 x 8 |
| 502-08.08-07/4 | 0452.0208.005 | F-431 | Obermesser | 245 x 84/72 x 8 |
| 510-34.04-07/1 | 0452.0208.001 | F-431 | Obermesser | 260 x 80 x 10 |
| 510-34.04-07/1 | 0452.0208.001 | F-3000 | Obermesser | 260 x 80 x 10 |
| 511-36.02-08/0 | 0452.0710.100 | F-431 | Untermesser | 750 x 100 x 12 |
| 511-36.02-09/0 | 0452.0808.000 | F-431 | Obermesser | 810 x 80 x 10 |
| 511-36.02-09/0 | 0452.0808.000 | F-3000 | Obermesser | 810 x 80 x 10 |
| 514-05.27-03/0 | 0452.1108.101 | F-431 | Untermesser | 1160 x 80 x 12 |
| 520-34.26-03/0 | 0452.0302.100 | F-431 | Untermesser | 350 x 20 x 12 |
| 520-34.54-05/0 | 0452.0308.100 | F-431 | Untermesser | 360 x 80 x 12 |
| 520-80.02-23/0 | 0452.0708.101 | F-431 | Untermesser | 700 x 80 x 12 |
| 521-34.05-01/0 | 0452.0308.005 | F-431 | Obermesser | 395 x 85 x 12 |
| 521-34.05-02/0 | 0452.0306.101 | F-431 | Untermesser | 360 x 60 x 9,9 |
| 521-80.09-02/0 | 0452.0508.000 | F-431 | Obermesser | 500 x 80 x 10 |
| 525-34.15-28/0 | 0452.0302.102 | F-431 | Untermesser | 360 x 20 x 15 |
| 525-80.13-40/0 | 0452.0709.000 | F-431 | Obermesser | 775 x 90 x 15 |
| 530-34.02-01/0 | 0452.0308.001 | F-431 | Obermesser | 385 x 80 x 10 |
| 530-34.02-01/0 | 0452.0308.001 | F-3000 | Obermesser | 385 x 80 x 10 |
| 530-78.24-23/0 | 0452.0003.700 | F-431 | Platte | 25 x 32 x 2,55 |
| 530-80.03-14/0 | 0452.0304.101 | F-431 | Untermesser | 350 x 40 x 10 |
| 532-78.24-01/0 | 0452.0003.703 | F-431 | Messer | 40,4 x 35 x 2,5 |
| 534-34.07-04/0 | 0452.0408.006 | F-431 | Obermesser | 485 x 80 x 10 |
| 534-34.07-04/0 | 0452.0408.006 | F-3000 | Obermesser | 485 x 80 x 10 |
| 534-44.05-01/0 | 0452.0308.009 | F-431 | Obermesser | 395 x 80 x 12 |
| 534-44.05-02/0 | 0452.0306.104 | F-431 | Untermesser | 360 x 60,34 x 9,8 |
| 536-11.20-10/0 | 0452.0605.000 | F-431 | Obermesser | 620 x 50 x 10 |
| 536-11.20-12/0 | 0452.0604.100 | F-431 | Untermesser | 620 x 40 x 10 |
| 536-26.14-13/0 | 0452.0003.701 | F-431 | Platte | 38 x 32 x 4 |
| 536-26.14-14/0 | 0452.0003.702 | F-431 | Gegenmesser | 38 x 35 x 4 |
| 542-34.03-18/0 | 0452.0306.103 | F-431 | Untermesser | 390 x 60 x 12 |
| 556-08.08-39/0 | 0452.0708.000 | F-431 | Obermesser | 740 x 87/72 x 10 |
| 556-08.08-39/0 | 0452.0708.000 | F-3000 | Obermesser | 740 x 87/72 x 10 |
| 556-08.08-40/0 | 0452.0604.102 | F-431 | Untermesser | 650 x 40 x 12 |
| 556-08.08-41/0 | 0452.0304.102 | F-431 | Untermesser | 340 x 40 x 12 |
| 556-08.08-42/0 | 0452.0312.000 | F-3000 | Obermesser, re. | 374 x 125/85 x 10 |
| 556-08.08-42/1 | 0452.0311.700 | F-431 | Trennmesser | 374 x 110/85 x 10 |
| 556-08.08-42/1 | 0452.0311.700 | F-3000 | Trennmesser | 374 x 110/85 x 10 |
| 556-08.08-43/0 | 0452.0312.001 | F-3000 | Obermesser, li. | 374 x 125/85 x 10 |
| 561-20.06-04/0 | 0452.0404.100 | F-431 | Untermesser | 450 x 45 x 10 |
| 561-20.06-05/0 | 0452.0404.000 | F-431 | Obermesser | 450 x 48 x 5 |
| 613-06.05-21/0 | 0452.1508.100 | F-431 | Untermesser | 1550 x 80 x 15 |
| 613-06.05-22/0 | 0452.1505.000 | F-431 | Obermesser | 1550 x 58 x 5 |
| 651-06.06-04/0 | 0452.0505.900 | F-431 | Messer | 540 x 50 x 8 |
| 653-16.06-07/1 | 0452.1004.900 | F-4002 | Messer | 1060 x 40 x 6 |
| 656-06.06-08/0 | 0452.0604.000 | F-431 | Obermesser | 688 x 40 x 6 |
| 715-38.10-08/0 | 0452.0409.000 | F-431 | Obermesser | 400 x 90 x 10 |
| 715-38.10-08/0 | 0452.0409.000 | F-3000 | Obermesser | 400 x 90 x 10 |

WILL (WOMAKO) (KÖRBER PAPERLINK)

| Original Nr./No. | FASSCO Nr./No. | Qualität Qual./Calid. | | Abmessungen in mm Size/Dimension/Tamaño |
|--------------------|----------------|-----------------------|--------------|---|
| 727-34.11-10/0 | 0452.0306.102 | F-3000 | Untermesser | 324 x 60 x 10 |
| 717-06.01-05/0 50 | 0452.0504.000 | F-431 | Obermesser | 550 x 40 x 5 |
| 717-06.01-05/0 70 | 0452.0704.000 | F-431 | Obermesser | 750 x 40 x 5 |
| 717-06.01-05/0 80 | 0452.0804.000 | F-431 | Obermesser | 850 x 40 x 5 |
| 717-06.01-05/0 90 | 0452.0904.000 | F-431 | Obermesser | 950 x 40 x 5 |
| 717-06.01-05/0 100 | 0452.1004.000 | F-431 | Obermesser | 1050 x 40 x 5 |
| 717-06.01-05/0 110 | 0452.1104.002 | F-431 | Obermesser | 1150 x 40 x 5 |
| 717-06.01-05/0 115 | 0452.1204.000 | F-431 | Obermesser | 1200 x 40 x 5 |
| 717-06.01-05/0 125 | 0452.1304.000 | F-431 | Obermesser | 1300 x 40 x 5 |
| 717-06.01-06/0 50 | 0452.0504.100 | F-431 | Untermesser | 550 x 40 x 10 |
| 717-06.01-06/0 70 | 0452.0704.100 | F-431 | Untermesser | 750 x 40 x 10 |
| 717-06.01-06/0 80 | 0452.0804.100 | F-431 | Untermesser | 850 x 40 x 10 |
| 717-06.01-06/0 90 | 0452.0904.100 | F-431 | Untermesser | 950 x 40 x 10 |
| 717-06.01-06/0 100 | 0452.1004.100 | F-431 | Untermesser | 1050 x 40 x 10 |
| 717-06.01-06/0 110 | 0452.1104.100 | F-431 | Untermesser | 1150 x 40 x 10 |
| 717-06.01-06/0 115 | 0452.1204.100 | F-431 | Untermesser | 1200 x 40 x 10 |
| 717-06.01-06/0 125 | 0452.1304.100 | F-431 | Untermesser | 1300 x 40 x 10 |
| 727-06.06-04/0 | 0452.0905.900 | F-431 | Messer | 940 x 50 x 8 |
| 727-34.11-10/0 | 0452.0306.102 | F-431 | Untermesser | 324 x 60 x 10 |
| 727-34.11-11/0 | 0452.0307.000 | F-431 | Obermesser | 366 x 70 x 10 |
| 727-34.11-11/0 | 0452.0307.000 | F-3000 | Obermesser | 366 x 70 x 10 |
| 727-36.06-17/0 | 0452.0905.002 | F-431 | Messer | 940 x 50 x 8 |
| 727-36.06-18/0 | 0452.0903.101 | F-431 | Untermesser | 940 x 30 x 10 |
| 727-95.03-27/0 | 0452.0905.101 | F-431 | Messer | 940 x 50 x 8 |
| 727-95.03-27/0 | 0452.0905.101 | F-4002 | Messer | 940 x 50 x 8 |
| 733-06.01-05/1 70 | 0452.0704.001 | F-431 | Obermesser | 740 x 40 x 5 |
| 733-06.01-05/1 80 | 0452.0804.001 | F-431 | Obermesser | 840 x 40 x 5 |
| 733-06.01-05/1 90 | 0452.0904.001 | F-431 | Obermesser | 940 x 40 x 5 |
| 733-06.01-05/1 100 | 0452.1004.001 | F-431 | Obermesser | 1040 x 40 x 5 |
| 733-06.01-05/1 110 | 0452.1104.003 | F-431 | Obermesser | 1140 x 40 x 5 |
| 733-06.01-05/1 115 | 0452.1104.004 | F-431 | Obermesser | 1190 x 40 x 5 |
| 733-06.01-05/1 125 | 0452.1204.001 | F-431 | Obermesser | 1290 x 40 x 5 |
| 733-06.01-05/1 140 | 0452.1404.000 | F-431 | Obermesser | 1440 x 40 x 5 |
| 733-06.01-05/1 155 | 0452.1504.002 | F-431 | Obermesser | 1590 x 40 x 5 |
| 733-06.01-06/0 70 | 0452.0704.700 | F-431 | Balkenmesser | 740 x 40 x 20 |
| 733-06.01-06/0 80 | 0452.0804.700 | F-431 | Balkenmesser | 840 x 40 x 20 |
| 733-06.01-06/0 90 | 0452.0904.700 | F-431 | Balkenmesser | 940 x 40 x 20 |
| 733-06.01-06/0 100 | 0452.1004.700 | F-431 | Balkenmesser | 1040 x 40 x 20 |
| 733-06.01-06/0 110 | 0452.1104.700 | F-431 | Balkenmesser | 1140 x 40 x 20 |
| 733-06.01-06/0 115 | 0452.1104.701 | F-431 | Balkenmesser | 1190 x 40 x 20 |
| 733-06.01-06/0 125 | 0452.1204.700 | F-431 | Balkenmesser | 1290 x 40 x 20 |
| 733-06.01-06/0 140 | 0452.1404.700 | F-431 | Balkenmesser | 1440 x 40 x 20 |
| 733-06.01-06/0 155 | 0452.1504.700 | F-431 | Balkenmesser | 1590 x 40 x 20 |
| 733-06.01-06/1 70 | 0452.0705.102 | F-431 | Untermesser | 740 x 50 x 10 |
| 733-06.01-06/1 80 | 0452.0805.102 | F-431 | Untermesser | 840 x 50 x 10 |
| 733-06.01-06/1 90 | 0452.0905.102 | F-431 | Untermesser | 940 x 50 x 10 |
| 733-06.01-06/1 100 | 0452.1005.102 | F-431 | Untermesser | 1040 x 50 x 10 |

WILL (WOMAKO) (KÖRBER PAPERLINK)

| Original Nr./No. | FASSCO Nr./No. | Qualität Qual./Calid. | | Abmessungen in mm Size/Dimension/Tamaño |
|--------------------|----------------|-----------------------|-------------|---|
| 733-06.01-06/1 110 | 0452.1105.103 | F-431 | Untermesser | 1140 x 50 x 10 |
| 733-06.01-06/1 115 | 0452.1105.104 | F-431 | Untermesser | 1190 x 50 x 10 |
| 733-06.01-06/1 125 | 0452.1205.101 | F-431 | Untermesser | 1290 x 50 x 10 |
| 733-06.01-06/1 140 | 0452.1405.103 | F-431 | Untermesser | 1440 x 50 x 10 |
| 733-06.01-06/1 155 | 0452.1505.100 | F-431 | Untermesser | 1590 x 50 x 10 |
| 750-34.04-10/0 | 0452.0307.001 | F-431 | Obermesser | 350 x 75 x 10 |
| 750-34.04-10/0 | 0452.0307.001 | F-3000 | Obermesser | 350 x 75 x 10 |
| 810-34.04-07/1 | 0452.0208.001 | F-431 | Obermesser | 260 x 80 x 10 |
| 810-80.01-02/0 | 0452.0911.000 | F-431 | Obermesser | 970 x 110 x 10 |
| 810-80.01-02/0 | 0452.0911.000 | F-3000 | Obermesser | 970 x 110 x 10 |
| 814-34.02-03/0 | 0452.1108.101 | F-431 | Untermesser | 1160 x 80 x 12 |
| 814-34.04-04/0 | 0452.1110.001 | F-431 | Obermesser | 1160 x 100 x 15 |
| 814-34.04-04/0 | 0452.1110.001 | F-3000 | Obermesser | 1160 x 100 x 15 |
| 830-34.04-10/0 | 0452.0311.000 | F-431 | Obermesser | 380 x 110 x 12 |
| 830-34.04-10/0 | 0452.0311.000 | F-3000 | Obermesser | 380 x 110 x 12 |
| 830-34.04-11/0 | 0452.0304.100 | F-431 | Untermesser | 360 x 40 x 10 |
| 832-36.02-10/0 | 0452.0810.001 | F-431 | Obermesser | 800 x 100 x 14,8 |
| 832-36.02-10/0 | 0452.0810.001 | F-3000 | Obermesser | 800 x 100 x 14,8 |
| 832-36.02-11/0 | 0452.0708.103 | F-431 | Untermesser | 750 x 80 x 12 |
| 834-36.02-10/0 | 0452.1210.001 | F-431 | Obermesser | 1250 x 100 x 14,8 |
| 834-36.02-10/0 | 0452.1210.001 | F-3000 | Obermesser | 1250 x 100 x 14,8 |
| 840-27.25-01/0 | 0452.0410.000 | F-431 | Obermesser | 490 x 100 x 14,8 |
| 840-27.25-01/0 | 0452.0410.000 | F-3000 | Obermesser | 490 x 100 x 14,8 |
| 840-27.25-02/0 | 0452.0405.100 | F-431 | Untermesser | 450 x 50 x 10 |
| 840-60.67-01/0 | 0452.0002.100 | F-431 | Untermesser | 60 x 24 x 4 |
| 840-60.67-03/0 | 0452.0005.000 | F-431 | Obermesser | 73/69 x 50/47,5 x 3 |
| 840-80.03-04/0 | 0452.0710.000 | F-431 | Obermesser | 750 x 100 x 14,8 |
| 840-80.03-04/0 | 0452.0710.000 | F-3000 | Obermesser | 750 x 100 x 14,8 |
| 840-80.03-05/0 | 0452.0708.100 | F-431 | Untermesser | 700 x 80 x 12 |
| 841-34.08-10/0 | 0452.0406.101 | F-431 | Untermesser | 400 x 60 x 9,8 |
| 841-34.08-15/0 | 0452.0408.007 | F-431 | Obermesser | 410 x 80 x 10 |
| 841-44.05-03/0 | 0452.0406.102 | F-431 | Untermesser | 490 x 60 x 9,8 |
| 841-44.05-11/0 | 0452.0508.001 | F-431 | Obermesser | 525 x 80 x 10 |
| 842-34.20-02/0 | 0452.0403.101 | F-431 | Untermesser | 450 x 35 x 35 |
| 842-34.20-02/1 | 0452.0403.100 | F-431 | Untermesser | 450 x 35 x 35 |
| 842-34.22-02/0 | 0452.0408.000 | F-431 | Obermesser | 400 x 80 x 10 |
| 842-34.22-02/0 | 0452.0408.000 | F-3000 | Obermesser | 400 x 80 x 10 |
| 842-34.22-04/0 | 0452.0408.001 | F-431 | Obermesser | 400 x 80 x 10 |
| 842-34.22-04/0 | 0452.0408.001 | F-3000 | Obermesser | 400 x 80 x 10 |
| 842-34.62-02/0 | 0452.0503.100 | F-431 | Untermesser | 520 x 35 x 35 |
| 842-34.66-04/0 | 0452.0408.002 | F-431 | Obermesser | 475 x 80 x 10 |
| 842-34.66-04/0 | 0452.0408.002 | F-3000 | Obermesser | 475 x 80 x 10 |
| 842-34.67-04/0 | 0452.0408.003 | F-431 | Obermesser | 475 x 80 x 10 |
| 842-34.67-04/0 | 0452.0408.003 | F-3000 | Obermesser | 475 x 80 x 10 |
| 842-34.68-02/0 | 0452.0408.004 | F-431 | Obermesser | 475 x 80 x 10 |
| 842-34.68-02/0 | 0452.0408.004 | F-3000 | Obermesser | 475 x 80 x 10 |
| 842-34.69-02/0 | 0452.0408.005 | F-431 | Obermesser | 475 x 80 x 10 |

WILL (WOMAKO) (KÖRBER PAPERLINK)

| Original Nr./No. | FASSCO Nr./No. | Qualität Qual./Calid. | | Abmessungen in mm Size/Dimension/Tamaño |
|------------------|----------------|-----------------------|-------------|---|
| 842-34.69-02/0 | 0452.0408.005 | F-3000 | Obermesser | 475 x 80 x 10 |
| 843-50.03-08/0 | 0452.0801.100 | F-431 | Leiste | 800 x 12 x 12 |
| 843-50.03-09/0 | 0452.0801.101 | F-431 | Leiste | 800 x 12 x 12 |
| 844-80.02-95/0 | 0452.1010.001 | F-431 | Obermesser | 1000 x 100 x 14,8 |
| 844-80.02-95/0 | 0452.1010.001 | F-3000 | Obermesser | 1000 x 100 x 14,8 |
| 844-80.02-23/0 | 0452.0908.101 | F-431 | Untermesser | 950 x 80 x 12 |
| 846-34.03-24/0 | 0452.0708.001 | F-431 | Obermesser | 750 x 80 x 12 |
| 846-34.24-04/0 | 0452.0308.003 | F-431 | Obermesser | 355 x 80 x 10 |
| 846-34.24-04/0 | 0452.0308.003 | F-3000 | Obermesser | 355 x 80 x 10 |
| AM 1M A50 070 | 0452.0705.100 | F-431 | Untermesser | 750 x 50 x 10 |
| AM 1M A50 080 | 0452.0805.100 | F-431 | Untermesser | 850 x 50 x 10 |
| AM 1M A50 090 | 0452.0905.100 | F-431 | Untermesser | 950 x 50 x 10 |
| AM 1M A50 100 | 0452.1005.100 | F-431 | Untermesser | 1050 x 50 x 10 |
| AM 1M A50 110 | 0452.1105.100 | F-431 | Untermesser | 1150 x 50 x 10 |
| AM 1M A50 115 | 0452.1205.100 | F-431 | Untermesser | 1200 x 50 x 10 |
| AM 1M A50 130 | 0452.1305.100 | F-431 | Untermesser | 1350 x 50 x 10 |
| AM 1M A50 140 | 0452.1405.101 | F-431 | Untermesser | 1450 x 50 x 10 |
| AM 1M A50 155 | 0452.1605.100 | F-431 | Untermesser | 1600 x 50 x 10 |
| AM 1M A50 170 | 0452.1705.100 | F-431 | Untermesser | 1750 x 50 x 10 |
| AM 1M A50 180 | 0452.1805.100 | F-431 | Untermesser | 1850 x 50 x 10 |
| AM 2M 558 070 | 0452.0705.000 | F-431 | Obermesser | 750 x 58 x 5 |
| AM 2M 558 080 | 0452.0805.000 | F-431 | Obermesser | 850 x 58 x 5 |
| AM 2M 558 090 | 0452.0905.000 | F-431 | Obermesser | 950 x 58 x 5 |
| AM 2M 558 100 | 0452.1005.000 | F-431 | Obermesser | 1050 x 58 x 5 |
| AM 2M 558 110 | 0452.1105.000 | F-431 | Obermesser | 1150 x 58 x 5 |
| AM 2M 558 115 | 0452.1205.000 | F-431 | Obermesser | 1200 x 58 x 5 |
| AM 2M 558 130 | 0452.1305.000 | F-431 | Obermesser | 1350 x 58 x 5 |
| AM 2M 558 140 | 0452.1405.000 | F-431 | Obermesser | 1450 x 58 x 5 |
| AM 2M 558 155 | 0452.1605.000 | F-431 | Obermesser | 1600 x 58 x 5 |
| AM 2M 558 170 | 0452.1705.000 | F-431 | Obermesser | 1750 x 58 x 5 |
| AM 2M 558 180 | 0452.1805.000 | F-431 | Obermesser | 1850 x 58 x 5 |

Andere Will-Womako-Typen und Qualitäten auf Anfrage
Other Will-Womako types and qualities upon request

QUERSCHNEIDEMESSER

SHEETER KNIVES



MESSER UND SCHNITTWERKZEUGE FÜR VERPACKUNGSMASCHINEN

KNIVES AND CUTTING TOOLS FOR PACKAGING EQUIPMENT



FASSCO SCHERENMESSER

für die Metallbearbeitung

FASSCO SHEAR BLADES

for metal-working

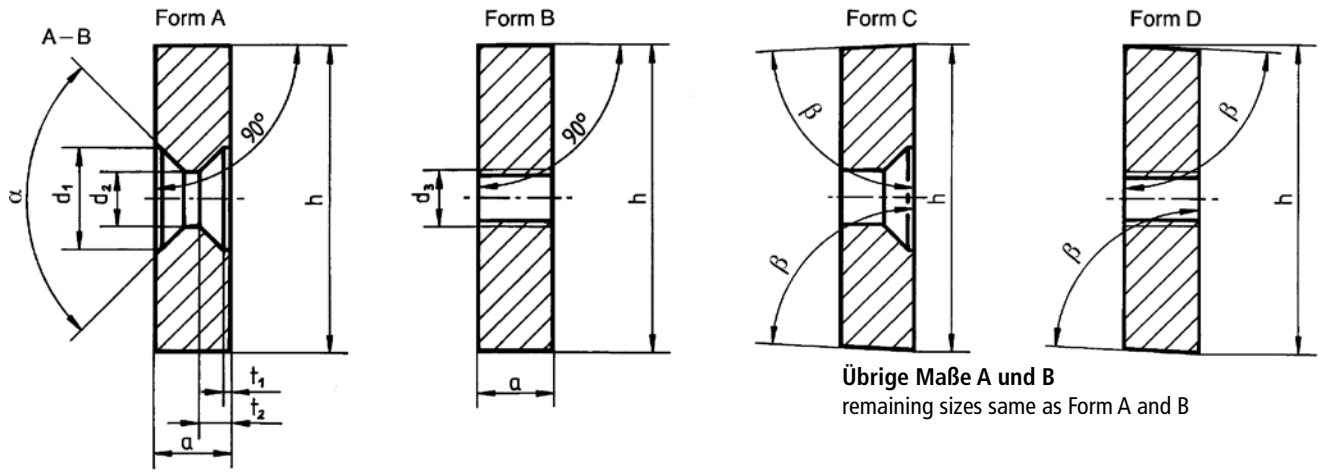
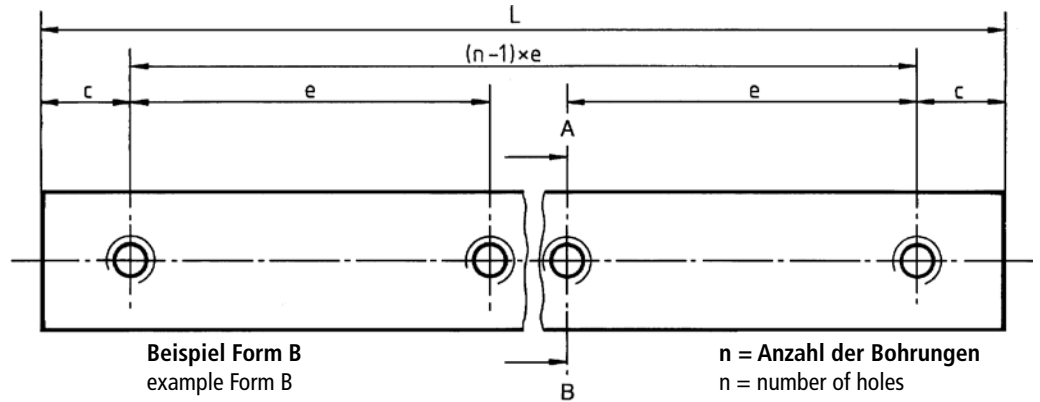

Erforderliche Angaben für Angebot und Fertigung
Required details for quotation and production

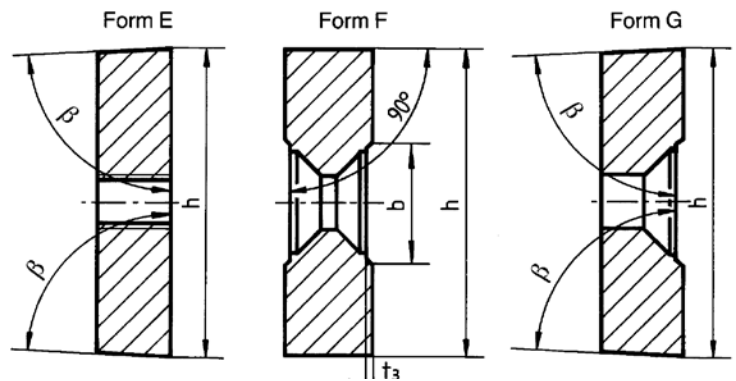

| | |
|--|--------------------|
| Zu schneidendes Material Material to be cut | |
| Güte quality | Dicke thickness |

| Form | L | h | a | n | d ₁ | d ₂ | α | d ₃ | t ₁ | t ₂ | t ₃ | b | c | e | β |
|------|---|---|---|---|----------------|----------------|---|----------------|----------------|----------------|----------------|---|---|---|---|
| | | | | | | | | | | | | | | | |

FASSCO SCHERENMESSER

für die Metallbearbeitung

FASSCO SHEAR BLADES

for metal-working



FASSCO KREISRUNDE MASCHINENMESSER

FASSCO CIRCULAR INDUSTRIAL KNIVES



Kreismesser

„Für alle Einsatzbereiche der Industrie“

Schwerpunkte

- Etikettier- und Kennzeichnungstechnik
- Klebstofftechnik
- Automation Verpackungstechniken
- Pharma- und Medizintechnik, Kosmetik
- Lebensmitteltechnik
- Umwelttechnik
- Papier, Karton, Pappe
- Holz-, Metall- Kunststoffverarbeitung

Geeignet zum Schneiden nahezu aller Materialien: Papier, Folien Textilien, Holz und Kunststoffe.

Wir, als die Messer-Spezialisten, empfehlen Ihnen den richtigen Werkstoff für Ihr Schnittgut.

Wir fertigen Messer aus Standard Werkzeugstahl, verschiedenen hochlegierten Chromstählen, HSS- Stählen, pulvermetallurgischen Stählen sowie aus rost- und säurebeständige Stählen oder Hartmetall.

Ihre Kreismesser produzieren wir nach Ihren Wünschen und Anforderungen, gem. Muster oder nach Zeichnung. Für ein bestmögliches Schneidergebnis für Ihr individuelles Produkt unterbreiten wir Ihnen auf Grundlage unserer langjährigen Erfahrung eine Empfehlung für die Schneidengeometrie als auch die passende Härte.

Kreismesser können mit Teflon oder anderen Beschichtungen für spezielle Anwendungen z. B. für die Lebensmittelindustrie veredelt werden!

Flache-, Hohle- und Teller-Kreismesser
(auch in geteilter Kreismesserausführung)

Standard Werkzeugstahlqualität: Fassco „F-520“ zum Beispiel aus: kreuzgewalzten Stahlblechen und Rundstähle hergestellt

Circular Knives

„For all industrial ideas“

Focus

- Labeling and marking equipment
- Adhesive technology
- Automation, packaging technology
- Pharmaceuticals and medical devices, cosmetics
- Food technology
- Environmental engineering
- Paper, carton, cardboard
- Wood, metal and plastics processing

Useful for cutting almost all materials: paper, foils, textiles, plastics, wood and steels.

We are knife specialists and cooperate with you to select the most effective steel material qualities.

For example: standard tool steel, chrome steels, HSS and ASP powder-metallurgical steel corrosion-resisting cutting steel or tungsten carbide.

We manufacture your circular knives according to your wishes and requirements, according to our recommendation based on set-up costs, for the best possible lifetime.

We also manufacture according to your drawings and samples!

Circular knives can be finished with Teflon or other topcoats for special applications!

For example: in the food industry!

Flat- Circular Knives, Hollow- Circular Knives and Special- Circular Knives
(also in split circular knife version)

Standard Tool Steel Quality: by Fassco „F220“ for example made of: cross-rolled steel sheets and round bar steel

Kaltarbeitsstahl

Bei Kaltarbeitsstahl handelt es sich um Werkzeugstahl, der im Allgemeinen im Einsatz für Oberflächentemperaturen bis 200 °C beständig ist. Die Stärke des Kaltarbeitsstahls ist eine hohe Härte, hohe Verschleißfestigkeit, gute Zähigkeit und gute Maßbeständigkeit bei noch ausreichender Bearbeitungsmöglichkeit.

Warmarbeitsstahl

Bei Warmarbeitsstahl handelt es sich um Werkzeugstahl, der im Einsatz für Dauertemperaturen von über 200°C geeignet ist. Im Einsatz kommt der Warmarbeitsstahl mit den heißen, zu verformenden Werkstoffen in Berührung, dadurch kommt neben den allgemein bei Werkzeugstählen auftretenden Belastungen noch die thermische Belastung hinzu.

Warmarbeitsstähle zeichnen sich besonders durch hohe Wärmezähigkeit, hohe Warmfestigkeit, gute Brandrissbeständigkeit und hohem Warmverschleißwiderstand aus.

Schnellarbeitsstahl

Den Schneidstoffen bzw. Werkzeugen aus Schnellarbeitsstahl kommt speziell in der metallverarbeitenden Industrie eine dominierende Rolle zu.

Schnellarbeitsstahl zeichnet sich durch hohe Verschleißfestigkeit, hohe Arbeitshärte, ausreichende Zähigkeit, hohe Anlassbeständigkeit und hohe Wärmehärte aus und lassen Arbeitstemperaturen bis zu 600°C zu. Sie werden hauptsächlich für Werkzeuge zur spanenden sowie schneidenden Bearbeitung verwendet

Pullvermetallurgische Stähle

Härter, zäher, verschleißfester - pulvermetallurgisch hergestellte Werkzeugstähle erlauben höchste Legierungsgehalte ohne wesentliche Einschränkungen der mechanischen Eigenschaften wie bei vergleichbaren konventionellen Legierungslagen. Aufgrund ihres aufwendigen Fertigungsverfahrens wird eine homogene, seigerungs- und fehlerfreie Struktur erzeugt.

Pullvermetallurgische Stähle zeichnen sich durch hohe Zähigkeit, höchste Verschleißfestigkeit, hohe Arbeitshärte und hohe Werkzeuglebensdauer aus.

Hartmetall

Bei richtiger Anwendung kann die Standzeit um ein vielfaches erhöht werden. Aufgrund der Temperaturbeständigkeit von Hartmetallen, die bis etwa 900 °C reicht, sind dreimal höhere Schnittgeschwindigkeiten möglich. Die Gesamtkosten sind höher als bei anderen Qualitäten, deshalb empfehlen wir einen Kosten- Leistungsvergleich.

Cold-work steel

Cold-work steel is a type of tool steel that is generally resistant to application surface temperatures up to 200 °C. The strengths of cold-work steel are its high hardness, high wear resistance, good toughness, and good dimensional stability while still remaining adequately workable.

Hot-work steel

Hot work tool steel featuring excellent hot tensile properties, high hot wear resistance, adequate toughness and heat checking resistance.

High-speed steel

The cutting materials and tools made of high-speed steel play a dominant role in the metalworking industry in particular.

High-speed steel is characterized by high wear resistance, a high processing hardness, adequate toughness, high resistance to tempering, and high red hardness, and can withstand operating temperatures of up to 600 °C. They are used primarily in tools used in machining or cutting processes.

Powder-metallurgical steel

Harder, tougher, more resistant to wear - tool manufactured steels made by the powder metallurgy process allow the highest possible alloy content without major restrictions to the mechanical properties, in contrast to comparable conventional alloy levels. Due to the complex manufacturing process required, a homogeneous structure free of segregation and defects is produced.

Powder-metallurgical steels are characterized by high toughness, the highest possible wear resistance, high processing hardness, and long tool lives.

Tungsten carbide steel

If used correctly, the tool life can be increased many times over. Due to the temperature resistance of TUNGSTEN CARBIDE, which reaches up to about 900 °C, therefore three times higher cutting speeds are possible.

The total costs are higher than for all other qualities.

Therefore costs and efficiency should be compared.

Für Anwendungen z.B.:

Papier (Schleif- und Schmirgelpapiere)
Pappe
Kunststoff
Folien
Klebebänder
Textilien
Glasfasern

- Flache-, - und gezahnte Kreismesser
- Quetschkreismesser

Hochlegierte Chromstähle- (12%) Werkzeugstahlqualität und rost- und säurebeständige Werkzeugstahlqualität:

Fassco „F-431“ und Fassco „F-412“ zeichnen sich durch höhere Verschleißfestigkeit und Korrosionsbeständigkeit aus.

Zum Beispiel aus kreuzgewalzten Stahlblechen und Rundstähle hergestellt

Für Anwendungen z.B.:

Pappe
Papphülsen
Perforationsmesser für Papier-, Kartonagen- und Verpackungsindustrie
Tapetenindustrie
Kunststoff- und Folienverarbeitung,
Lebensmittelverpackungsindustrie
Krepp-, Gewebe-, Textilschnitt

- Flache- (Hülsenkreismesser), - Kreismesser,
- Mehrkant- (Vierkant- und Bogen-) Kreismesser

Schnellarbeiterstahlqualität (HSS) und pulvermetallurgischen Hochleistungsstähle:

Fassco „F-605“ und Fassco „F-4002“

Zum Beispiel aus kreuzgewalzte Stahlbleche und Rundstähle hergestellt

Für Anwendungen z.B.:

Pappe
dickwandige Papphülsen Hülsenkreismesser,
Papier-, Kartonagen- und Verpackungsindustrie
Kunststoff- und Metallverarbeitung
Teppich- und Hartfaserplatten

Fassco „F-8000“

Hartmetallqualität

Diese allgemein bekannte Qualität empfehlen wir zum Schneiden von Großserien bei immer gleichen Anforderungen.

Examples of use:

papers-(emery- and clothpaper)
foils
plastics
adhesives tapes
textiles
glassfibre products

- Flat- Circular Knives, - and Toothed- Circular Knives
- Crush- Circular Knives

High Chromium Steel (12%) Quality:

and Corrosion-Resistant Cutting Steel Quality:

Fassco „F-431“ und Fassco „F-412“

for example made of: cross-rolled steel sheets and round bar steel

Examples of use:

papers- (emery- and clothpaper)
foils
plastics
adhesives tapes
textiles and glassfibre products
cardboard
cardboard tubes
perforating tissue paperindustry

- Flat- (Circular Tubesknives), - Special knives for the paper-, packaging- and printing industries,
- Multi-edge (square and curved) Circular Knives

High-speed steel (HSS) and Powder-metallurgical steels:

Fassco „F3000“ und Fassco „F4002“

for example made of: cross-rolled steel sheets and round bar steel

Exsamples of use:

Paper
carton
cardboard and cardboard tubes
wood, metal and plastics processing
carpet and hardboard panels

Fassco „F-8000“

Tungsten carbide quality

We recommend this well-known quality for cutting serial production with always the same high quality.

Quetschmesser

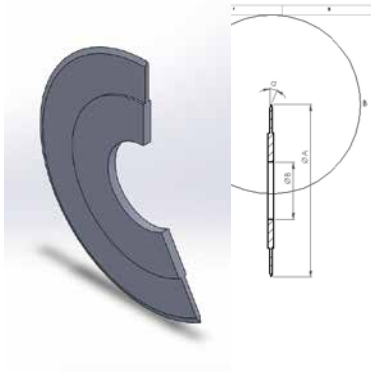

Topfmesser

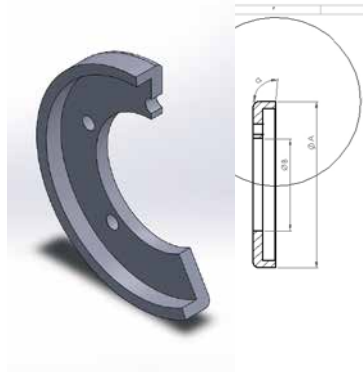

Zwischenringe

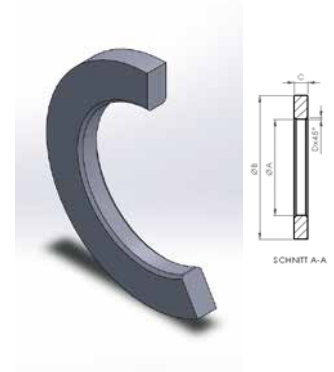

Nutmesser

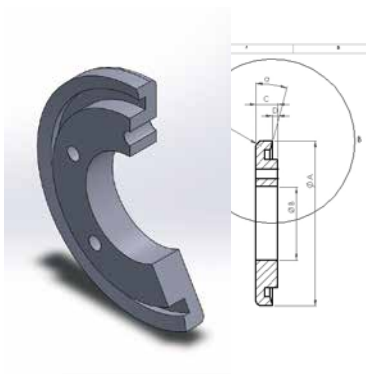

Doppelnutmesser

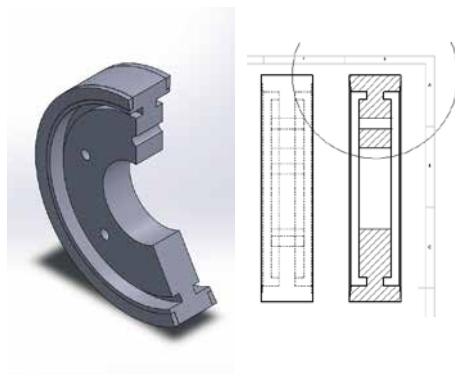

Tellermesser

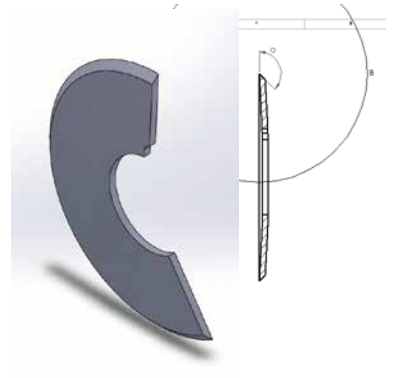
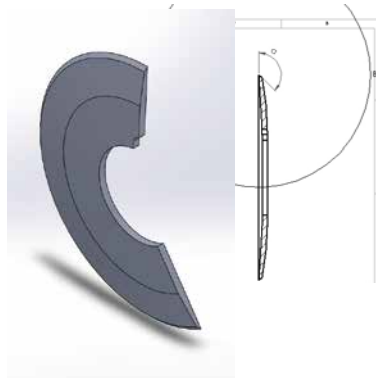
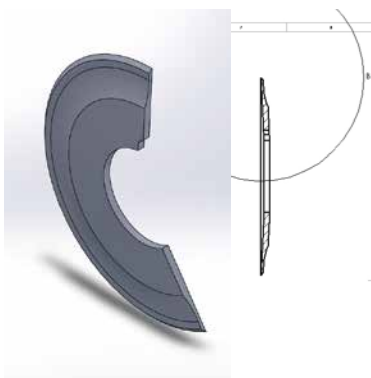

Obermesser

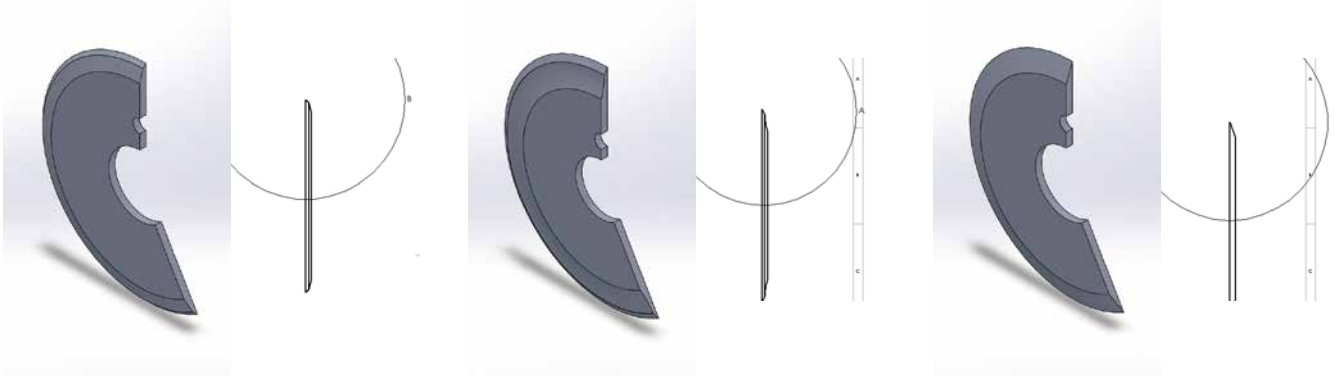

Untermesser

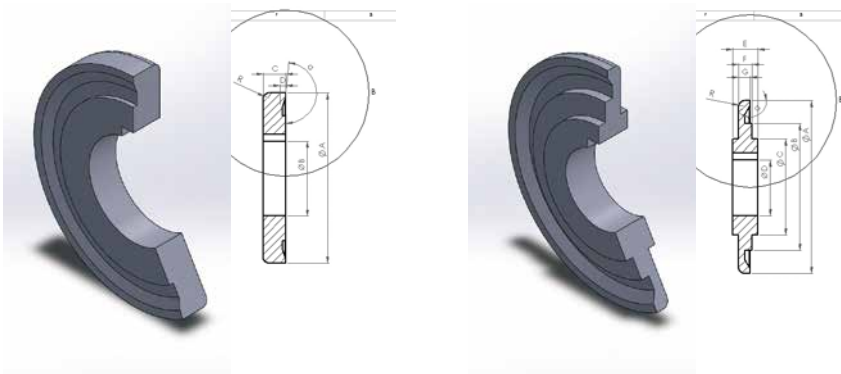

Kreismesser verzahnt



STANDARD-VERPACKUNGEN

STANDARD PACKING



für Stahl-Messer
for Steel knives

| FASSCO Nr./No. | | Größe / Size Dimension / Tamaño | ⚖ kg | €/Stück Pce./Pce./Pza. |
|----------------|-----|------------------------------------|---------|---------------------------|
| VK056 | T/D | 60 cm | 3,40 | 19,00 |
| VK058 | T/D | 62 cm | 4,65 | 21,00 |
| VV065 | P | 65 cm | 1,20 | 12,00 |
| VV072 | P | 72 cm | 1,70 | 14,00 |
| VV088 | P | 88 cm | 2,50 | 16,00 |
| VV110 | P | 110 cm | 4,20 | 18,50 |
| VV140 | P | 140 cm | 5,50 | 22,00 |
| VV160 | P | 162 cm | 6,20 | 25,50 |
| VV200 | P | 200 cm | 8,20 | 33,00 |
| VV250 | P | 250 cm | 10,20 | 42,00 |
| VV300 | P | 300 cm | 12,30 | 47,00 |

für Hartmetall-Messer
for Carbide knives

| FASSCO Nr./No. | | Größe / Size Dimension / Tamaño | ⚖ kg | €/Stück Pce./Pce./Pza. |
|----------------|-----|------------------------------------|---------|---------------------------|
| VH060 | T/D | 60 cm | 3,30 | 20,00 |
| VH125 | P | 126 cm | 4,40 | 33,00 |
| VH155 | P | 156 cm | 5,20 | 33,00 |
| VH170 | P | 170 cm | 6,60 | 36,00 |
| VH200 | P | 200 cm | 6,80 | 36,00 |
| VH230 | P | 230 cm | 7,40 | 44,00 |
| VH250 | P | 250 cm | 7,90 | 50,00 |
| VH275 | P | 275 cm | 9,80 | 58,00 |
| VH300 | P | 304 cm | 13,40 | 59,00 |

T = für Trimmermesser / for trimmer knives
D = für Dreischneider / for three knife trimmers
P = für Planschneider / for face trimmer knives



VERKAUFS- UND LIEFERUNGSBEDINGUNGEN

Vertragsabschluß:

Alle Angebote sind freibleibend. Alle Vereinbarungen werden erst durch unsere schriftliche Bestätigung rechtswirksam. Für alle eingehenden und zukünftigen Aufträge sind ausschließlich diese Bedingungen maßgebend, soweit nicht schriftlich etwas Abweichendes vereinbart ist. Auf Grund von formularmäßigen Bedingungen des Auftraggebers erteilte Aufträge gelten, auch wenn wir diese Bedingungen nicht ausdrücklich ablehnen, stets als zu unseren Bedingungen zustande gekommen. Grundsätzlich werden unsere Bedingungen durch die Annahme der Ware anerkannt.

Preise:

Von uns bestätigte Preise sind als feststehend (bindend) gedacht. Bei einschneidenden wirtschaftlichen Veränderungen, z.B. bei Lohn- und Materialpreiserhöhungen oder höherer Gewalt, müssen wir uns jedoch vorbehalten, unsere Preise den neuen Verhältnissen anzupassen. Falls kein besonderes Angebot von uns erteilt wurde, sind wir berechtigt, die günstigsten Tagespreise, auch bei Lohnarbeiten, zu berechnen. Unsere Preise gelten ab Werk, ausschließlich Verpackung, evtl. Franko-Lieferung muß besonders vereinbart werden.

Versand, Gefahrübergang:

Verpackung, Versand und Transportmittel sind mangels besonderer Vereinbarung unserer Wahl überlassen. Die Verpackung wird selbstkostend berechnet, aber nicht zurückgenommen. Der Versand erfolgt stets auf Gefahr des Bestellers, sobald die Waren dem Transportunternehmen übergeben sind, auch dann, wenn Franko-Lieferung vereinbart worden ist. Wir sind zu Teillieferungen in zumutbarem Umfang berechtigt. Branchenübliche Mehr- oder Minderlieferung der abgeschlossenen Menge sind zulässig.

Lieferzeit:

Die angegebenen Lieferzeiten lauten unverbindlich; Schadenersatzansprüche wegen verspäteter Lieferung sind ausgeschlossen.

Zahlungsbedingungen:

Unsere Rechnungen sind, wenn nichts anderes vermerkt, grundsätzlich 30 Tage nach Rechnungsdatum zur Zahlung fällig, ohne dass es einer besonderen Mahnung bedarf. Die Zahlungen sind in EURO ohne jeden Abzug frei Zahlstelle des Lieferers in bar, spätestens 30 Tage nach Rechnungsdatum - auch bei Teillieferung - zu leisten. Barzahlungsnachlässe von 2% werden nur dann eingeräumt, wenn die Zahlung unverzüglich nach Lieferung der Ware, spätestens innerhalb 10 Tagen ab Rechnungsdatum in bar, durch Scheck oder Überweisung erfolgt. Bei späterer Zahlung können Barzahlungsnachlässe nicht gewährt werden. Auf Reparaturen und Lohnarbeiten werden keine Barzahlungsnachlässe gewährt. Die Annahme von Wechseln und Schecks erfolgt nur zahlungshalber, die Kosten der Diskontierung und Einziehung trägt der Käufer. Die Gutschrift erfolgt mit der Wertstellung, an dem der Betrag für uns zur Verfügung steht. Bei Zahlungsverzug, der auch ohne besondere Mahnung eintritt, werden unter dem Vorbehalt der Geltendmachung eines weiteren Schadens, Zinsen in banküblicher Höhe berechnet. Lieferung an unbekannte Firmen erfolgt nur gegen Voreinsendung des Betrages oder unter Nachnahme als Wertsendung. Sonderwerkzeuge werden an solche Firmen nur gegen entsprechende Anzahlung geliefert, wobei die Verrechnung der Anzahlung bei der Restlieferung erfolgt. Verschlechterung der Zahlungsfähigkeit des Käufers oder die Nichteinhaltung der vereinbarten Zahlungsbedingungen berechtigen uns zu deren Änderung. Bei Zahlungseinstellung oder Konkurs des Käufers ist die Kaufpreisforderung sofort fällig. Die Zurückhaltung der Zahlungen oder Aufrechnung wegen irgendwelcher Gegenansprüche des Käufers sind ausgeschlossen.

Eigentumsvorbehalt:

Alle gelieferten Waren bleiben bis zur restlosen Erfüllung unserer sämtlichen Ansprüche unser Eigentum (Vorbehaltsware), auch wenn Zahlungen für besonders bezeichnete Forderungen geleistet werden. Der Käufer darf die Vorbehaltsware nur im gewöhnlichen Geschäftsverkehr, solange er nicht im Verzug ist, weiterveräußern oder verarbeiten bzw. in Maschinen einbauen. Die Forderungen des Käufers aus der Weiterveräußerung der Vorbehaltsware, nebst allen Nebenrechten, werden bereits jetzt, und zwar gleich, ob sie an einen oder mehrere Abnehmer veräußert wird, in voller Höhe an uns abgetreten. Beim Einbau von Werkzeugen in Maschinen erwerben wir automatisch Miteigentum an der betreffenden Maschine. Eine Verpfändung oder Sicherungsübereignung der Ware ohne unsere Zustimmung vor endgültiger Bezahlung ist nicht statthaft.

Mängelrüge und Gewährleistung:

Mängelrügen müssen unverzüglich nach Eingang der Waren schriftlich bei uns eingehen. Beanstandungen, die nach 8 Tagen nach Empfang der Waren bei uns eingehen, können nicht berücksichtigt werden. Bemängelte Waren sind zur Untersuchung franko einzusenden. Bei begründeten Reklamationen behalten wir uns vor, nach vorausgegangener Franko-Rücksendung kostenfreien Ersatz zu liefern, lehnen jedoch jede weiteren Ansprüche ab.

Erfüllungsort und Gerichtsstand:

Erfüllungsort für Lieferung und Zahlung sowie Gerichtsstand ist Remscheid. Der Vertrag bleibt auch bei Unwirksamkeit einzelner Punkte seiner Bedingungen verbindlich und führt nicht zur Nichtigkeit der gesamten Bedingungen und entbindet den Käufer nicht von seinen sonstigen Verpflichtungen.



Fassbender GmbH & Co. KG

Maschinenmesser-Fabrik

Machine Knives Manufacturer

Fürberg 9

D-42857 Remscheid | Germany

Phone +49 (0) 21 91 / 20 995-0

Fax +49 (0) 21 91 / 20 995-20

www.fassco.de | info@fassco.de



www.fassco.de